

**GOVERNMENT POLYTECHNIC
BHUBANESWAR**



**LECTURE NOTES
ON
ENERGY CONVERSION-II
(TH-2)
SEM:5TH SEM**

Department of Electrical Engineering

PREPARED BY- SUNITA ORAM (Lect. EE)

CHAPTER -1

ALTERNATOR

Introduction

An alternator is an electromechanical device that converts mechanical energy to electrical energy in the form of alternating current. Synchronous generators are also called as alternators.

A.C. generators are used in to generate electricity in hydroelectric and thermal plants. Alternators are also used in automobiles to generate electricity.

Like a D.C. generator, an alternator also has an armature winding and a field winding.

But there is one important difference between the two.

- In D.C. generators, the field poles are stationary and the armature conductors rotate. The voltage generated in the armature conductors is of alternating nature. This generated alternating voltage is converted to a direct voltage at the brushes with the help of the commutator.
- But in the synchronous generator it is convenient and advantageous to place the field winding on the rotating part (i.e., rotor) and armature winding on the stationary part (i.e., stator). No commutator is required in an alternator

Advantages of Stationary Armature:

Most alternators have the rotating field and the stationary armature. The rotating-field type alternator has several advantages over the rotating-armature type alternator.

1. A stationary armature is more easily insulated for the high voltage for which the alternator is designed. This generated voltage may be as high as 33K V.
2. The armature windings can be fixed better mechanically against high electromagnetic forces due to large short-circuit currents when the armature windings are in the stator.
3. The armature windings, being stationary, are not subjected to vibration and centrifugal forces.
4. The output current can be taken directly from fixed terminals on the stationary armature without using slip rings, brushes, etc.
5. Only two slip rings are required for d.c. supply to the field winding on the rotor.
6. The stationary armature may be cooled more easily because the armature can be made large to provide a number of cooling ducts.

Types of synchronous machines:

According to the arrangement of armature and field winding, the synchronous machines are classified as **rotating armature type** or **rotating field type**.

- In **rotating armature type** the armature winding is on the rotor and the field winding is on the stator. The generated EMF or current is brought to the load via the slip rings. These type of generators are built only in small units.
- In case of **rotating field type** generators field windings are on the rotor and the armature windings are on the stator. Here the field current is supplied through a pair of slip rings and the induced EMF or current is supplied to the load via the stationary terminals.

Based on the type of the prime movers employed the synchronous generators are classified as

1. **Hydro generators:** The generators which are driven by hydraulic turbines are called hydro generators. These are run at lower speeds less than 1000 rpm.
2. **Turbo generators:** These are the generators driven by steam turbines. These generators are run at very high speed of 1500rpm or above.
3. **Engine driven Generators:** These are driven by IC engines. These are run at speed less than 1500 rpm.

Construction of Alternator:

An alternator consists of two main parts namely, the

- i. stator
- ii. rotor

The stator is the stationary part of the machine. It carries the armature winding in which the voltage is generated. The output of the machine is taken from the stator. The rotor is the rotating part of the machine. The rotor produces the main field flux.

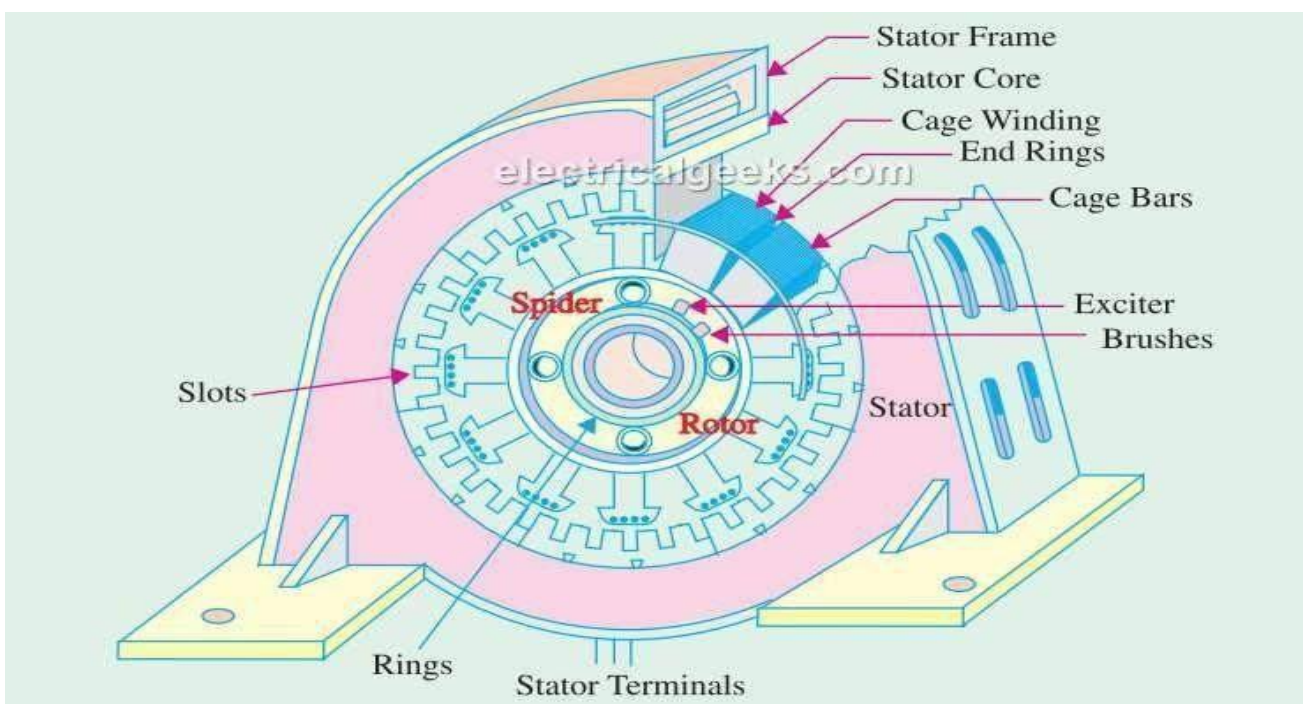

Stator Construction:

The Stationary part of the alternator is known as stator. It provides housing and support for the rotor. Stator is built up of sheet-steel laminations having slots on its inner periphery. A 3-phase winding is placed in these slots and serves as the armature winding of the alternator.

The armature winding is always connected in star and the neutral is connected to ground.

The stator is the outer stationary part of the machine, which consists of

- The outer cylindrical frame called yoke, which is made either of welded sheet steel, cast iron.
- The magnetic path, which comprises a set of slotted steel laminations called stator core pressed into the cylindrical space inside the outer frame. The magnetic path is laminated to reduce eddy currents, reducing losses and heating.

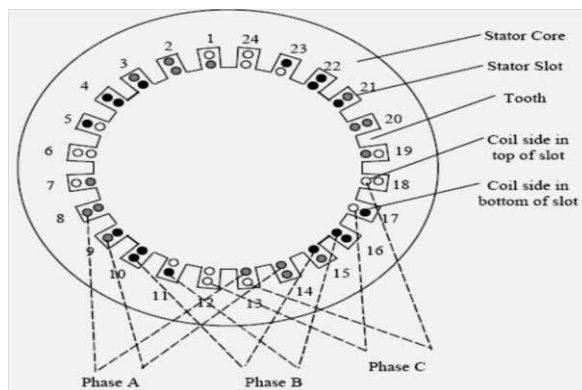

Rotor Construction:

The rotor carries a field winding which is supplied with direct current through two slip rings by a separate d.c. source. This d.c. source (called exciter) is generally a small d.c. shunt or compound generator mounted on the shaft of the alternator.

There are two types of rotor constructions namely,

- i. Salient (or projecting) pole type
- ii. Non salient (or Cylindrical) pole type.

Salient (or projected) pole type.

- The pole is made of steel or cast iron and the pole winding is excited by a D.C. generator driven by the shaft of alternator.
- These type of machines have salient pole or projecting poles with concentrated field windings. This type of construction is for the machines which are driven by hydraulic turbines or Diesel engines.
- The salient pole type of rotor is used for low to medium speed/rpm alternators, where more number of poles are required may be 20 or 30 poles.
- A salient pole alternator can be identified by large diameter and short axial length. The large diameter accommodates a large number of poles.
- A salient-pole synchronous machine has a non-uniform air gap. The air gap is minimum under the pole centres and it is maximum in between the poles.
- Salient-pole alternators driven by water turbines are called hydro-alternators or hydro-generators.

Damper windings are provided in the pole faces of salient pole alternators. Damper windings are nothing but the copper or aluminium bars housed in the slots of the pole faces. These

damper windings are serving the function of providing mechanical balance; provide damping effect, reduce the effect of over voltages and damp out hunting in case of alternators.

Salient pole type rotor

Non salient (or cylindrical or Round) pole type:

- The rotor is made of steel cylinder with number of slots cut on the periphery of the cylinder. The field windings are placed in the slots.
- These machines are having cylindrical smooth rotor construction with distributed field winding in slots.
- Cylindrical pole type of rotor construction is employed for the machine driven by steam turbines.
- These cylindrical pole type alternators have large axial length and smaller diameter.
- Cylindrical rotors are particularly useful in high-speed machines. The cylindrical rotor type alternator has two or four poles on the rotor. Such a construction provides a greater mechanical strength and permits more accurate dynamic balancing.
- The cylindrical rotor machine makes less windage losses and the operation is less noisy because of uniform air gap.

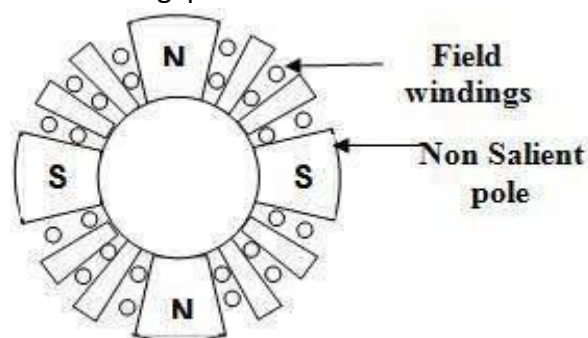

Smooth cylindrical or non salient type rotor

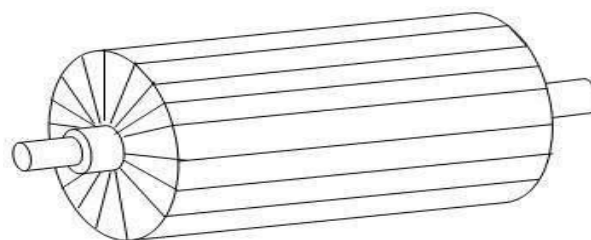

3D view of smooth cylindrical or non-salient type rotor

Working Principle of Alternator:

An alternator operates on the same fundamental principle of *electromagnetic Induction* as a D.C. generator i.e., when the flux linking a conductor changes, an e.m.f. is induced in the conductor.

Field windings are the windings producing the main magnetic field (rotor windings for synchronous machines); armature windings are the windings where the main voltage is induced (stator windings for synchronous machines).

The rotor winding is energized from the d.c. exciter to produce a rotor magnetic field and alternate N and S poles are developed on the rotor. When the rotor is rotated in anti-clockwise direction by a prime mover, the stator or armature conductors are cut by the magnetic flux of rotor poles. Consequently, e.m.f. is induced in the armature conductors due to electromagnetic induction. The induced e.m.f. is alternating since N and S poles of rotor alternately pass the armature conductors. The direction of induced e.m.f. can be found by Fleming's right hand rule and frequency is given by;

$$f = \frac{PN}{120} \text{ where } N = \text{speed of rotor in r.p.m}$$

P=number of rotor poles

When the rotor is rotated, a 3-phase voltage is induced in the armature winding. The magnitude of induced e.m.f. depends upon the speed of rotation and the d.c.exciting current. The magnitude of e.m.f. in each phases of the armature windings is the same.

Fleming's Right hand rule:

Statement: The thumb, fore finger and middle finger of the right hand are stretched to be perpendicular to each other and if the thumb represents the direction of the movement of conductor, fore-finger represents direction of the magnetic field, then the middle finger represents direction of the induced emf.

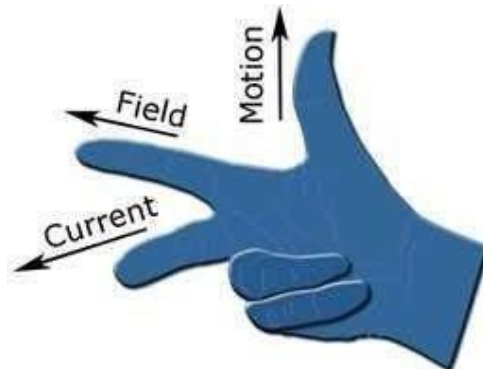

Relation between speed and frequency:

The frequency of induced e.m.f in the armature conductors depends upon speed & the number of poles.

Let N=rotor speed in r.p.m

P= number of rotor poles

f =frequency of emf in

HZ

- ❖ Armature (stator) conductor successively swept by N & S poles of the rotor. If a positive voltage is induced when a N-pole sweeps across the conductor, similarly negative voltage is induced when a S-pole sweeps by.

That is one complete cycle of e.m.f is generated in the conductor as a pair of poles passes it i.e., one N-pole and the adjacent following S-pole.

No of cycles/revolution = No. of pair of poles = $P/2$

No of revolution/second = $N/60$

No. of cycles/second = $(P/2)(N/60)$

But no. of cycles of e.m.f per second is its frequency.

$$\text{So } f = \frac{PN}{120} \quad \text{where } N = \text{speed of rotor in r.p.m}$$

P = number of rotor poles

For a given alternator, P is fixed, therefore, the alternator must be run at synchronous speed to give an output of desired frequency. For this reason the alternator is also called as *synchronous generator*.

Terminology in Armature Winding:

Conductor: Each individual length of wire lying in the magnetic field is called conductor.

Turn: When the two conductors lying in the magnetic field are connected in series, so that the emf induced in them help each other or the resultant induced emf becomes double of that due to one conductor is called turn.

Coil: When one or more turns are connected in series and two ends of it are connected to the adjacent commutator segments it is called a coil.

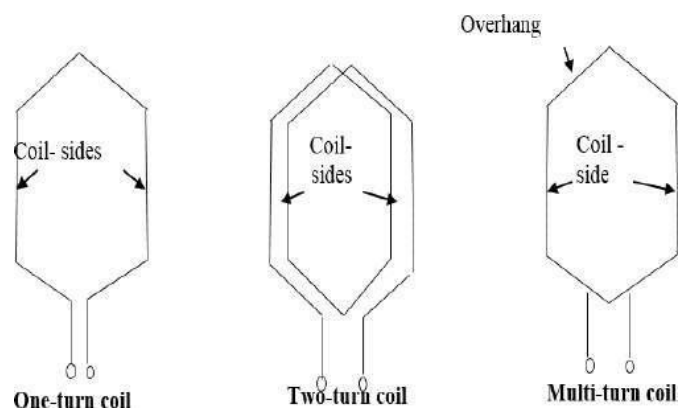

Pole Pitch: A pole pitch is defined as the peripheral distance between two adjacent poles.

Or

The pole pitch is defined as distance is measured in term of armature slots or armature conductors per pole. Pole pitch is always equal to 180° electrical.

Coil Span or Coil Pitch: The distance between the two coil-sides of a coil is called coil-span or coil-pitch. It is usually measured in terms of teeth, slots or electrical degrees.

Windings in Alternators: In case of three phase alternators the following types of windings are employed.

❖ **Based on type of winding connections,** the armature winding of Alternator are of two types.

- Lap winding.
- Wave winding.

Lap winding of an Alternator:

In this type of winding the finishing end of one coil is connected to a commutator segment and to the start end of adjacent coil located under the same pole and similarly all coils are connected. This type of winding is known as lap because the sides of successive coils overlap each other. The purposes of such type of windings are,

- To increase the number of parallel paths enabling the armature current to increase i.e., for high current output.
- To improve commutation as the current per conductor decreases.

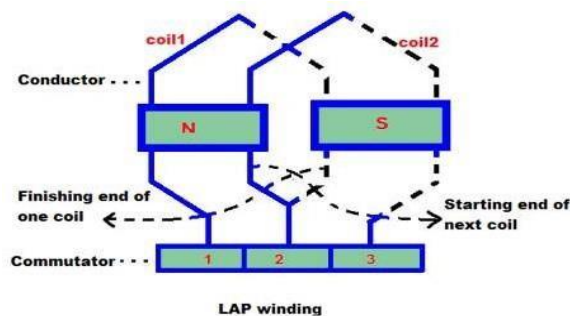

Wave winding of Alternator:

In wave winding the coils which are carrying current in one direction are connected in series circuit and the carrying currents in opposite direction are connected in another series circuit. In wave winding, the conductors are so connected that they are divided into two parallel paths irrespective of the number of poles of the machine. Thus, if the machine has Z armature conductors, there will be only two parallel paths each having $Z/2$ conductors in series. In this case number of brushes is equal to two, i.e. number of parallel paths.

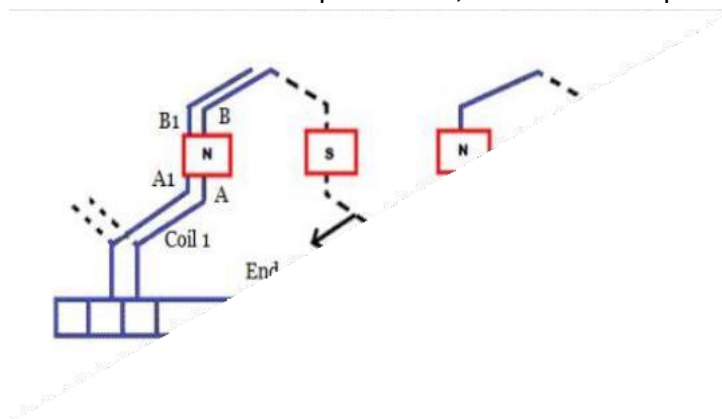

❖ Based on pitch of the coil

- full pitched
- short pitched

Full Pitched Coil:

If the coil-span (or coil-pitch) is equal to the pole-pitch, then the coil is termed a **full-pitch coil**. In this situation, two opposite sides of the coil lie under two opposite poles. Hence emf induced in one side of the coil will be in 180° phase shift with emf induced in the other side of the coil. Thus, the total terminal voltage of the coil will be the arithmetic sum of these two emfs.

Short Pitched Coil:

If the coil span is less than the pole pitch, then the winding is referred as **short pitched coil** or **fractional pitched**. In this coil, there will be a phase difference between induced emf in two sides, less than 180° . Hence resultant terminal voltage of the coil is vector sum of these two emf's and it is less than that of full-pitched coil.

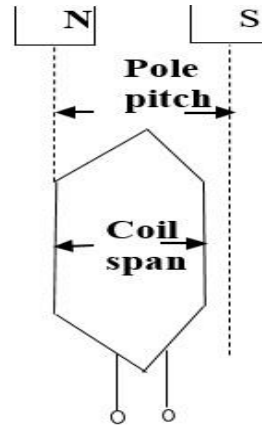
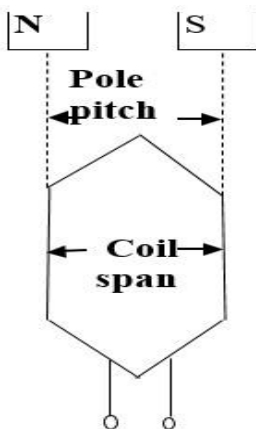

Full-pitch coil

- ❖ Based on number of layers
 - Single layer
 - Double layer

Short-pitched or chorded coil

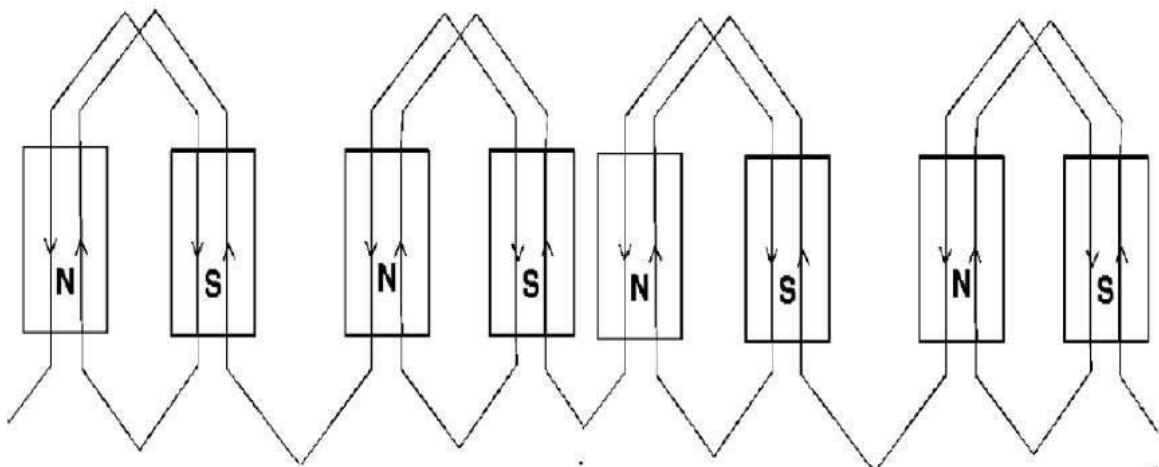

Single layer Winding

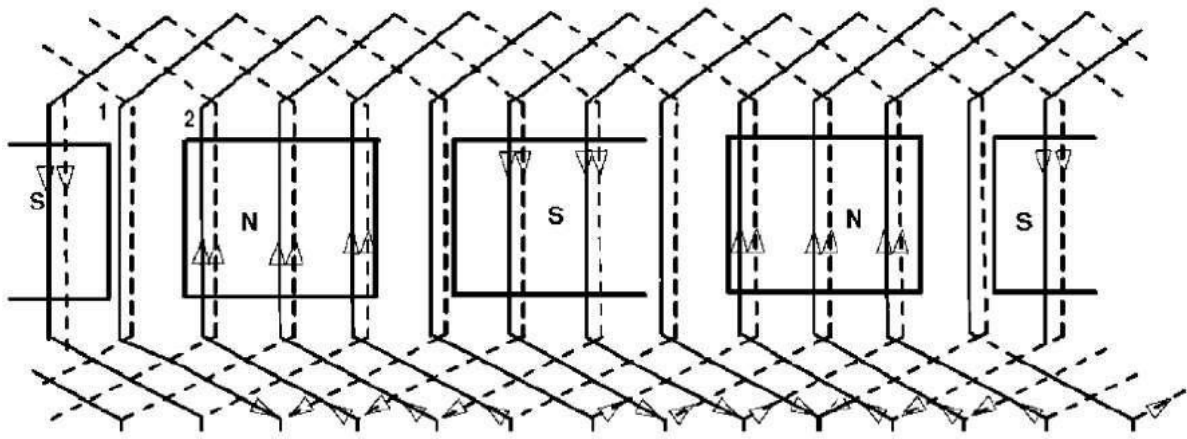

Double layer winding

❖ **Based on distribution of windings**

- Concentrated winding
- Distributed winding

Concentrated winding

- ❖ A winding with only one slot per pole per phase is called a concentrated winding.
- ❖ In this type of winding, the e.m.f. generated/phase is equal to the arithmetic sum of the individual coil e.m.f.s in that phase.

Examples of concentrated winding are

- field windings for salient-pole synchronous machines
- D.C. machines
- Primary and secondary windings of a transformer

Distributed winding:

- ❖ If the coils/phase are distributed over several slots in space, then it is called distributed winding.
- ❖ The e.m.f.s in the coils are not in phase (i.e., phase difference is not zero) but are displaced from each by the slot angle α (The angular displacement in electrical degrees between the adjacent slots is called slot angle).
- ❖ The e.m.f./phase will be the phasor sum of coil e.m.f.s.

Examples of distributed winding are

- Stator and rotor of induction machines
- The armatures of both synchronous and D.C. machines

Winding factors:

Pitch Factor:

The ratio of phasor (vector) sum of induced emfs per coil to the arithmetic sum of induced emfs per coil is known as **pitch factor (K_p)** or **coil span factor (K_c)** which is always less than unity.

$$K_p = \frac{\text{Phasor sum of coilside emfs}}{\text{Arithmetic sum of coilside emfs}}$$

Expression for K_p .

Consider a coil AB which is short-pitch by angle β electrical degrees. The e.m.f.s generated in the coil sides A and B differ in phase by an angle β and can be represented by phasors E_A and E_B respectively. The diagonal of the parallelogram represents the resultant e.m.f. E_R of the coil.

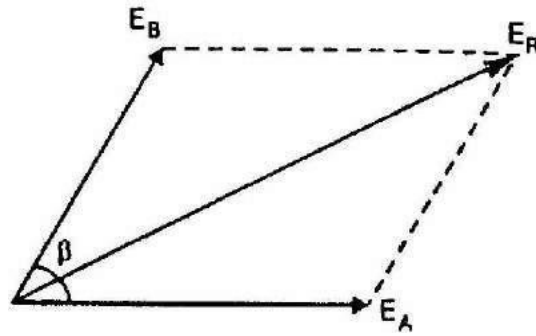

Since $E_A = E_B$, $E_R = 2E_A \cos(\beta/2)$

$$K_p = \frac{\text{e. m. f. induced in short pitch coil}}{\text{e. m. f. induced in full pitch coil}} = \frac{2E_A \cos(\beta/2)}{2E_A} = \cos(\beta/2)$$

$$K_p = \cos(\beta/2) \quad \text{f. induced in short pitch coil}$$

For a full-pitch winding, $K_p = 1$. However, for a short-pitch winding, $K_p < 1$.

Distribution Factor:

A winding with only one slot per pole per phase is called a concentrated winding. In this type of winding, the e.m.f. generated/phase is equal to the arithmetic sum of the individual coil e.m.f.s in that phase.

However, if the coils/phase are distributed over several slots in space (distributed winding), the e.m.f.s in the coils are not in phase (i.e., phase difference is not zero) but are displaced from each by the slot angle α . The e.m.f./phase will be the phasor sum of coil e.m.f.s.

The ratio of the phasor sum of the emfs induced in all the coils distributed in a number of slots under one pole to the arithmetic sum of the emfs induced (or to the resultant of emfs induced in all coils concentrated in one slot under one pole) is known as **breadth factor (Kb)** or **distribution factor (Kd)**. The distribution factor is always less than unity.

$$K_d = \frac{\text{e. m. f. with distributed windings}}{\text{e. m. f. with concentrated winding}}$$

$$K_d = \frac{\text{Phasor sum of coil emf/phase}}{\text{Arithmetic sum of coil emf/phase}}$$

Expression for K_d :

Slot angle α : The angular displacement in electrical degrees between the adjacent slots is called slot angle

$$\text{Slot angle} = \alpha = \frac{180^\circ}{\text{No. of slots/pole}}$$

m = slots per pole per phase

Let $m=3$. The three coil e.m.f.s are phasors AB, BC and CD each of which is a chord of circle with centre at O and subtends an angle α at O shown in phasor diagram. The phasor sum of the coil e.m.f.s subtends an angle $m\alpha$ ($m=3$) at O. OX, OY perpendicular bisector of AD and AB respectively.

$$K_d = \frac{AD}{m \times AB} = \frac{2 \times AX}{m(2AY)} = \frac{AX}{mAY}$$

$$= \frac{OA \times \sin(m\alpha/2)}{m \times OA \times \sin(\alpha/2)}$$

$$K_d = \frac{\sin\left(\frac{m\alpha}{2}\right)}{m \sin\left(\frac{\alpha}{2}\right)}$$

❖ A group of adjacent slots belonging to one phase under one pole pair is known as **Phase belt**. The angle subtended by a phase belt is known as **Phase spread**.

$$\text{Phase spread} = m\alpha$$

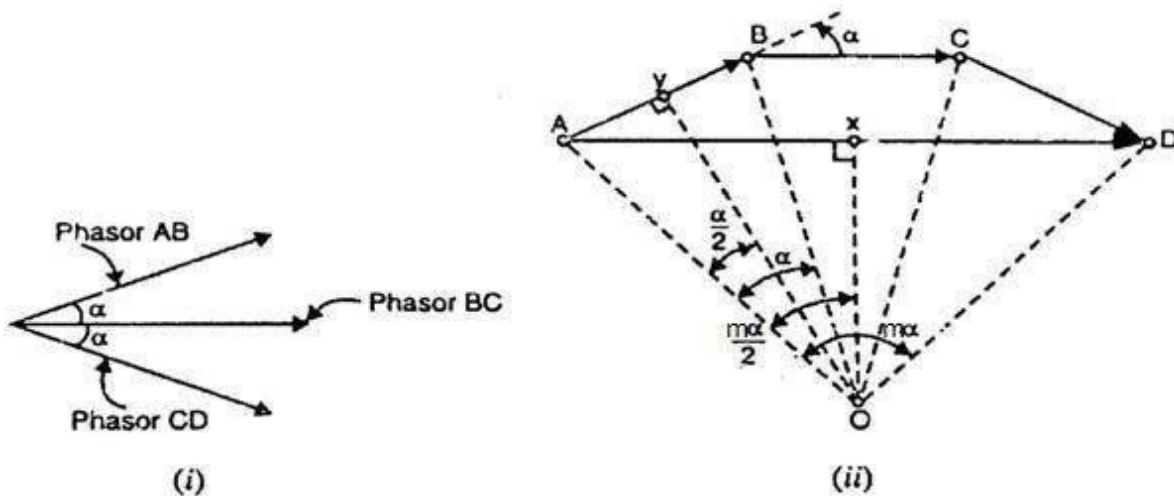

Winding Factor: Both distribution factor (K_d) and pitch factor K_p together is known as **winding factor K_w** .

$$K_w = K_d \times K_p$$

Harmonics:

Harmonics are unwanted higher frequencies which superimposed on the fundamental waveform creating a distorted wave pattern. The sources of harmonics in the output voltage waveform are the non-sinusoidal waveform of the field flux.

When the uniformly sinusoidal distributed air gap flux is cut by either the stationary or rotating armature sinusoidal EMF is induced in the alternator. Hence the nature of the waveform of induced EMF and current is sinusoidal. But when the alternator is loaded waveform will not continue to be sinusoidal or becomes non sinusoidal. Such non sinusoidal wave form is called complex wave form. By using Fourier series representation, it is possible to represent complex non sinusoidal waveform in terms of series of sinusoidal components called harmonics, whose frequencies are integral multiples of fundamental wave.

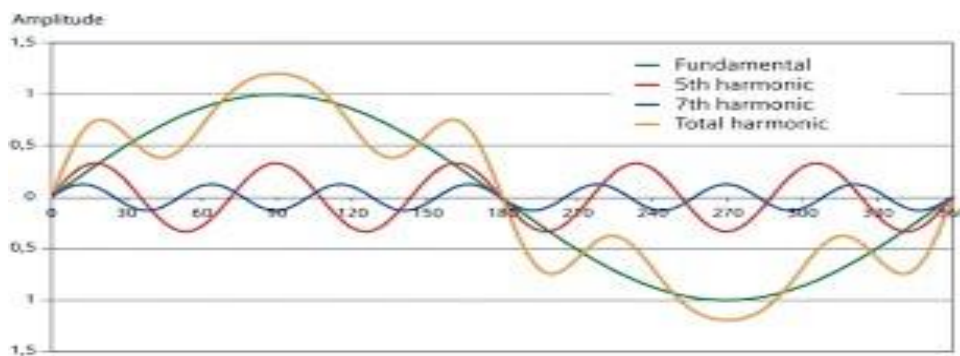

The fundamental wave form is one which is having the frequency same as that of complex wave. The waveform, which is of the frequency twice that of the fundamental is called second harmonic. The one which is having the frequency three times that of the fundamental is called third harmonic and so on. These harmonic components can be represented as follows.

Fundamental: $e_1 = E_{m1} \sin(\omega t \pm \theta_1)$
 2nd Harmonic $e_2 = E_{m2} \sin(2\omega t \pm \theta_2)$
 3rd Harmonic $e_3 = E_{m3} \sin(3\omega t \pm \theta_3)$ 5th
 Harmonic $e_5 = E_{m5} \sin(5\omega t \pm \theta_5)$ etc.

In case of alternators as the field system and the stator coils are symmetrical the induced EMF will also be symmetrical and hence the generated EMF in an alternator will not contain any even harmonics.

Slot Harmonics:

As the armature or stator of an alternator is slotted, some harmonics are induced into the EMF which is called slot harmonics. The presence of slot in the stator makes the air gap reluctance at the surface of the stator non uniform. Since in case of alternators the poles are moving or there is a relative motion between the stator and rotor, the slots and the teeth alternately occupy any point in the air gap. Due to this the reluctance or the air gap will be continuously varying. Due to this variation of reluctance ripples will be formed in the air gap between the rotor and stator slots and teeth. This ripple formed in the air gap will induce ripple EMF called slot harmonics.

Minimization of Harmonics:

To minimize the harmonics in the induced waveforms following methods are employed:

1. Distribution of stator winding: distribution of the armature winding along the air-gap periphery

2. Short Chording: with coil-span less than pole pitch
3. Fractional slot winding
4. Skewing: skew the pole faces if possible
5. Larger air gap length: Small air gap at the pole centre and large air gap towards the pole ends

Effect of Harmonics of pitch and distribution Factor:

- The pitch factor is given by $K_p = \cos \frac{\beta}{2}$, where β is the chording angle.

For any harmonic say n th harmonic the pitch factor is given by

$$K_d = \frac{\left(\frac{m\alpha}{2}\right)}{m \sin\left(\frac{\alpha}{2}\right)} \sin n m \alpha$$

- The distribution factor is given by

For any harmonic say n th harmonic the distribution factor is given by $K_d = \frac{\left(\frac{n\alpha}{2}\right)}{n \sin\left(\frac{\alpha}{2}\right)}$

E.M.F. Equation of an Alternator:

Let Z = No. of conductors or coil sides in series per phase

Φ = Flux per pole in webers

P = Number of rotor poles

N = Rotor speed in r.p.m.

In one revolution (i.e., $60/N$ second), each stator conductor is cut by $P \Phi$, webers i.e.,

$$d\Phi = P \Phi, dt = \frac{60}{N}$$

Average e.m.f. induced in one stator conductor $= \frac{d\Phi}{dt}$

$$= \frac{P\Phi}{60/N} = \frac{P\Phi N}{60}$$

$P \Phi N$
volts

Since there are Z conductors in series per phase,

Average e.m.f./phase $= \frac{P\Phi N}{60} \times Z$

$$= \frac{P\phi Z}{60} \times \frac{120 f}{P} \left[N = \frac{120 f}{P} \right]$$

$$= 2f \phi Z \text{ volts}$$

R.M.S. value of e.m.f./phase = Average value/phase x form factor

$$= 2f \phi Z \times 1.11 = 2.22f \phi Z \text{ volts}$$

$$E_{r.m.s}/P \text{ phase} = 2.22f \phi Z \text{ volts}$$

Since, $Z = 2T$

$$E_{r.m.s}/P \text{ phase} = 4.44f \phi T \text{ volts}$$

This is the general EMF equation for the machine having concentrated and full pitched winding.

If K_p and K_d are the pitch factor and distribution factor of the armature winding, then,

$$E_{r.m.s}/P \text{ phase} = 4.44K_p K_d f \phi T \text{ Volts}$$

Armature Reaction in Alternator:

When an alternator is running at no-load, there will be no current flowing through the armature winding and the flux produced in the air-gap will be only due to the rotor ampere-turns.

When load current flows through the armature windings of an alternator, the resulting mmf produces flux. This armature flux reacts with the main-pole flux, causing the resultant flux to become either less than or more than the original main flux.

The effect of the armature (stator) flux on the flux produced by the rotor field poles is called *armature reaction*.

Two things are worth noting about the armature reaction in an alternator.

- First, the armature flux and the flux produced by rotor ampere-turns rotate at the same speed (synchronous speed) in the same direction and, therefore, the two fluxes are fixed in space relative to each other.
- Secondly, the modification of flux in the air-gap due to armature flux depends on the magnitude of stator current and on the power factor of the load. It is the load power

factor which determines whether the armature flux distorts, opposes or helps the flux produced by rotor ampere-turns.

To illustrate this important point, we shall consider the following three cases:

1. When load P.f. is unity
2. When load P.f. is zero lagging
3. When load P.f. is zero leading **When load Power Factor is**

unity:

Fig:1(a)(i) shows an alternator on no load. Since the armature is on open-circuit, there is no stator current and the flux due to rotor current is distributed symmetrically in the air-gap. Since the direction of the rotor is assumed clockwise, the generated e.m.f. in phase R_1R_2 is at its maximum and is towards the paper in the conductor R_1 and outwards in conductor R_2 . No armature flux is produced since no current flows in the armature winding.

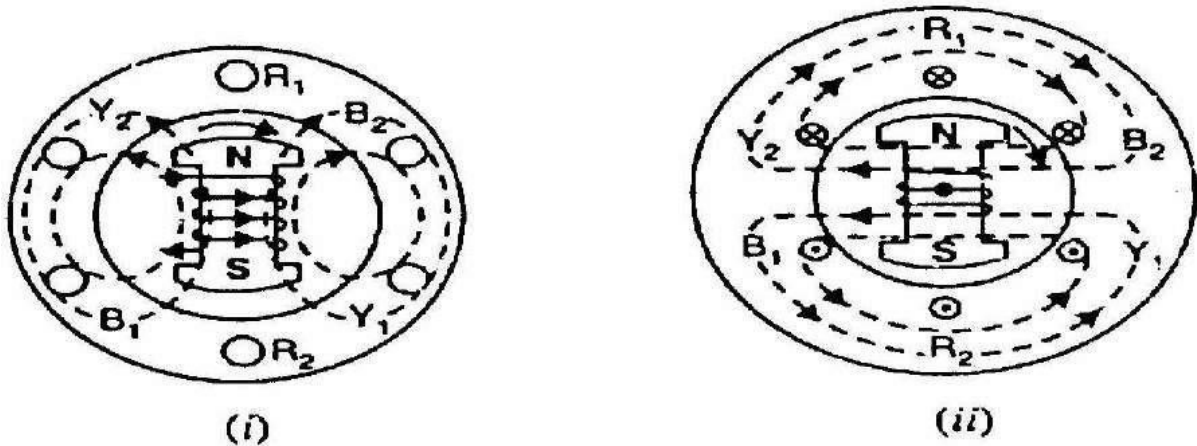
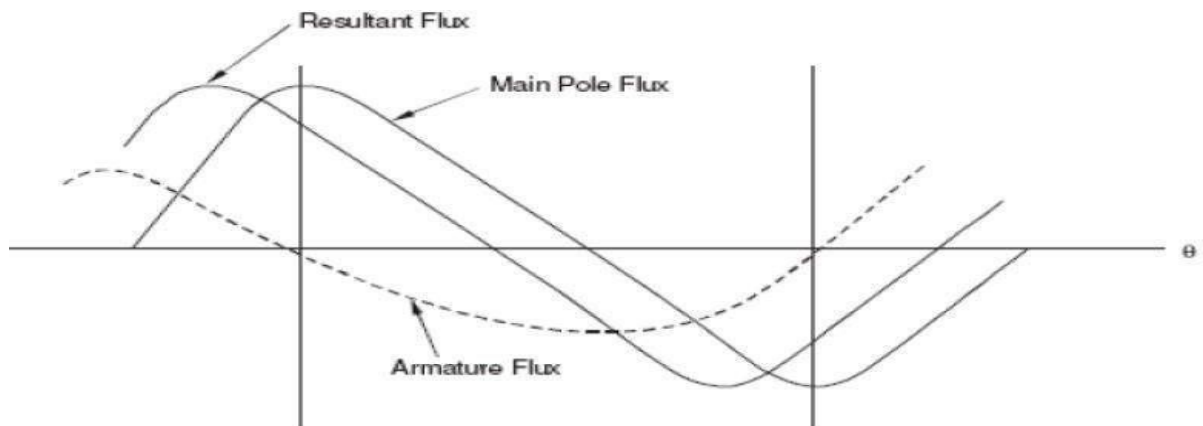

Fig:1(a)

Fig:1(a)(ii) shows the effect when a resistive load (unity p.f.) is connected across the terminals of the alternator. According to right hand rule, the current is “in” in the conductors under N-pole and “out” in the conductors under S-pole. Therefore, the armature flux is clockwise due to currents in the top conductors and anti clockwise due to currents in the bottom conductors. The armature flux is at 90° to the main flux (due to rotor current) and is behind the main flux.

In this case, the flux in the air-gap is distorted but not weakened. Therefore, at unity p.f., the effect of armature reaction is merely to distort the main field; there is no weakening of the main field and the average flux practically remains the same. Since the magnetic flux due to stator currents (i.e., armature flux) rotate; synchronously with the rotor, the flux distortion remains the same for all positions of the rotor.



Distorting effect of armature reaction **When**

load Power Factor is Zero lagging:

When a pure inductive load (zero P.f. lagging) is connected across the terminals of the alternator, current lags behind the voltage by 90° . This means that current will be maximum at zero e.m.f. and vice-versa.

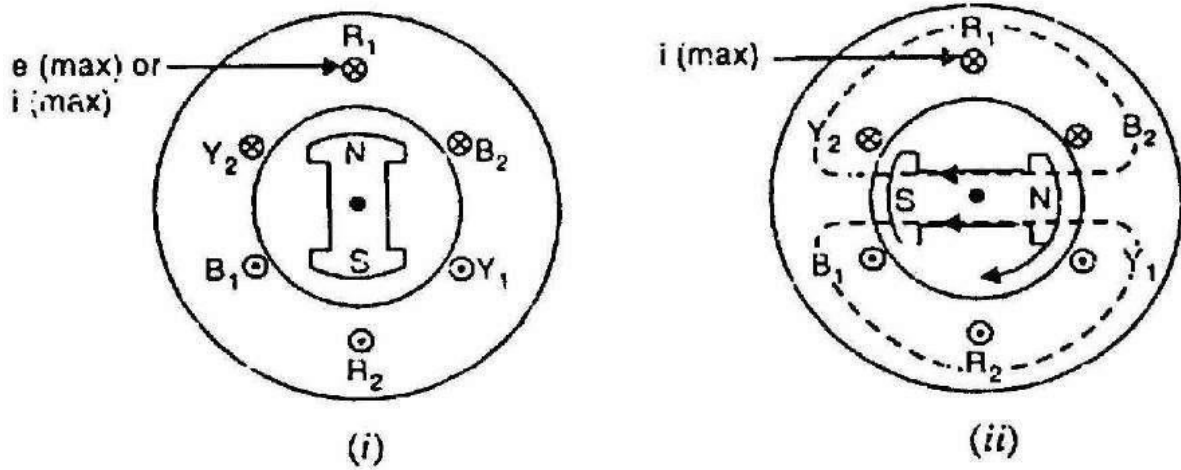
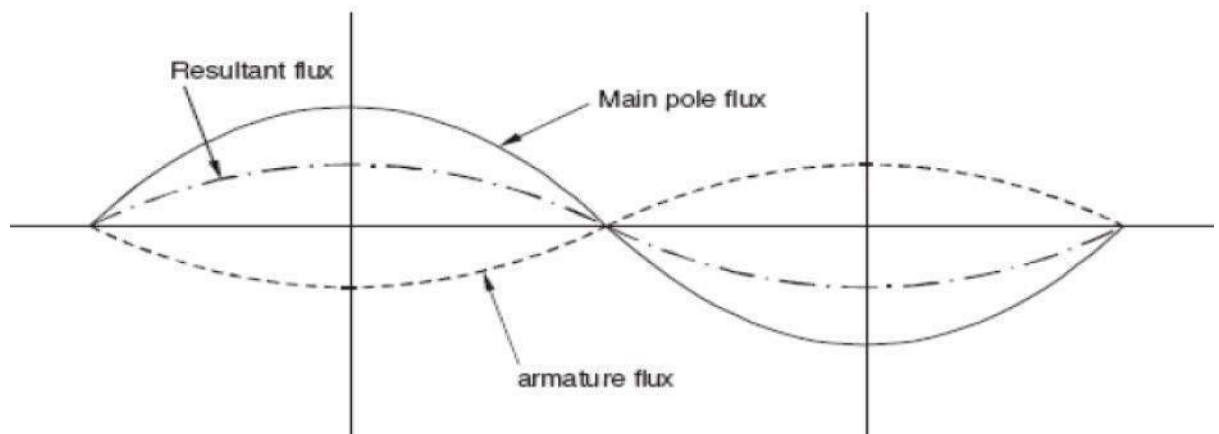

Fig:1(b)

Fig:1(b)(i) shows that in case of Resistive load the e.m.f. as well as current in phase R_1R_2 is maximum. When the alternator is supplying a pure inductive load, the current in phase R_1R_2 will not reach its maximum value until N-pole advanced 90° electrical which is shown in Fig:1(b)(ii). Now the armature flux is from right to left and field flux is from left to right. All the flux produced by armature current (i.e., armature flux) opposes the field flux and, therefore, weakens it.

In other words, armature reaction is directly demagnetizing. Hence at zero P.f. lagging, the armature reaction weakens the main flux. This causes a reduction in the generated e.m.f.



Demagnetizing effect of armature reaction **When**

load Power Factor is Zero leading:

When a pure capacitive load (zero P.f. leading) is connected across the terminals of the alternator, the current in armature windings will lead the induced e.m.f. by 90° . The effect of

armature reaction will be the reverse that for pure inductive load. Thus armature flux now aids the main flux and the generated e.m.f. is increased.

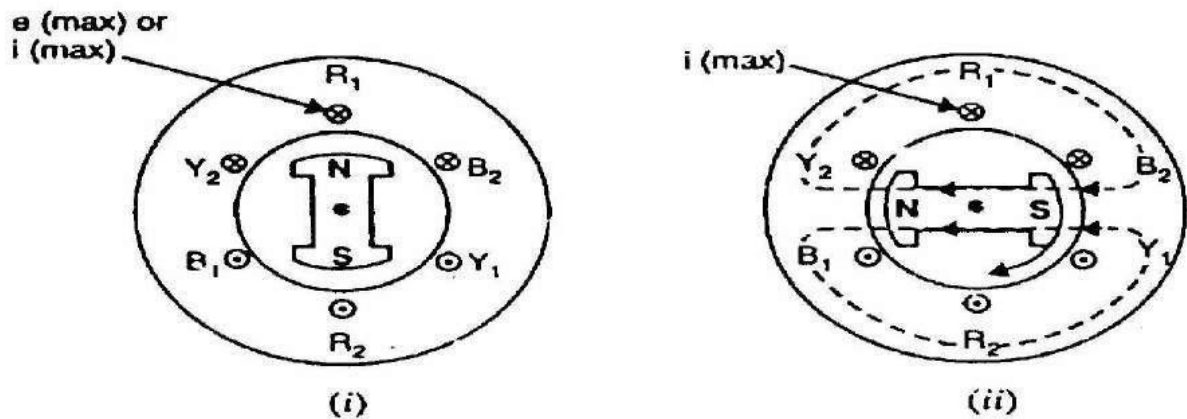
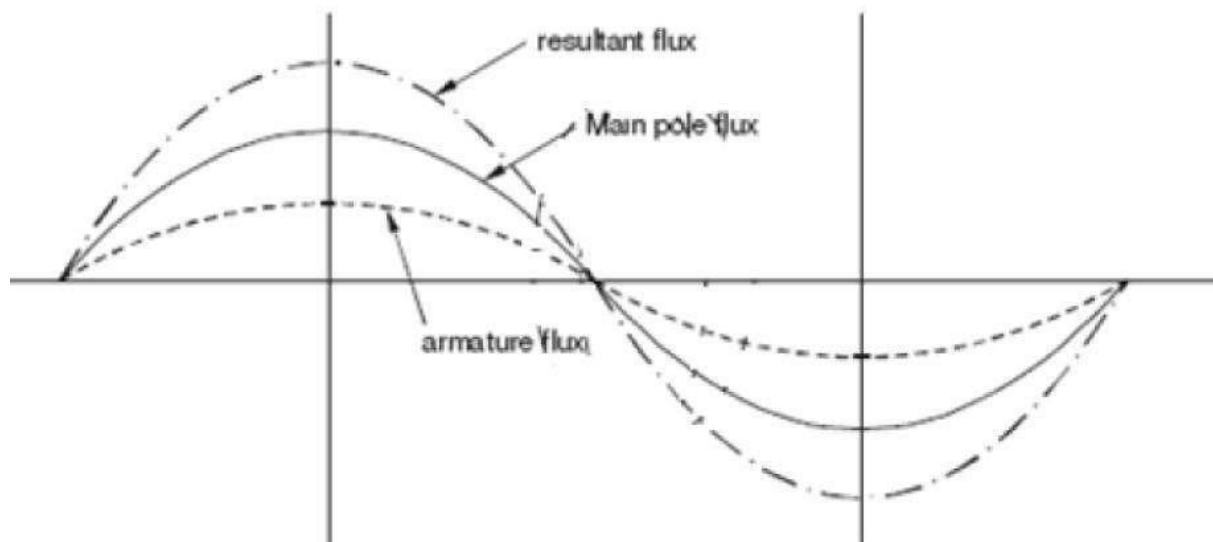

Fig:1(c)

When alternator supplying resistive load, e.m.f. as well as current in phase R_1R_2 is maximum in the position shown in fig:1(c)(i). When the alternator is supplying a pure capacitive load, the maximum current in R_1R_2 will occur 90° electrical before the occurrence of maximum induced e.m.f. Therefore, maximum current in phase R_1R_2 will occur if the position of the rotor remains 90° behind as compared to its position under resistive load which is shown in fig:1(c)(ii).

It is clear that armature flux is now in the same direction as the field flux and, therefore, strengthens it. This causes an increase in the generated voltage. Hence at zero P.f. leading, the armature reaction strengthens the main flux.



Magnetizing effect of armature reaction

For intermediate values of P.f, the effect of armature reaction is partly distorting and partly weakening for inductive loads. For capacitive loads, the effect of armature reaction is partly distorting and partly strengthening. In practice, loads are generally inductive load.

Alternator on Load:

When the load on the alternator is increased (i.e., armature current I_a is increased), the field excitation and speed being kept constant, the terminal voltage V (phase value) of the alternator decreases. This is due to

- i. Voltage drop $I_a R_a$ where R_a is the armature resistance per phase.
- ii. Voltage drop $I_a X_L$ where X_L is the armature leakage reactance per phase.
- iii. Voltage drop because of armature reaction.

i. Armature Resistance (Ra)

Since the armature or stator winding has some resistance, there will be an $I_a R_a$ drop when current (I_a) flows through it. The armature resistance per phase is generally small so that $I_a R_a$ drop is negligible for all practical purposes.

ii. Armature Leakage Reactance (XL)

When current flows through the armature winding, flux is set up and a part of it does not cross the air-gap and links the coil sides. This leakage flux alternates with current and gives the winding self-inductance. This is called armature leakage reactance. Therefore, there will be $I_a X_L$ drop which is also effective in reducing the terminal voltage.

iii. Armature reaction

The load is generally inductive and the effect of armature reaction is to reduce the generated voltage. The armature reaction effect is accounted for by assuming the presence of a fictitious reactance X_{AR} in the armature winding. The quantity X_{AR} is called reactance of armature reaction. The value of $I_a X_{AR}$ represents the voltage drop due to armature reaction.

Equivalent Circuit:

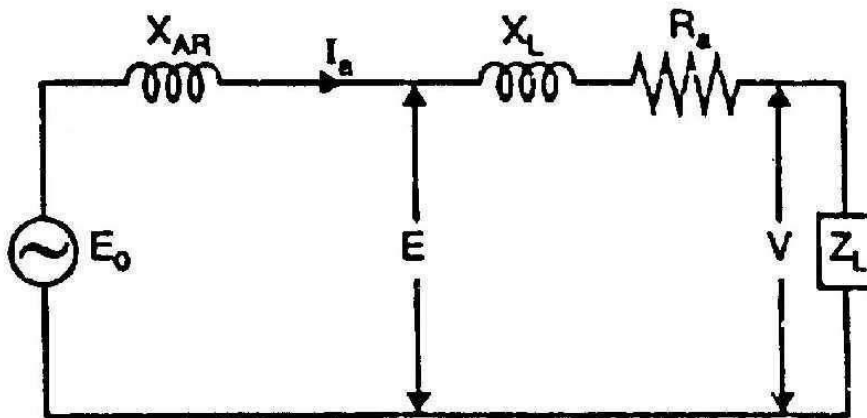

E_0 = No-load e.m.f.

E = Load induced e.m.f. It is the induced e.m.f. after allowing for armature reaction. It is equal to phasor difference of E_0 and $I_a X_{AR}$.

V = Terminal voltage. It is less than E by voltage drops in X_L and R_a .

$$E = V + I_a (R_a + j X_L)$$

and $E_0 = E + I_a (j X_{AR})$

Synchronous Reactance (Xs) and Synchronous Impedance:

The sum of armature leakage reactance (X_L) and reactance of armature reaction (X_{AR}) is called synchronous reactance X_s . All quantities are per phase. $X_s = X_L + X_{AR}$

The *synchronous reactance* is a fictitious reactance employed to account for the voltage effects in the armature circuit produced by the actual armature leakage reactance and the change in the air-gap flux caused by armature reaction.

The *synchronous impedance* is the fictitious impedance employed to account for the voltage effects in the armature circuit produced by the actual armature resistance, the actual armature leakage reactance and the change in the air-gap flux produced by armature reaction.

Synchronous impedance, $Z_s = R_a + j X_s$

$$E_0 \approx V \approx I_a Z_s \approx V \approx I_a (R_a + j X_s)$$

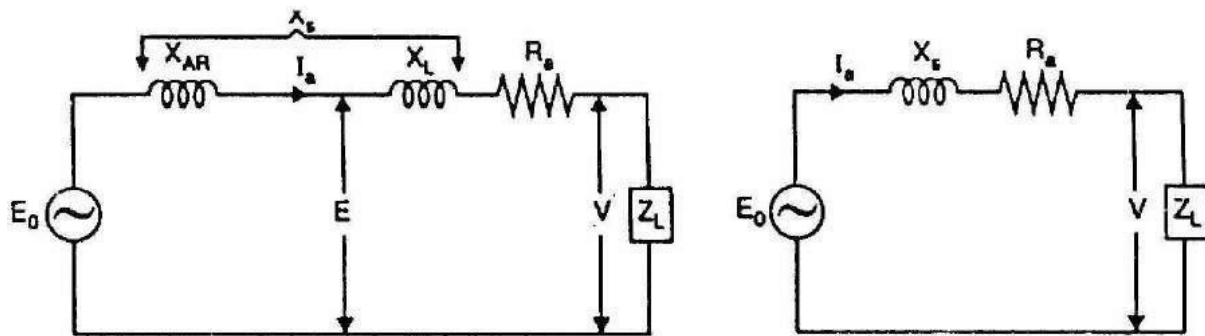

Phasor Diagram of a Loaded Alternator:

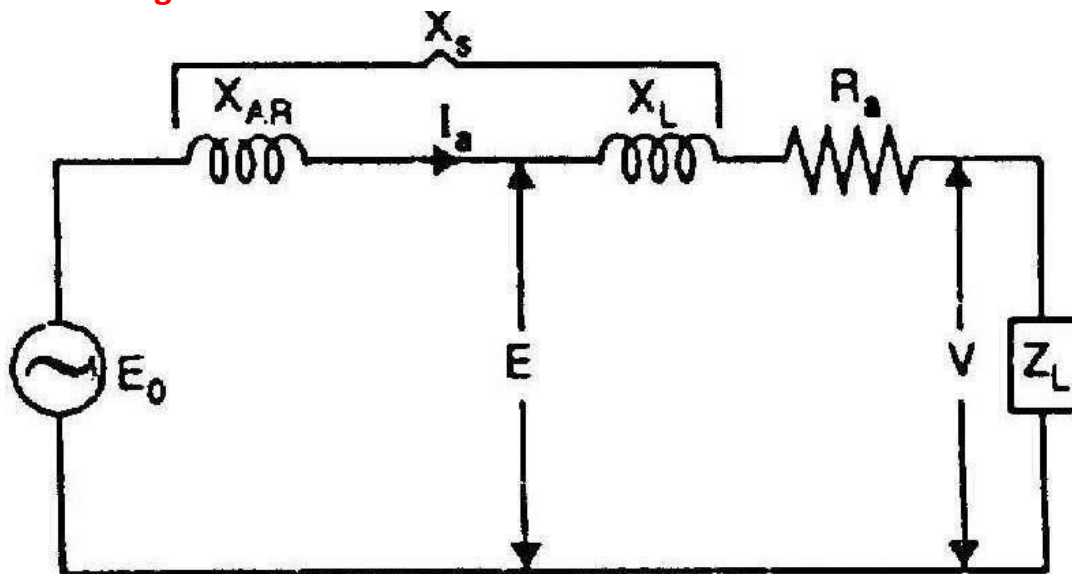

E_0 is the no-load voltage. It is the maximum voltage induced in the armature without giving any load.

E is the load voltage. It is the induced voltage after overcoming the armature reaction. E is vectorially less than the no-load voltage.

I_a is the armature current per phase

V is the terminal voltage. It is vectorially less than E by $I_a Z$ and also vectorially less than E_0 by $I_a Z_s$.

Φ is the cosine angle between terminal voltage and current. The impedances are given by

$$Z = R_a + j X_L$$

$$Z_s = R_a + j X_s$$

where X_L is the leakage reactance, X_{AR} is the armature reaction reactance and X_S is the synchronous reactance and Z_S is the synchronous impedance.

Unity power factor load:

The armature current I_a is in phase with the terminal voltage V . The phasor sum of V and drops $I_a R_a$ and $I_a X_L$ gives the load induced voltage E . It is the induced e.m.f. after allowing for armature reaction. The phasor sum of E and $I_a X_{AR}$ gives the no-load e.m.f. E_0 .

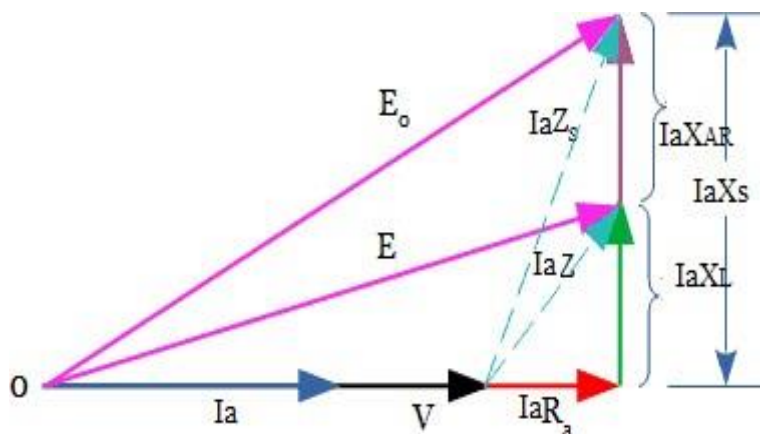

$$E_0 = \sqrt{(V + I_a R_a)^2 + (I_a X_S)^2}$$

Lagging power factor load:

The armature current I_a lags the terminal voltage V by p.f. angle Φ . The phasor sum of V and drops $I_a R_a$ and $I_a X_L$ gives the load induced voltage E . It is the induced e.m.f. after allowing for armature reaction. The phasor sum of E and $I_a X_{AR}$ gives the no-load e.m.f. E_0 .

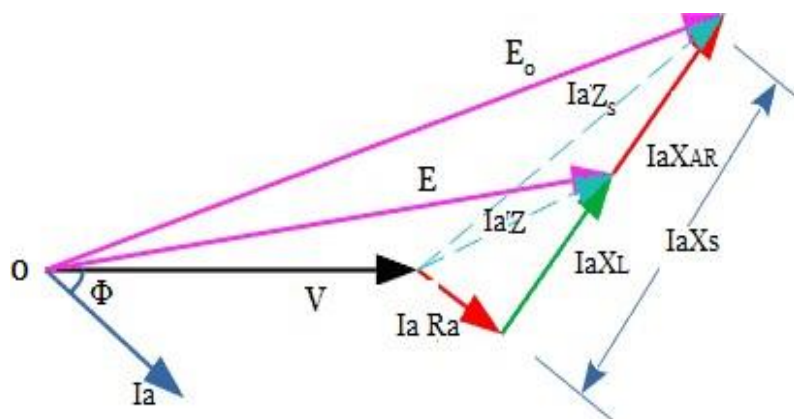

$$E_0 = \sqrt{(V \cos \phi + I_a R_a)^2 + (V \sin \phi + I_a X_S)^2}$$

Leading power factor load:

The armature current I_a leads the terminal voltage V by p.f. angle Φ . The phasor sum of V and drops $I_a R_a$ and $I_a X_L$ gives the load induced voltage E . It is the induced e.m.f. after allowing for armature reaction. The phasor sum of E and $I_a X_{AR}$ gives the no-load e.m.f. E_0 .

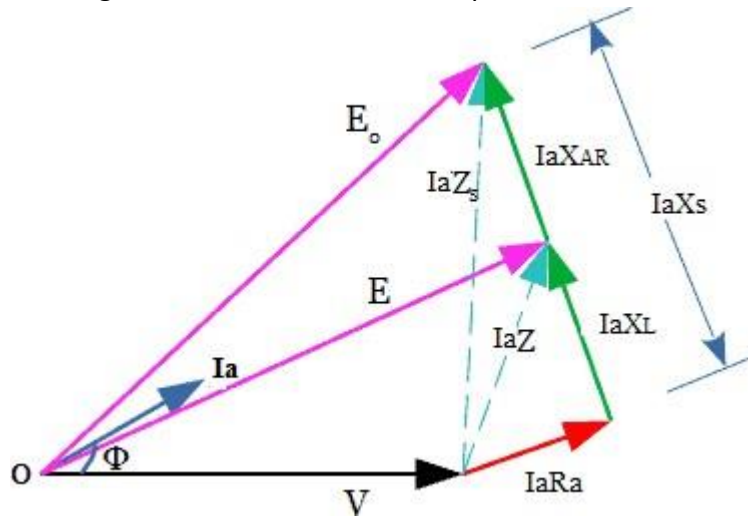

$$E_0 = \sqrt{(V \cos \phi + I_a R_a)^2 + (V \sin \phi - I_a X_s)^2}$$

Testing of Alternator:

The following tests are performed on an alternator to know its performance.

- D.C resistance test
- Open circuit test
- Short circuit test

a) D.C resistance test:

The armature resistance R_a per phase is determined by using direct current and the voltmeter-ammeter method. This is the d.c. value. The effective armature resistance (a.c. resistance) is greater than this value due to skin effect. It is 1.5 times the d.c. value ($R_{ac} = 1.5R_{dc}$).

b) Open circuit test:

The alternator is run on no-load at the rated synchronous speed and terminals are kept open. The field current I_f is gradually increased from zero (by adjusting field rheostat) until open-circuit voltage E_0 (phase value) is about 50% greater than the rated phase voltage. A graph is drawn between open-circuit voltage values and the corresponding values of field current I_f . The characteristic curve so obtained is called *open-circuit characteristic* (O.C.C).

This *open-circuit characteristic* (O.C.C) takes the shape of the magnetization curve for a d.c. machine. The extension of the linear portion of an O.C.C is called the *air-gap line* of the characteristic.

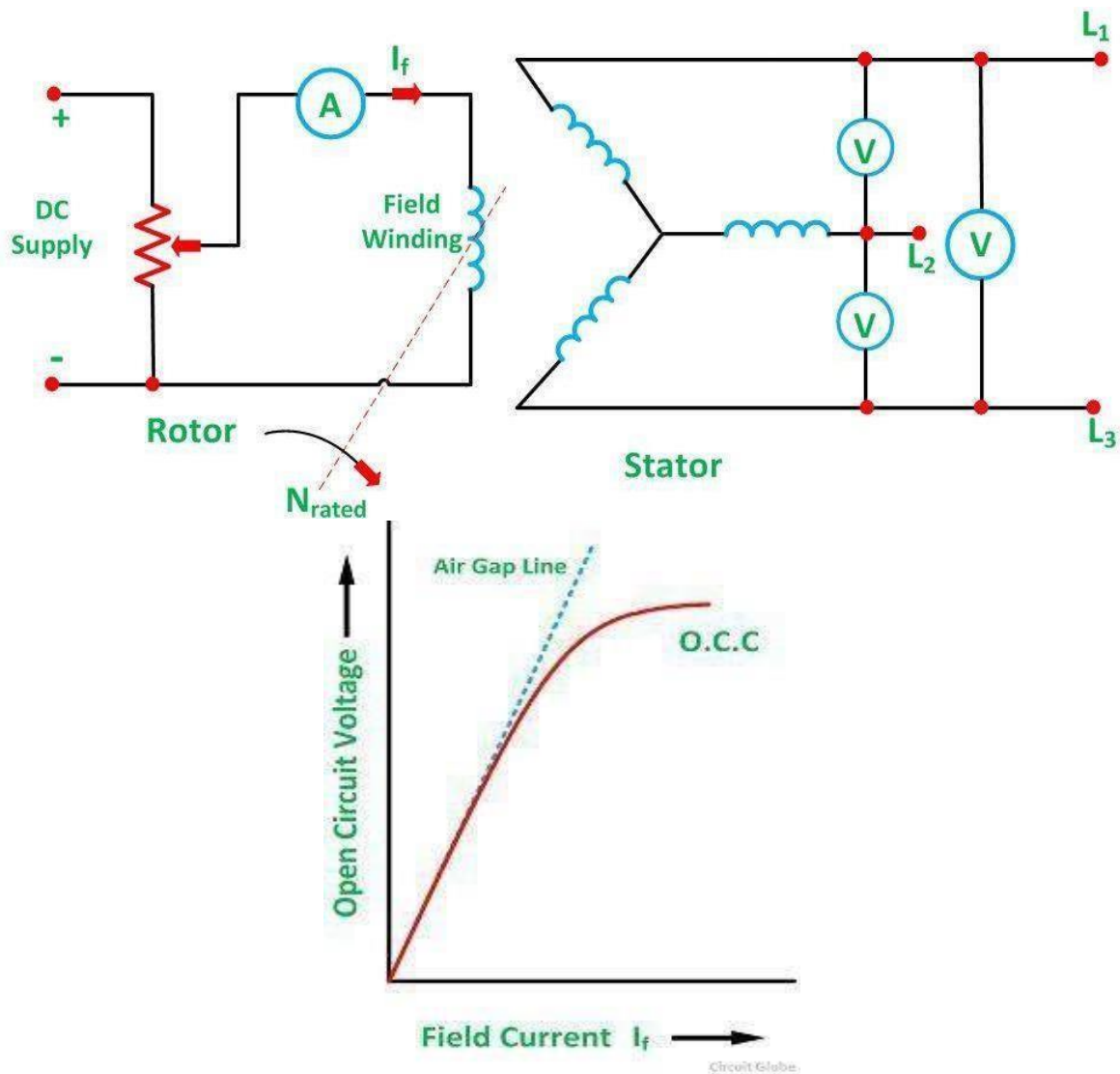

Fig: O.C.C of an Alternator

c) Short circuit test:

In a short-circuit test, the alternator is run at rated speed and the armature terminals are short-circuited through identical ammeters. The field current I_f is gradually increased from zero until the short-circuit armature current I_{sc} is about twice the rated current. The graph between short-circuit armature current and field current gives the short-circuit characteristic. This characteristic is a straight line.

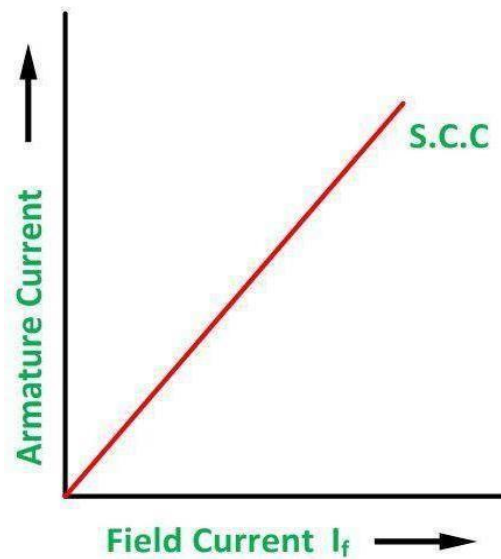
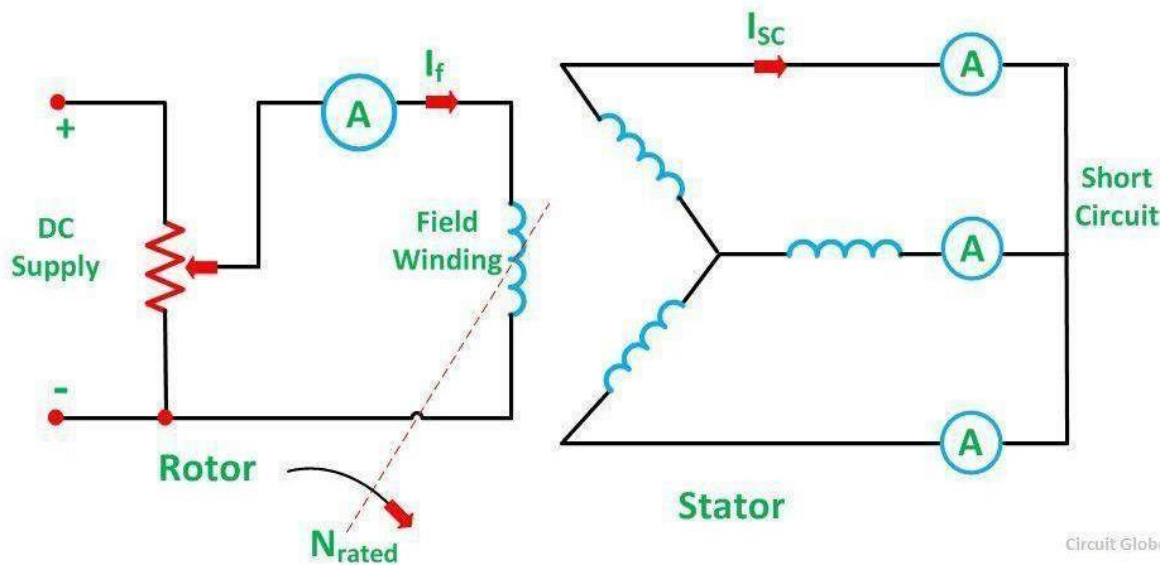

Fig: S.C.C of an alternator

Short-Circuit Ratio:

The short-circuit ratio is defined as the ratio of the field current required to produce rated volts on open circuit to field current required to circulate full-load current with the armature short-circuited.

$$\text{Short-circuit ratio (S.C.R)} = \frac{I_{foc}}{I_{fsc}}$$

Voltage Regulation of Alternator:

The voltage regulation of an alternator is defined as the change in terminal voltage from no-load to full-load divided by the full-load voltage when the speed and field current remaining constant.

$$\% \text{ Voltage Regulation} = \frac{\text{No load Voltage} - \text{Full load Voltage}}{\text{Full load Voltage}} \times 100$$

$$= \frac{E_0 - V}{V} \times 100$$

Where E_0 = No load voltage per phase

V = Terminal voltage per phase

The factors affecting the voltage regulation of an alternator are:

- i. $I_a R_a$ drop in armature winding
- ii. $I_a X_L$ drop in armature winding
- iii. Voltage change due to armature reaction

The change in terminal voltage due to armature reaction depends upon the armature current as well as power-factor of the load. For leading load P.f., the no-load voltage is less than the full-load voltage. Hence voltage regulation is negative in this case.

Determination of Voltage Regulation:

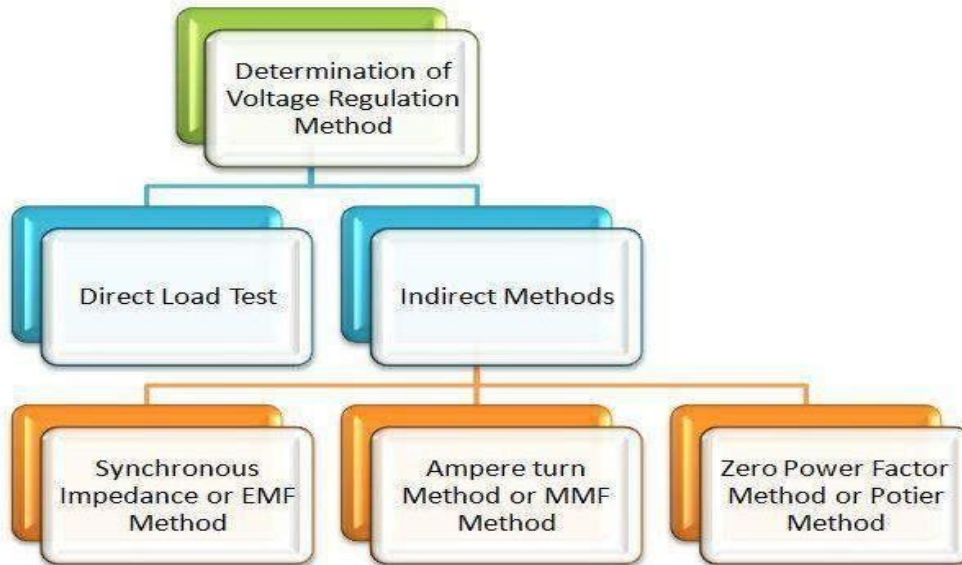

Direct Load Test:

The alternator runs at synchronous speed, and its terminal voltage is adjusted to its rated value V . The load is varied until the Ammeter and Wattmeter indicate the rated values at the given power factor. The load is removed, and the speed and the field excitation are kept constant. The value of the open circuit or no load voltage (E_0) is recorded.

$$\% \text{ Voltage Regulation} = \frac{E_0 - V}{V} \times 100$$

The method of direct loading is suitable only for small alternators of the power rating less than 5 kVA.

Indirect Methods:

For large alternators, there are three indirect methods of determining the voltage regulation of an alternator. These methods require only a small amount of power as compared to the power required for direct loading method. These methods are:

1. Synchronous impedance or E.M.F. method
2. Ampere-turn or M.M.F. method

3. Zero power factor method or Potier method

Synchronous impedance or E.M.F. method:

In this method of finding the voltage regulation of an alternator, we find the synchronous impedance Z_s (and hence synchronous reactance X_s) of the alternator from the O.C.C. and S.S.C. For this reason, it is called synchronous impedance method.

The method involves the following steps:

(i) Plot the O.C.C. and S.S.C. on the same field current base.

(ii) **Determination of synchronous impedance Z_s :**

As the terminals of the stator are short circuited in SC test, the short circuit current is circulated against the impedance of the stator called the synchronous impedance. This impedance can be estimated from the O.C and S.C characteristics.

The ratio of open circuit voltage to the short circuit current at a particular field current, or at a field current responsible for circulating the rated current is called the synchronous impedance.

$$\text{Synchronous impedance } Z_s = \frac{\text{Open circuit voltage per phase}}{\text{Short circuit current per phase for same } I_f}$$

$$Z_s = \frac{V_{oc}}{I_{sc}} \text{ for same } I_f$$

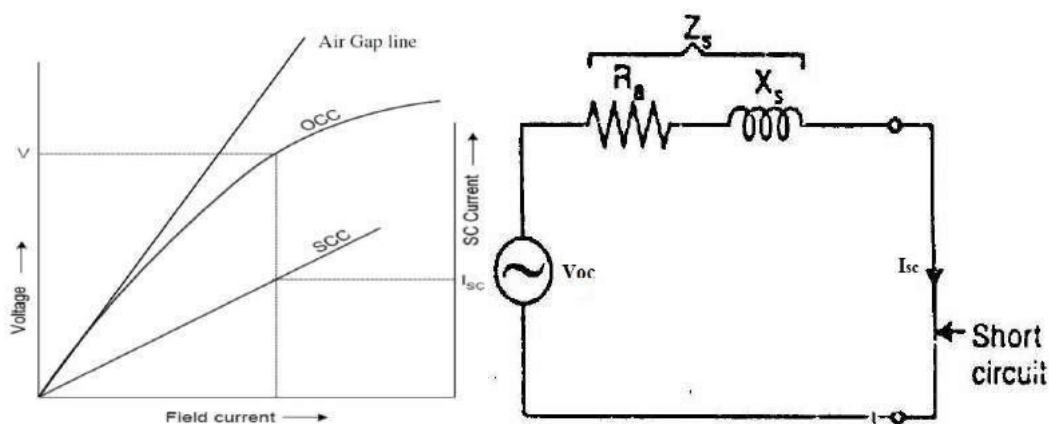

(iii) Synchronous Reactance

$$X_s = \sqrt{Z_s^2 - R_a^2}$$

(iv) After knowing R_a and X_s , the phasor diagram can be drawn for any load and any p.f. The phasor sum of terminal voltage V , $I_a R_a$ and $I_a X_s$ gives the no-load e.m.f. E_0 .

$$\% \text{ Voltage Regulation} = \frac{E_0 - V}{V} \times 100$$

Drawback:

This method is easy but it gives approximate results. The combined effect of X_L (armature leakage reactance) and X_{AR} (reactance of armature reaction) is measured on short-circuit. Since the current in this condition is almost lagging 90° , the armature reaction will provide its demagnetizing effect. This method gives a value higher than the value obtained from an actual load test. For this reason, it is called *pessimistic* method.

Parallel Operation of Alternators:

The method of connecting an incoming alternator safely to the live busbar is known as synchronizing. Certain conditions must be fulfilled before this can be effected. The incoming machine must have its voltage and frequency equal to that of the bus bars and, should be in same phase with bus bar voltage. The instruments or apparatus for determining when these conditions are fulfilled are called synchro scopes. Synchronizing can be done with the help of (i) dark & bright lamp method by (ii) using synchro scope

Advantages of Parallel operation of Alternators:

- a) **Continuity of service:** The continuity of service is one of the important requirements of any electrical apparatus. If one alternator fails, the continuity of supply can be maintained through the other healthy units. This will ensure uninterrupted supply to the consumers.
- b) **Efficiency:** The load on the power system varies during the whole day; being minimum during late night hours. Since alternators operate most efficiently when delivering full-load, units can be added or put off depending upon the load requirement. This permits the efficient operation of the power system.
- c) **Maintenance and repair:** It is often desirable to carry out routine maintenance and repair of one or more units. For this purpose, the desired unit/units can be shut down and the continuity of supply is maintained through the other units.
- d) **Load growth:** The load demand is increasing due to the increasing use of electrical energy. The load growth can be met by adding more units without disturbing the original installation.

Conditions for Paralleling Alternator with Infinite Busbars:

For proper synchronization of alternators, the following four conditions must be satisfied

1. The terminal voltage (r.m.s. value) of the incoming alternator must be the same as bus bars voltage.
2. The frequency of the generated voltage of the incoming alternator must be equal to the bus bars frequency.
3. The phase of the incoming alternator voltage must be identical with the phase of the bus bars voltage. In other words, the two voltages must be in phase with each other.
4. The phase sequence of the voltage of the incoming alternator should be the same as that of the bus bars.

The magnitude of the voltage of the incoming alternator can be adjusted by changing its field excitation. The frequency of the incoming alternator can be changed by adjusting the speed of the prime mover driving the alternator.

Methods of Synchronization:

The method of connecting an incoming alternator safely to the live bus bars is called synchronizing. The equality of voltage between the incoming alternator and the bus bars can be easily checked by a voltmeter. The phase sequence of the alternator and the bus bars can

be checked by a phase sequence indicator. Differences in frequency and phase of the voltages of the incoming alternator and bus bars can be checked by one of the following two methods:

- i. By Dark & Bright Lamp method
- ii. By Synchroscope

i. By Dark & Bright Lamp method:

In three phase alternators, it is necessary to synchronize one phase only, the other two phases will be then synchronized automatically. However, first it is necessary that the incoming alternator is correctly 'phased out' i.e. the phases are connected in the proper order of R, Y & B not R, B, Y etc.

In this method of synchronizing, three lamps L1, L2 and L3 are connected as shown in Fig. below. The lamp L1 is straight connected between the corresponding phases (R1 and R2) and the other two are cross-connected between the other two phases. Thus lamp L2 is connected between Y1 and B2 and lamp L3 between B1 and Y2. When the frequency and phase of the voltage of the incoming alternator is the same as that of the bus bars, the straight connected lamps L1 will be dark while cross-connected lamps L2 and L3 will be equally bright. At this instant, the synchronization is perfect and the switch of the incoming alternator can be closed to connect it to the bus bars.

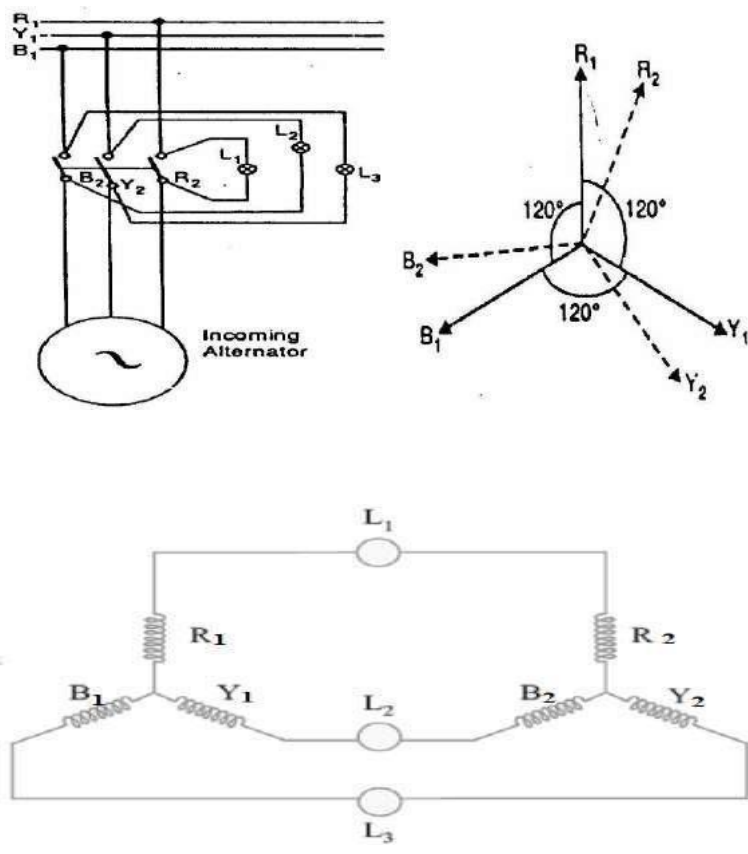

Phasors R1, Y1 and B1 represent the bus bars voltages and phasors R2, Y2 and B2 represent the voltages of the incoming alternator. At the instant when R1 is in phase with R2, voltage across lamp L1 is zero and voltages across lamps L2 and L3 are equal. Therefore, the lamp L1 is dark while lamps L2 and L3 will be equally bright. At this instant, the switch of the incoming alternator can be closed. Thus incoming alternator gets connected in parallel with the bus bars.

ii. By Synchroscope:

A synchro scope is an instrument that indicates by means of a revolving pointer the phase difference and frequency difference between the voltages of the incoming alternator and the bus bars.

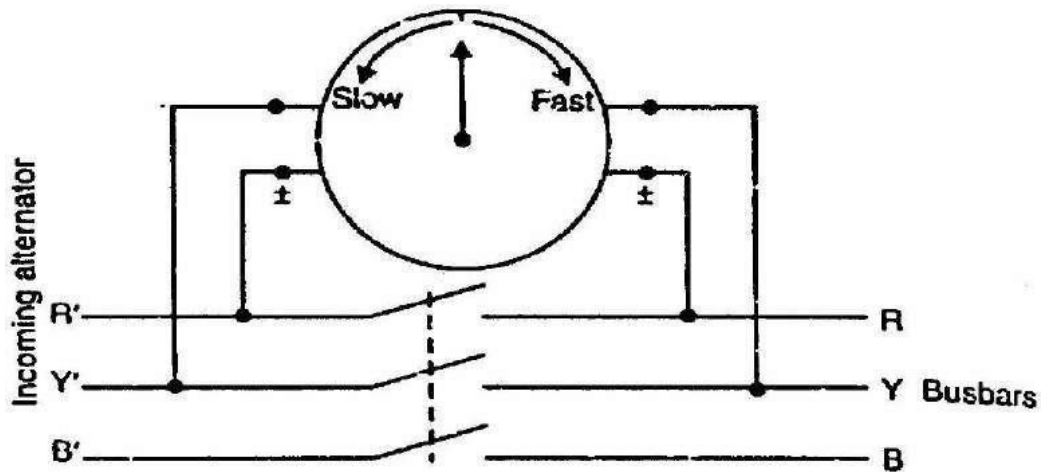

It is essentially a small motor, the field being supplied from the bus bars through a potential transformer and the rotor from the incoming alternator. A pointer is attached to the rotor. When the incoming alternator is running fast (i.e., frequency of the incoming alternator is higher than that of the bus bars), the rotor and hence the pointer moves in the clockwise direction. When the incoming alternator is running slow (i.e., frequency of the incoming alternator is lower than that of the bus bars), the pointer moves in anti-clockwise direction. When the frequency of the incoming alternator is equal to that of the bus bars, no torque acts on the rotor and the pointer points vertically upwards ("12 O' clock"). It indicates the correct instant for connecting the incoming alternator to the bus bars. The synchroscope method is superior to the lamp method because it not only gives a positive indication of the time to close the switch but also indicates the adjustment to be made should there be a difference between the frequencies of the incoming alternator and the bus bars.

Sharing of Load Currents by Two Alternators in Parallel:

Consider two alternators with identical speed/load characteristics connected in Parallel.

Let

$E_{1,2}$ = induced e.m.f.s per phase

$Z_{1,2}$ = synchronous impedances per phase

Z = load impedance per phase

$I_{1,2}$ = currents supplied by two machines

V = common terminal voltage per phase

$$V = E_1 - I_1 Z_1 = E_2 - I_2 Z_2$$

$$I = I_1 + I_2 = \frac{E_1 - V}{Z_1} + \frac{E_2 - V}{Z_2}$$

$$I_1 = \frac{E_2 - V}{Z_1} ; \quad I_2 = \frac{E_1 - V}{Z_2}$$

$$V = (I_1 + I_2)Z = IZ$$

Circulating current on no-load is

$$I_c = \frac{E_1 - E_2}{Z_1 + Z_2}$$

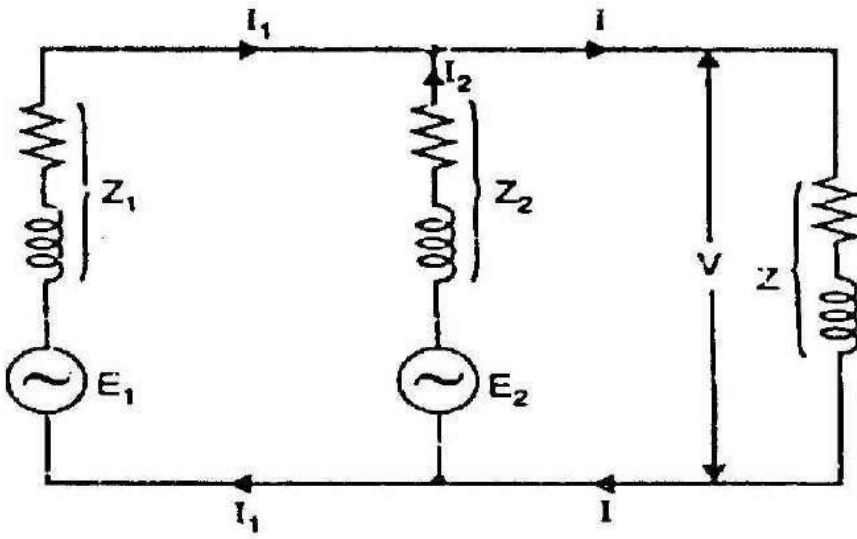

CHAPTER-2 SYNCHRONOUS

MOTOR

Constructional feature of Synchronous Motor:

A synchronous motor is a machine that operates at synchronous speed and converts electrical energy into mechanical energy. As the name implies, a synchronous motor runs at synchronous speed ($N_s = 120f/P$) i.e., in synchronism with the revolving field produced by the 3-phase supply.

Like an alternator, a synchronous motor has the following **two** parts:

- (i) **a stator** which houses 3-phase armature winding in the slots of the stator core and receives power from a 3-phase supply.
- (ii) **a rotor** that has a set of salient poles excited by direct current to form alternate N and S poles. The exciting coils are connected in series to two slip rings and direct current is fed into the winding from an external exciter mounted on the rotor shaft. The stator is wound for the same number of poles as the rotor poles.

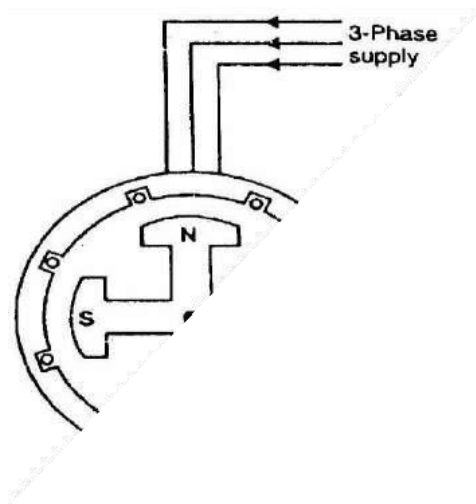

Some salient features of a synchronous motor are:

- (i) A synchronous motor runs at synchronous speed. Its speed is constant (synchronous speed) at all loads. The only way to change its speed is to alter the supply frequency ($N_s = 120 f/P$).
- (ii) The characteristic of a synchronous motor is that it can be made to operate over a wide range of power factors (lagging, unity or leading) by adjustment of its field excitation. Therefore, a synchronous motor can be made to carry the mechanical load at constant speed and at the same time improve the power factor of the system.
- (iii) Synchronous motors are generally of the salient pole type.

(iv) A synchronous motor is not self-starting and an auxiliary means has to be used for starting it.

Principles of operation:

Consider a 3-phase synchronous motor having two rotor poles N_R and S_R . Then the stator will also be wound for two poles N_S and S_S . The armature winding of a 3-phase synchronous motor is connected to a suitable balanced 3-phase source and the field winding to a D.C source of rated voltage. When a 3 phase armature winding is fed by a 3 phase supply then a magnetic field of constant magnitude but rotating synchronous speed is produced in the stator. Consider two stator pole N_S and S_S rotating at synchronous speed in clockwise direction. The direct current sets up a two-pole field which is stationary. Thus, there exists a pair of revolving armature poles (i.e., N_S - S_S) and a pair of stationary rotor poles (i.e., N_R - S_R).

Suppose at any instant, the stator poles are at positions A and B as shown in Fig.(i). It is clear that poles N_S and N_R as well as the poles S_S and S_R will repel each other. Therefore, the rotor tends to move in the anticlockwise direction. After a period of half-cycle (or $1/2f = 1/100$ second), the polarities of the stator poles are reversed but the polarities of the rotor poles remain the same as shown in Fig.(ii). Now S_S attracts N_R and N_S attracts S_R . Therefore, the rotor tends to move in the clockwise direction. Since the stator poles change their polarities rapidly, they tend to pull the rotor first in one direction and then after a period of half-cycle in the other. Due to high inertia of the rotor, the motor fails to start.

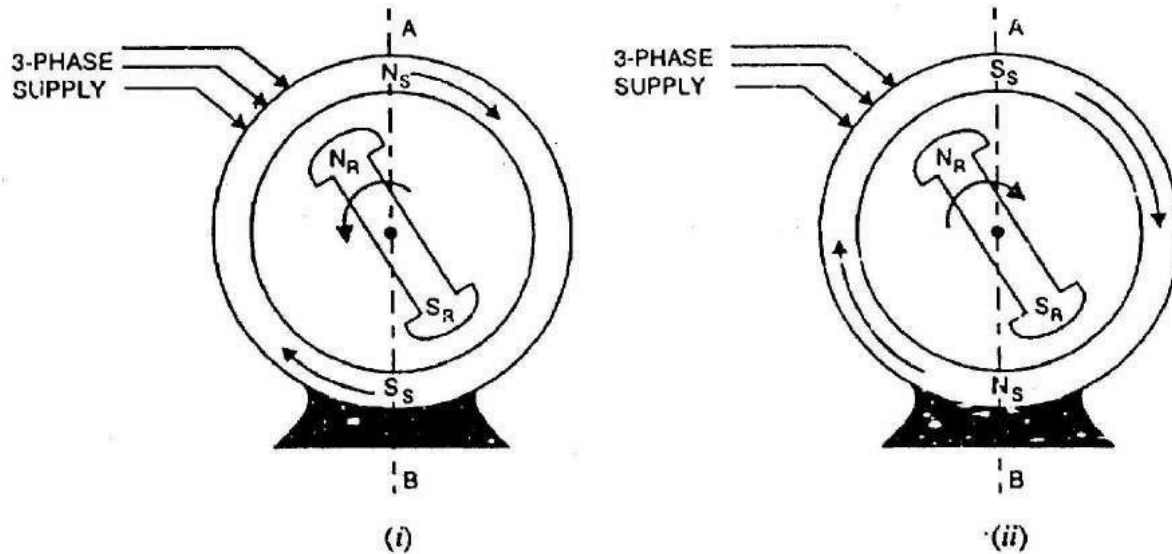

Hence, a synchronous motor has no self-starting torque i.e., a synchronous motor cannot start by itself.

Motor on Load:

In d.c. motors and induction motors, an addition of load causes the motor speed to decrease. The decrease in speed reduces the counter e.m.f. enough so that additional current is drawn from the source to carry the increased load at a reduced speed. This action cannot take place in a synchronous motor because it runs at a constant speed (i.e., synchronous speed) at all loads. The rotor poles fall slightly behind the stator poles while continuing to run at synchronous speed. The angular displacement between stator and rotor poles (called torque angle δ) causes the phase of back e.m.f. E_b to change w.r.t. supply voltage V . This increases the net e.m.f. E_r in the stator winding. Consequently, stator current $I_a (= E_r/Z_s)$ increases to carry the load.

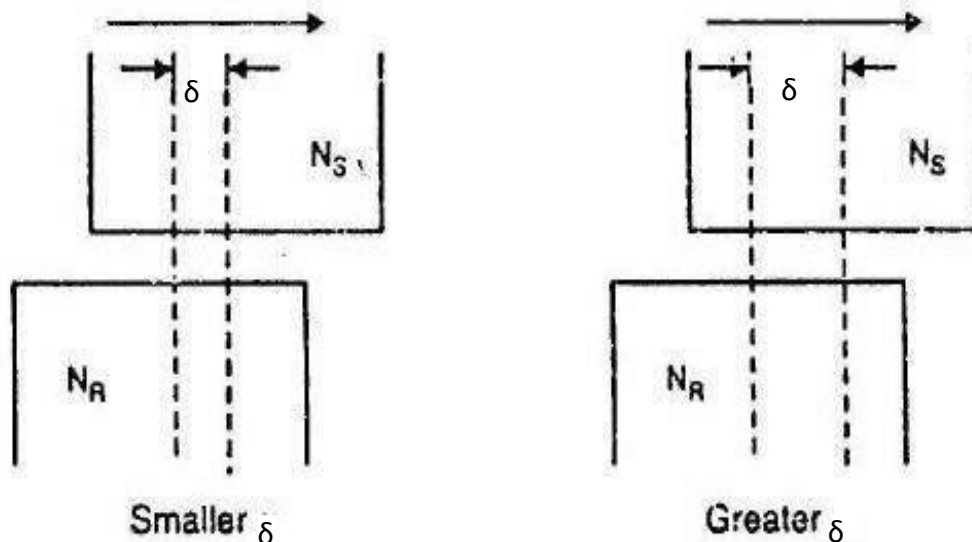

The following points may be noted in synchronous motor operation:

- i. A synchronous motor runs at synchronous speed at all loads. It meets the increased load not by a decrease in speed but by the relative shift between stator and rotor poles i.e., by the adjustment of torque angle δ .
- ii. If the load on the motor increases, the torque angle δ also increases (i.e., rotor poles lag behind the stator poles by a greater angle) but the motor continues to run at synchronous speed. The increase in torque angle δ causes a greater phase shift of back e.m.f. E_b w.r.t. supply voltage V . This increases the net voltage E_r in the stator winding. Consequently, armature current $I_a (= E_r/Z_s)$ increases to meet the load demand.
- iii. If the load on the motor decreases, the torque angle δ also decreases. This causes a smaller phase shift of E_b w.r.t. V . Consequently, the net voltage E_r in the stator winding decreases and so does the armature current $I_a (= E_r/Z_s)$.

Load angle (or Torque angle):

The load angle is defined as the angle between Induced EMF and terminal voltage. For a synchronous generator, rotor field and stator field are rotated at synchronous speed. These two fields are not fully aligned. The stator field lags the rotor field. This lagging expressed in angle is called **load angle**. This angle is represented by δ .

The power developed by the generator is directly proportional to sine of this angle. This angle plays an important role for the stability of the generator. If the angle goes beyond 90° , the generator becomes unstable. This may happen when sudden change of large load occurs or fault sustains longer time.

For the case of synchronous motor, the angle is called **torque angle** and the **rotor field lags the stator field** in this case.

Equivalent Circuit:

The synchronous motor is connected to two electrical systems; a d.c. source at the rotor terminals and an a.c. system at the stator terminals.

1. Under normal conditions of synchronous motor operation, no voltage is induced in the rotor by the stator field because the rotor winding is rotating at the same speed as the stator field. Only the impressed direct current is present in the rotor winding and ohmic resistance of this winding is the only opposition to it as shown in Fig.(i).
2. In the stator winding, two effects are to be considered, the effect of stator field on the stator winding and the effect of the rotor field cutting the stator conductors at synchronous speed.

- i. The effect of stator field on the stator (or armature) conductors is accounted for by including an inductive reactance in the armature winding. This is called synchronous reactance X_s . A resistance R_a must be considered to be in series with this reactance to account for the copper losses in the stator or armature winding. This resistance combines with synchronous reactance and gives the synchronous impedance of the machine.
- ii. The second effect is that a voltage is generated in the stator winding by the synchronously-revolving field of the rotor as shown in Fig.(ii). This generated e.m.f. E_b is known as back e.m.f. and opposes the stator voltage V . The magnitude of E_b depends upon rotor speed and rotor flux Φ per pole. Since rotor speed is constant; the value of E_b depends upon the rotor flux per pole i.e. exciting rotor current I_f .

For synchronous motor

$$V = E_b + I_a Z_s$$

$$V = E_b + I_a(R_a + jX_s)$$

$$E_b = V - I_a R_a - jI_a X_s$$

$$Z_s = \sqrt{R_a^2 + X_s^2}$$

A synchronous motor is said to be normally excited if the field excitation is such that $E_b = V$. If the field excitation is such that $E_b < V$, the motor is said to be under-excited. The motor is said to be over-excited if the field excitation is such that $E_b > V$.

For both normal and under excitation, the motor has lagging power factor. However, for over-excitation, the motor has leading power factor.

Phasor Diagram of a Cylindrical Rotor Synchronous Motor:

Unity power factor:

At unity power factor, the current I , drawn by the motor is in phase with supply voltage V .

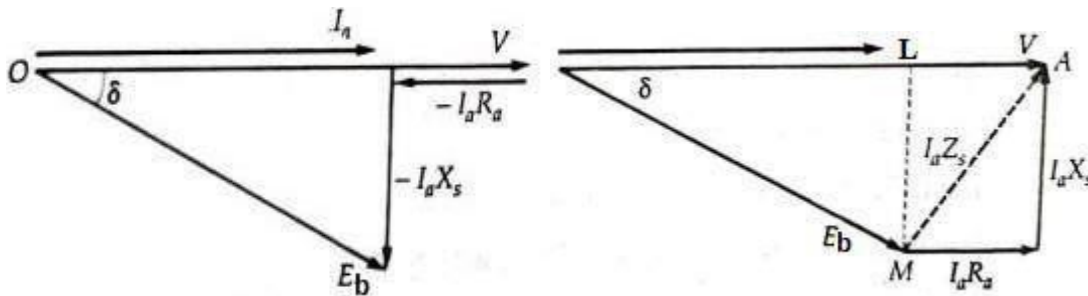

$$OM^2 = OL^2 + LM^2$$

$$E_b^2 = (V - I_a R_a)^2 + (I_a X_s)^2$$

Lagging power factor $\cos\Phi$:

Suppose that the synchronous motor is taking a lagging current from the supply. V is taken as reference phasor. For lagging power factor $\cos\Phi$, the direction of armature current I , lags behind V by an angle Φ .

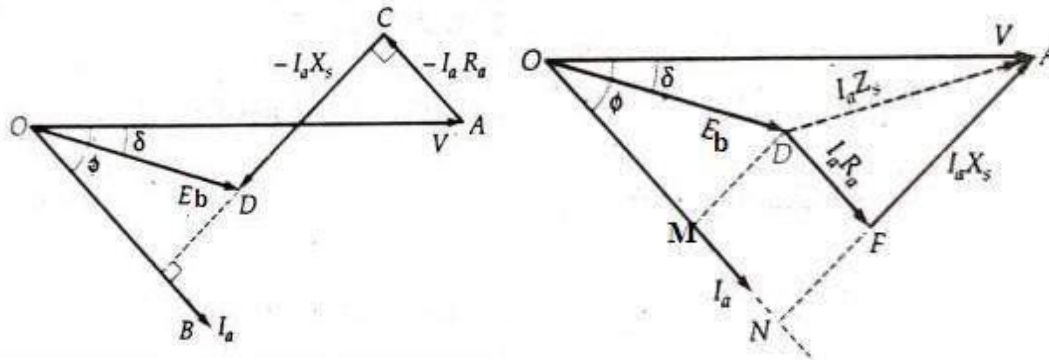

$$OD^2 = OM^2 + MD^2 = OM^2 + NF^2$$

$$= (ON - MN)^2 + (NA - FA)^2$$

$$E_b^2 = (V \cos \phi - I_a R_a)^2 + (V \sin \phi - I_a X_s)^2$$

Leading power factor $\cos\Phi$:

When the motor is operating at leading power factor $\cos\Phi$, the current I , drawn by the motor leads the supply voltage V by the phase angle Φ .

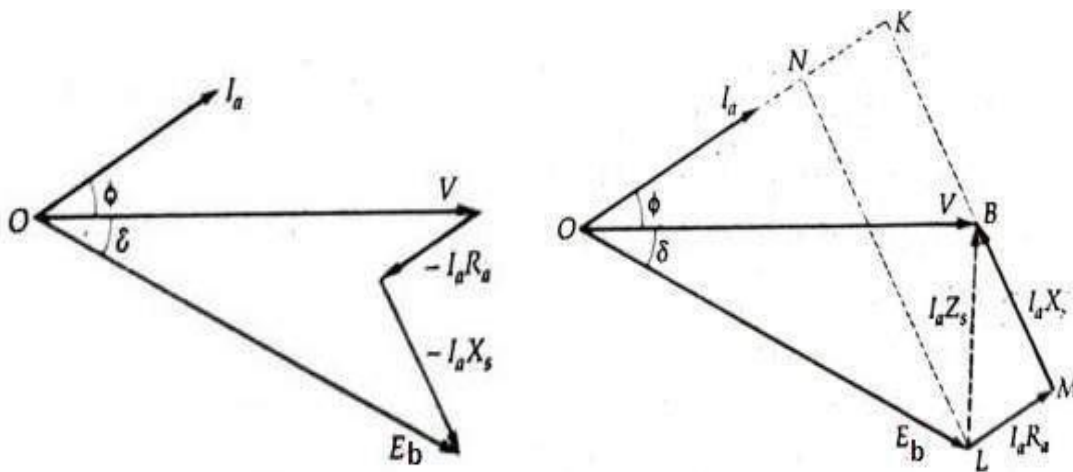

$$OL^2 = ON^2 + NL^2 = (OK - NK)^2 + (KB + BM)^2$$

$$E_b^2 = (V \cos \phi - I_a R_a)^2 + (V \sin \phi + I_a X_s)^2$$

Determination of E_b , by using complex algebra:

Let V be taken as reference phasor.

$$\therefore V = V \angle 0^\circ = V + j0$$

For lagging power factor $\cos \phi$

$$I_a = I_a \angle -\phi = I_a \cos \phi - j I_a \sin \phi$$

For unity power factor

$$I_a = I_a \angle 0^\circ = I_a + j0$$

For leading power factor

$$I_a = I_a \angle +\phi = I_a \cos \phi + j I_a \sin \phi$$

The synchronous impedance is given by

$$Z = R_a + jX_s$$

The Back emf is given by

$$E_b = V - I_a Z_s$$

For lagging power factor $\cos \phi$

$$\begin{aligned} E_b \angle \delta &= V \angle 0^\circ - (I_a \angle -\phi) (R_a + jX_s) \\ &= V + j0 - (I_a \cos \phi - j I_a \sin \phi) (R_a + jX_s) \\ &= (V - I_a R_a \cos \phi - I_a X_s \sin \phi) - j (I_a X_s \cos \phi - I_a R_a \sin \phi) \end{aligned}$$

$$E_b = \sqrt{(V - I_a R_a \cos \phi - I_a X_s \sin \phi)^2 + (I_a X_s \cos \phi - I_a R_a \sin \phi)^2}$$

$$\delta = \tan^{-1} \frac{I_a R_a \sin \phi - I_a X_s \cos \phi}{V - I_a R_a \cos \phi - I_a X_s \sin \phi}$$

Similarly, for leading power factor $\cos \phi$

$$E_b = \sqrt{(V - I_a R_a \cos \phi + I_a X_s \sin \phi)^2 + (I_a X_s \cos \phi + I_a R_a \sin \phi)^2}$$

$$\delta = -\tan^{-1} \left(\frac{I_a X_s \cos \phi + I_a R_a \sin \phi}{V - I_a R_a \cos \phi + I_a X_s \sin \phi} \right)$$

For unity power factor ($\cos \phi = 1$)

$$E_b = \sqrt{(V - I_a R_a)^2 + (I_a X_s)^2}$$

$$\delta = -\tan^{-1} \left(\frac{I_a X_s}{V - I_a R_a} \right)$$

Salient Pole Synchronous Machine:

A multipolar machine with cylindrical rotor has a uniform air-gap, because of which its reactance remains the same, irrespective of the spatial position of the rotor. However, a synchronous machine with salient or projecting poles has non-uniform air-gap due to which its reactance varies with the rotor position.

Consequently, a cylindrical rotor machine possesses one axis of symmetry (pole axis or direct axis) whereas salient-pole machine possesses two axes of geometric symmetry (i) field poles axis, called direct axis or d-axis and (ii) axis passing through the centre of the interpolar space, called the quadrature axis or q-axis.

The axis along the axis of the rotor is called direct (or d-) axis and the axis perpendicular to d-axis is called the quadrature (or q-) axis. Along the d-axis air gap is small and along the q axis air gap is large. The magnetic reluctance is low along the poles and high between the poles.

Two mmfs act on a salient-pole synchronous machine i.e. d-axis m.m.f. and q-axis m.m.f. The above facts form the basis of the two-reaction theory proposed by Blondel,

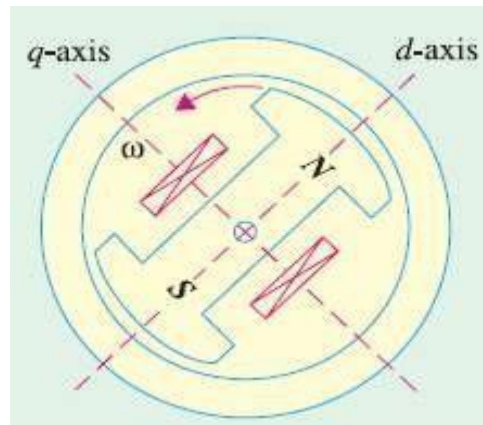

Two-Reaction Theory (Blondel Theory):

Two-reaction theory proposes to resolve the given armature mmfs (F_a) into two mutually perpendicular components, with one located along the axis of the rotor salient pole. It is known as the direct-axis (or d-axis) component (F_d). The other component is located perpendicular to the axis of the rotor salient pole. It is known as the quadrature-axis (or q-axis) component (F_q). The component F_d is either magnetizing or demagnetizing. The Component F_q , results in a cross-magnetising effect.

If ψ is the angle between the armature current I_a , and the excitation voltage E_f and F_a is the amplitude of the armature mmf, then

$$F_d = F_a \sin T \quad F_q = F_a \cos T$$

Phasor Diagram of a Salient-pole Synchronous Motor:

The equivalent circuit of a salient-pole synchronous Motor is shown in Fig: below. The component currents I_d and I_q provide component voltage drops jI_dX_d and jI_qX_q . The armature current I_a has been resolved into its rectangular components with respect to the axis for excitation voltage E_b . The angle T between E_b and I_a is known as the internal power factor angle. The vector for the armature resistance drop I_aR_a is drawn parallel to I_a . Vector for the drop I_dX_d is drawn perpendicular to I_d whereas that for I_qX_q is drawn perpendicular to I_q . The angle δ between E_b and V is called the torque angle. The voltage equation for a salient pole synchronous motor is

$$V = E_b + I_a R_a + j I_d X_d + j I_q X_q \quad [I_a = I_d + I_q]$$

If R_a is neglected then

$$V = E_b + j I_d X_d + j I_q X_q$$

Similarly, The voltage equation for a salient pole synchronous Generator is

$$E_0 = V + I_a R_a + j I_d X_d + j I_q X_q$$

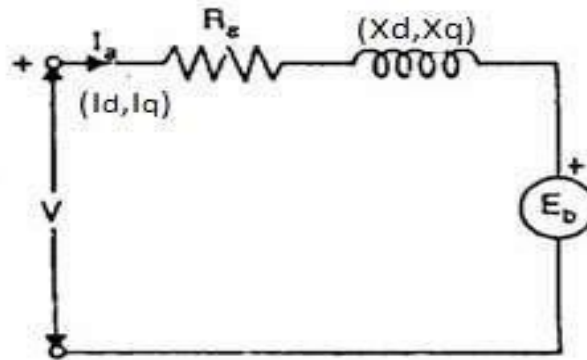

The voltage equation for a salient pole synchronous motor is

$$V = E_b + I_a R_a + j I_d X_d + j I_q X_q$$

a) Lagging power factor $\cos\Phi$

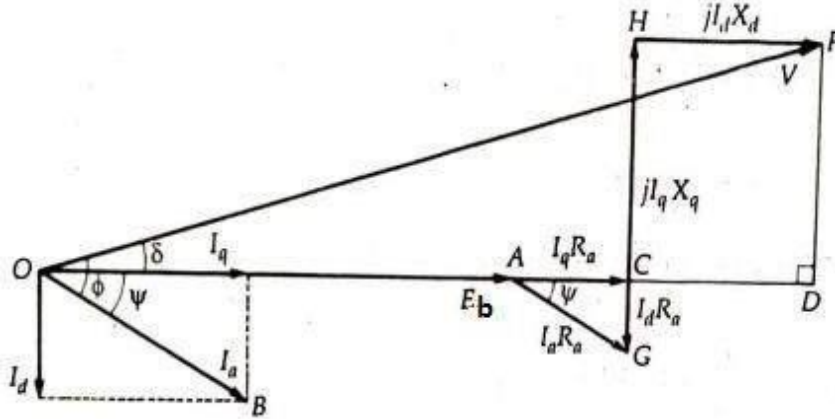

Fig: Phasor diagram of a salient-pole synchronous motor at lagging pf $\cos \phi$

Here $OA = E_b$, $AG = I_a R_a$, $GH = I_q X_q$, $HF = I_d X_d$, $OF = V$

$$OD = OA + AC + CD$$

$$V \cos \delta = E_b + I_q R_a + I_d X_d$$

$$GH = GC + CH$$

$$I_q X_q = I_d R_a + V \sin \delta$$

$$\psi = \phi - \delta$$

$$I_d = I_a \sin \psi = I_a \sin (\phi - \delta)$$

$$I_q = I_a \cos \psi = I_a \cos (\phi - \delta)$$

$$I_a X_q \cos (\phi - \delta) = I_a R_a \sin (\phi - \delta) + V \sin \delta$$

$$I_a X_q (\cos \phi \cos \delta + \sin \phi \sin \delta)$$

$$= I_a R_a (\sin \phi \cos \delta - \cos \phi \sin \delta) + V \sin \delta$$

$$(V - I_a R_a \cos \phi - I_a X_q \sin \phi) \sin \delta$$

$$= (I_a X_q \cos \phi - I_a R_a \sin \phi) \cos \delta$$

$$\therefore \tan \delta = \frac{I_a X_q \cos \phi - I_a R_a \sin \phi}{V - I_a X_q \sin \phi - I_a R_a \cos \phi}$$

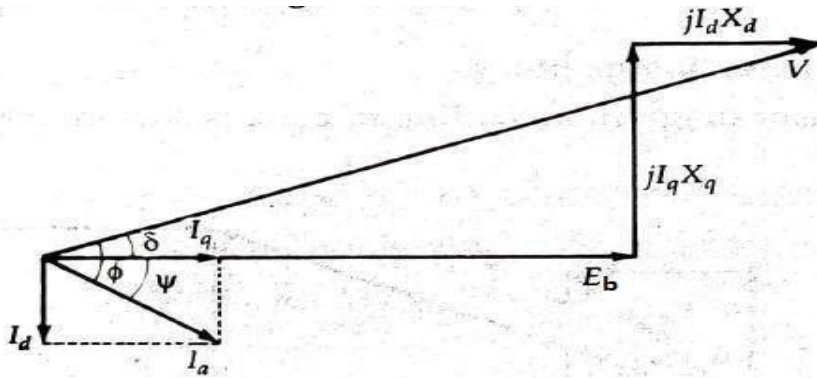

Fig: Phasor diagram of a salient-pole synchronous motor at lagging pf $\cos\Phi$ neglecting the armature resistance R_a

b) Leading power factor $\cos\Phi$

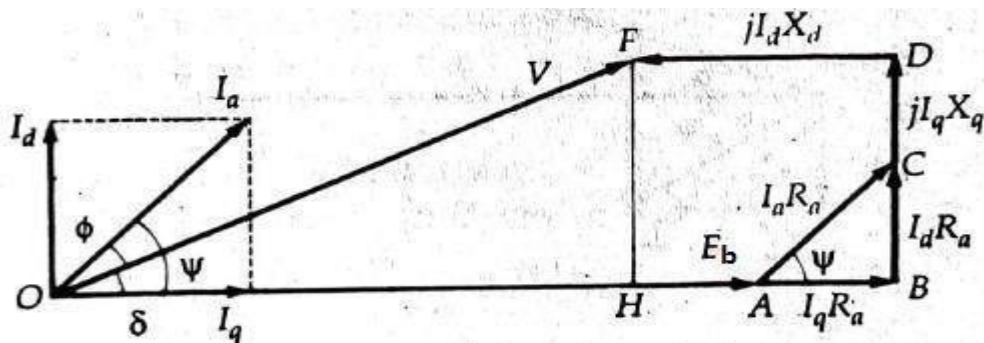

Fig: Phasor diagram of a salient-pole synchronous motor at leading pf $\cos\Phi$

$$OA = E_b, AC = I_a R_a, CD = I_q X_q, DF = I_d X_d$$

$$OF = V, AB = AC \cos \psi = I_a R_a \cos \psi = I_q R_a$$

$$BC = AC \sin \psi = I_a R_a \sin \psi = I_d R_a$$

$$OA = OH + HA = OH + HB - AB = OH + FD = AB$$

$$E_b = V \cos \delta + I_d X_d - I_q R_a$$

$$HF = BD = BC + CD$$

$$V \sin \delta = I_d R_a + I_q X_q$$

$$\psi = \phi + \delta$$

$$I_d = I_a \sin \psi = I_a \sin (\phi + \delta)$$

$$I_q = I_a \cos \psi = I_a \cos (\phi + \delta)$$

$$(V + I_a X_q \sin \phi - I_a R_a \cos \phi) \sin \delta = (I_a X_q \cos \phi + I_a R_a \sin \phi) \cos \delta$$

$$\therefore \tan \delta = \frac{I_a X_q \cos \phi + I_a R_a \sin \phi}{V + I_a X_q \sin \phi - I_a R_a \cos \phi}$$

$$V \sin \delta = I_a R_a \sin (\phi + \delta) + I_a X_q \cos (\phi + \delta)$$

$$= I_a R_a (\sin \phi \cos \delta + \cos \phi \sin \delta) + I_a X_q (\cos \phi \cos \delta - \sin \phi \sin \delta)$$

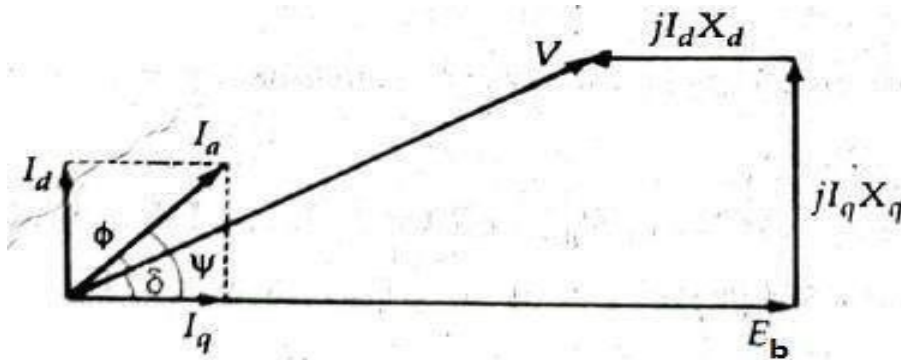

Fig: Phasor diagram of a salient-pole synchronous motor at leading pf $\cos \phi$ neglecting the armature resistance R_a

c) Unity power factor:

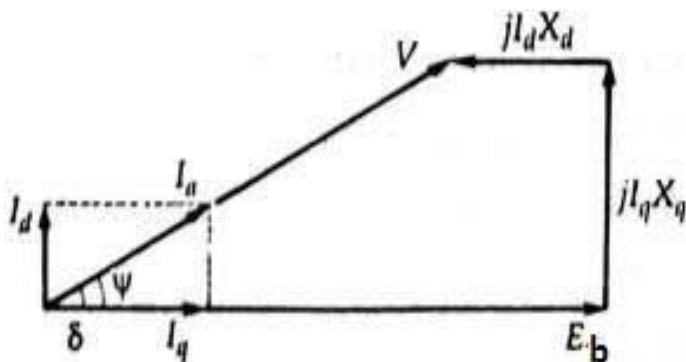

Fig: Phasor diagram of a salient-pole synchronous motor at unity pf $\cos\Phi$ neglecting the armature resistance R_a

$$\cos \phi = 1, \quad \phi = 0^\circ, \quad \sin \phi = 0$$

$$\tan \delta = \frac{I_a X_a}{V - I_a R_a}$$

Synchronous Motor Torque:

The following torques are considered in the selection of a synchronous motor for a particular application:

1. Locked-rotor torque
2. Running torque
3. Pull-in torque
4. Pull-out torque

Locked Rotor Torque

It is the minimum torque at any angular rotor position that is developed with the rotor locked (i.e., stationary) and rated voltage at rated frequency is applied to the terminals. This torque is provided by the stator windings.

Running Torque

It is the torque developed by the motor under running conditions. It is determined by the power rating and speed of the driven machine.

Pull-in torque

A synchronous motor is started as induction motor till it runs 2 to 5 percent below the synchronous speed. The d.c. excitation is then applied and the rotor pulls into step with the synchronously rotating stator field. The pull-in torque is the maximum constant torque at rated voltage and frequency under which a motor will pull a connected load into synchronism when the d.c. motor excitation is applied.

Pull-out torque

It is the maximum value of torque which a synchronous motor can develop at rated voltage and frequency without losing synchronism.

If T_g is the gross armature torque developed by the motor,

$$T_g \times 2\pi N_s = P_m$$

$$T_g = \frac{P_m}{2\pi N_s} \quad (N_s \text{ in rps})$$

$$T_g = \frac{P_m}{2\pi N_s / 60} \quad (N_s \text{ in rpm})$$

$$T_g = \frac{60}{2\pi} \times \frac{P_m}{N_s}$$

$$= 9.55 \frac{P_m}{N_s} \text{ N-m}$$

Gross torque_g

Where $P_m = \text{Gross motor output in watts} = E_b I_a \cos(\delta - \phi)$

$N_s = \text{Synchronous speed in r.p.m.}$

$$= T_{sh} = \frac{P_{out}}{N_s} = 9.55 \text{ N-m}$$

Shaft torque

It may be seen that torque is directly proportional to the mechanical power because rotor speed (i.e., N_s) is fixed.

Mechanical Power Developed by Motor:

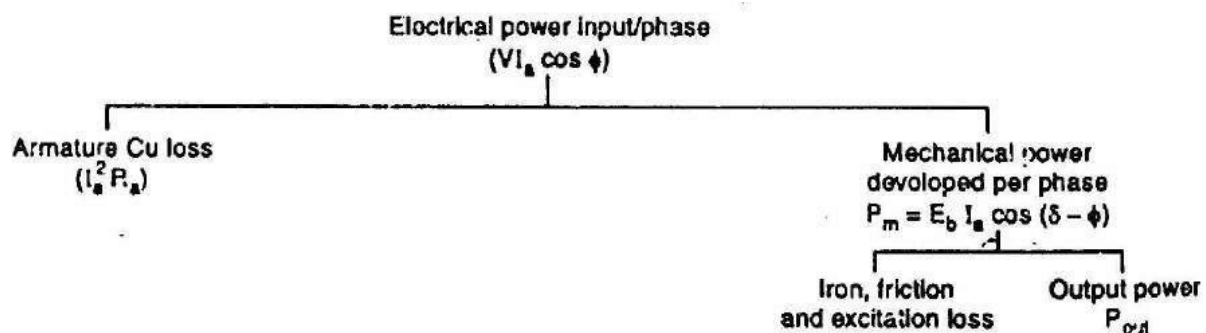

Power Developed by a Cylindrical rotor Synchronous Motor:

Except for very small machines, the armature resistance of a synchronous motor is negligible as compared to its synchronous reactance. The phasor diagram of an under-excited synchronous motor driving a mechanical load neglecting the armature resistance is shown below.

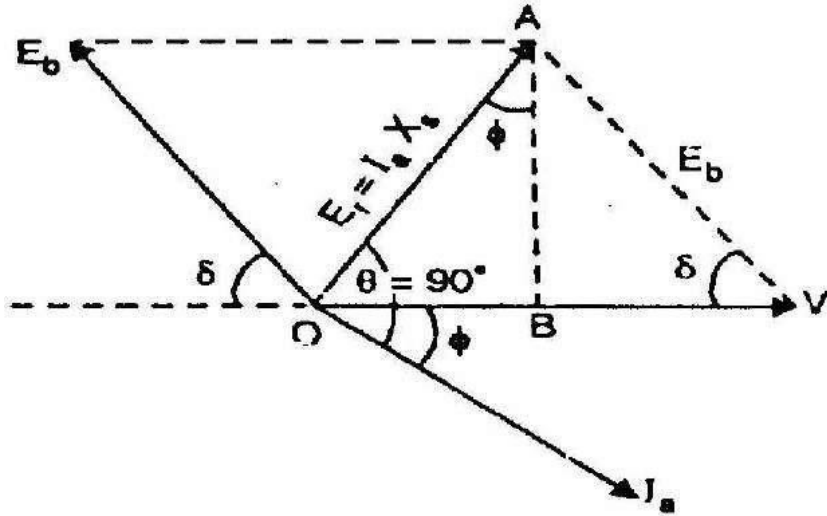

$$\tan\theta = \frac{X_s}{R_a} = \infty$$

Since armature resistance R_a is assumed zero.

and hence $\theta = 90^\circ$

Input power/phase = $V I_a \cos\phi$

Since R_a is assumed zero, stator $\text{Cu loss}(I_a^2 R_a)$ will be zero. Hence input power is equal to the mechanical power P_m developed by the motor.

Mechanical power developed/ phase, $P_m = V I_a \cos\phi$

From the phasor diagram

$$AB = E_b \cos\delta = I_a X_s \cos\phi$$

$$I_a X_s \cos\phi = E_b \sin\delta$$

$$I_a \cos\phi = \frac{E_b \sin\delta}{X_s}$$

$$P_m = \frac{V E_b \sin\delta}{X_s} \text{ per phase}$$

$$P_m = \frac{3V E_b \sin\delta}{X_s} \text{ for 3 phase } P_{max} = \frac{3V E_b}{X_s}$$

$$\text{Also } AB = E_b \sin\delta$$

It is clear from the above relation that mechanical power increases with torque angle (in electrical degrees) and its maximum value is reached when $\delta = 90^\circ$ (electrical).

Power Developed by a Salient-pole Synchronous Motor:

The expressions for the power developed by a salient-pole synchronous motor is same as a salient-pole synchronous generator. The phasor diagram at lagging pf for a salient-pole synchronous generator, neglecting R_a is shown below.

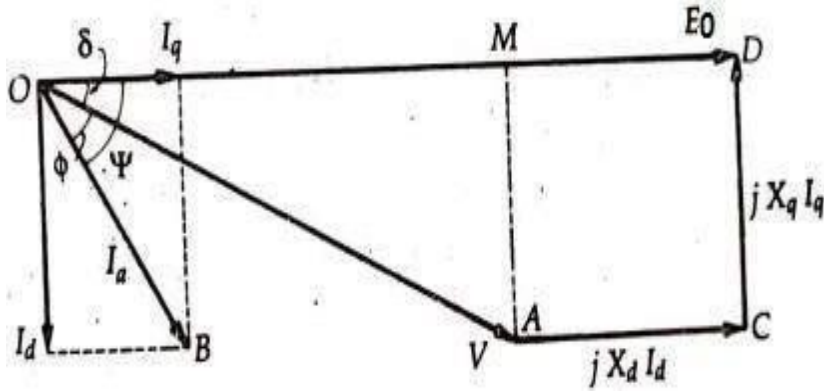

The complex power output per phase

$$S_{1\phi} = \mathbf{V} \mathbf{I}_a^*$$

Taking E_0 as the reference phasor.

$$\therefore \mathbf{V} = V \angle -\delta = V \cos \delta - j V \sin \delta$$

$$\mathbf{I}_a = I_q - j I_d$$

$$\mathbf{I}_a^* = I_q + j I_d$$

$$\therefore S_{1\phi} = \mathbf{V} \mathbf{I}_a^* = (V \cos \delta - j V \sin \delta) (I_q + j I_d)$$

From the phasor diagram

$$X_q I_q = CD = AM = V \sin \delta$$

$$\therefore I_q = \frac{V \sin \delta}{X_q}$$

$$X_d I_d = AC = MD = OD - OM = E_0 - V \cos \delta$$

$$\therefore I_d = \frac{E_0 - V \cos \delta}{X_d}$$

Substituting the values of I_q and I_d

$$S_{1\phi} = (V \cos \delta - j V \sin \delta) \left(\frac{V \sin \delta}{X_q} + j \frac{E_0 - V \cos \delta}{X_d} \right)$$

$$= \left(\frac{V^2}{X_q} \sin \delta \cos \delta + \frac{V E_0}{X_d} \sin \delta - \frac{V^2}{X_d} \sin \delta \cos \delta \right)$$

$$+ j \left(\frac{V E_0}{X_d} \cos \delta - \frac{V^2}{X_d} \cos^2 \delta - \frac{V^2}{X_q} \sin^2 \delta \right)$$

$$= \left[\frac{V E_0}{X_d} \sin \delta + \frac{V^2}{2} \left(\frac{1}{X_q} - \frac{1}{X_d} \right) \sin 2\delta \right]$$

$$+ j \left[\frac{V E_0}{X_d} \cos \delta - \frac{V^2}{2 X_d} (1 + \cos 2\delta) - \frac{V^2}{2 X_q} (1 - \cos 2\delta) \right]$$

$$= \left[\frac{V E_0}{X_d} \sin \delta + \frac{V^2}{2} \left(\frac{1}{X_q} - \frac{1}{X_d} \right) \sin 2\delta \right] \\ + j \left[\frac{V E_0}{X_d} \cos \delta - \frac{V^2}{2 X_d X_q} \{ (X_d + X_q) - (X_d - X_q) \cos 2\delta \} \right]$$

Also, $S_{1\phi} = P_{1\phi} + j Q_{1\phi}$

Therefore the real power per phase in watts is

$$P_{1\phi} = \frac{V E_0}{X_d} \sin \delta + \frac{V^2}{2} \left(\frac{1}{X_q} - \frac{1}{X_d} \right) \sin 2\delta$$

Total real power in watts

$$P_{3\phi} = 3 P_{1\phi} = \frac{3 V E_0}{X_d} \sin \delta + \frac{3 V^2}{2} \left(\frac{1}{X_q} - \frac{1}{X_d} \right) \sin 2\delta$$

The reactive power per phase in vars is

$$Q_{1\phi} = \frac{V E_0}{X_d} \cos \delta - \frac{V^2}{2 X_d X_q} \left[(X_d + X_q) - (X_d - X_q) \cos 2\delta \right]$$

Total reactive power in vars

$$Q_{3\phi} = 3 Q_{1\phi} = \frac{3 V E_0}{X_d} \cos \delta - \frac{3 V^2}{2 X_d X_q} \left[(X_d + X_q) - (X_d - X_q) \cos 2\delta \right]$$

The above equations are applicable to both Salient pole synchronous generator and synchronous motor. The torque angle δ is positive for the generator and negative for the motor.

$\left(\frac{1}{X_q} - \frac{1}{X_d} \right)$ is called saliency. The saliency disappears when $X_d = X_q$

The first term of $P_{1\phi}$ is same as that of cylindrical rotor machine and is called the excitation power and the second term the reluctance power.

Excitation power per phase

$$= \frac{V E_0}{X_d} \sin \delta$$

Reluctance power per phase

$$= \frac{V^2}{2} \left(\frac{1}{X_q} - \frac{1}{X_d} \right) \sin 2\delta$$

Effect of varying load with constant excitation:

A synchronous motor runs at absolutely constant synchronous speed, regardless of the load.

Let us examine the effect of load change on the motor.

Consider a synchronous motor operating initially with a leading power factor. The phasor diagram for leading power factor neglecting R_a is shown below.

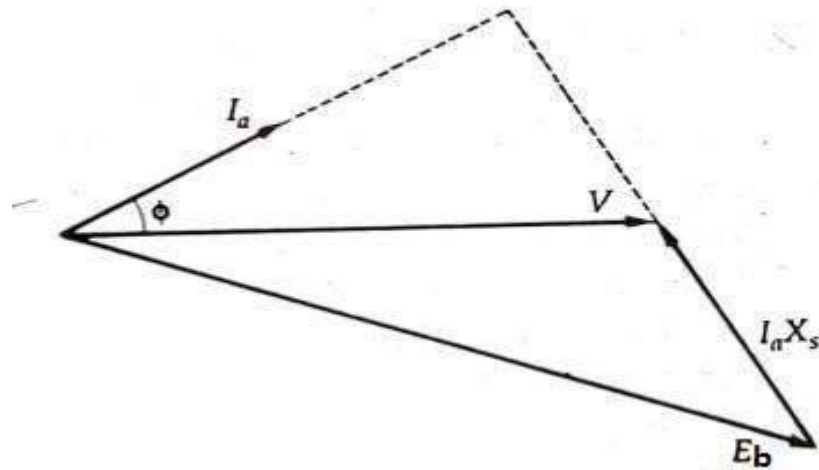

Suppose that the load on the shaft is increased. The rotor slows down momentarily since it takes some time for the motor to take increased power from the line. In other words, although still rotating at synchronous speed, the rotor slips back in space result of increased loading. In this process the torque angle δ becomes larger and therefore the induced torque ($T_{ind} = \frac{VE_b \sin \delta}{\omega X_s}$) increases. The increased torque increases the rotor speed and the motor again picks up the synchronous speed but with a larger torque angle δ . Since the excitation voltage (back emf) E_b , is proportional to $\Phi \omega$, it only depends upon the field current and the speed of the motor. Since the motor is moving with a constant synchronous speed, and since the field the field current remains constant. Therefore, the magnitude of excitation voltage E remains constant with the change in load on the shaft.

$$VE_b \sin \delta$$

$$E_b \sin \delta = \frac{X_s}{V} P = KP \text{ where } K = \frac{X_s}{V} = \text{a constant}$$

We have

$$P = \frac{VE_b \sin \delta}{X_s}$$

These relations show that the increase in P increases $E_b \sin \delta$ and $I_a \cos \phi$. The locus of E_b , is shown in Fig. below. It is seen from Fig. that with the increase of the load, the quantity $jI_a X_s$, goes on increasing so that the relation $V = E_b + jI_a X_s$, is satisfied and therefore the armature current I_a , also increases. It is also seen from Fig. that the power factor angle ϕ also changes. It becomes less and less leading and then becomes more and more lagging.

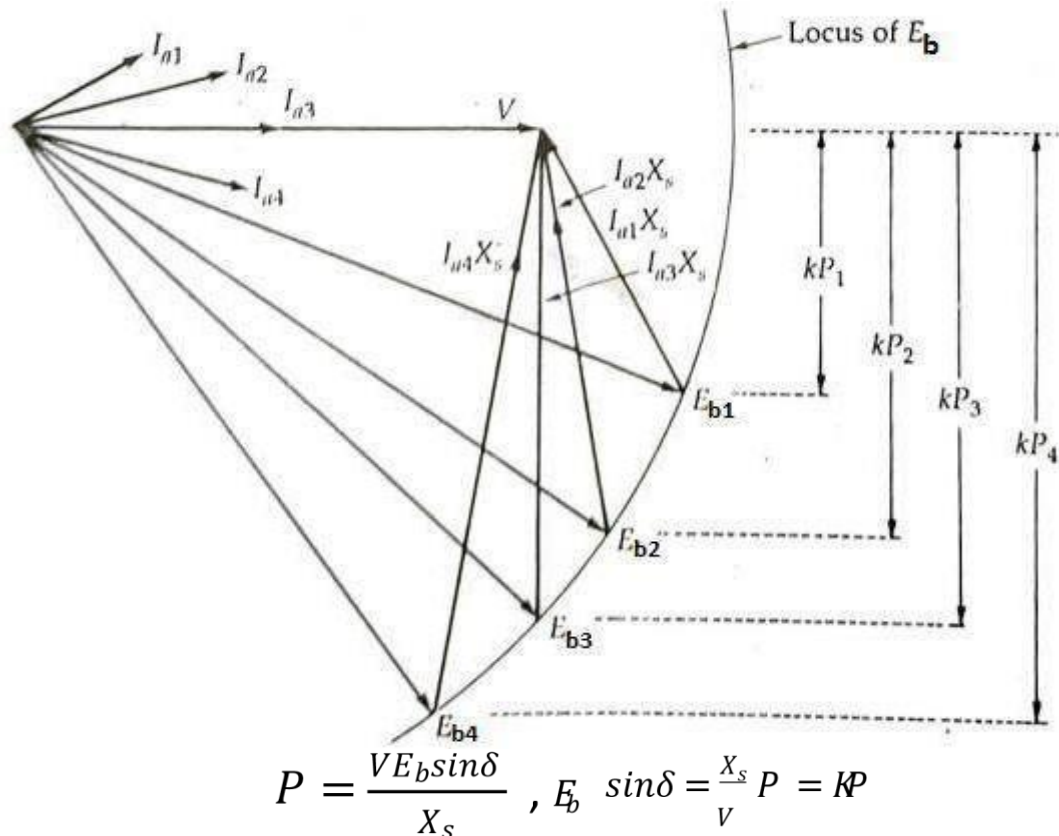

Thus, when the load on a synchronous motor is increased,

- (i) The motor continues to run at synchronous speed
- (ii) The torque angle δ increases.
- (iii) The excitation voltage remains constant.
- (iv) The armature current I_a drawn from the supply increases.
- (v) The phase angle Φ increases in the lagging direction.

There is a limit to the mechanical load that can be applied to asynchronous motor. As the load is increased, the torque angle δ also increases till a stage is reached when the rotor is pulled out of synchronism and the motor is stopped.

Effect of varying excitation with constant load:

In a d.c. motor, the armature current I_a is determined by dividing the difference between V and E_b by the armature resistance R_a . Similarly, in a synchronous motor, the stator current (I_a) is determined by dividing voltage-phasor resultant (E_r) between V and E_b by the synchronous impedance Z_s .

One of the most important features of a synchronous motor is that by changing the field excitation, it can be made to operate from lagging to leading power factor.

Suppose a synchronous motor is operating with normal excitation ($E_b = V$) at unity p.f. with a given load shown in fig(a). If R_a is negligible as compared to X_s , then I_a lags E_r by 90° and is in

phase with V because p.f. is unity. The armature is drawing a power of $V I_a$ per phase which is enough to meet the mechanical load on the motor. Now let us discuss the effect of decreasing or increasing the field excitation when the load applied to the motor remains constant. **a)**

Excitation Decreased

Suppose due to decrease in excitation, back e.m.f. is reduced to E_{b1} at the same load angle δ_1 as shown in fig(b). The resultant voltage E_{r1} causes a lagging armature current I_{a1} to flow. Even though I_{a1} is larger than I_a in magnitude it is incapable of producing necessary power $V I_a$ for carrying the constant load because $I_{a1} \cos \phi_1$ component is less than I_a so that $V I_{a1} \cos \phi_1 <$

$V I_a$.

Hence, it becomes necessary for load angle to increase from δ_1 to δ_2 . It increases back e.m.f. from E_{b1} to E_{b2} which in turn, increases resultant voltage from E_{r1} to E_{r2} . Consequently, armature current increases to I_{a2} whose in-phase component produces enough power ($V I_{a2} \cos \phi_2$) to meet the constant load on the motor.

b) Excitation Increased

The effect of increasing field excitation is shown in Fig.(c) where increased E_{b1} is shown at the original load angle δ_1 . The resultant voltage E_{r1} causes a leading current I_{a1} whose in-phase component is larger than I_a . Hence, armature develops more power than the load on the motor. Accordingly, load angle decreases from δ_1 to δ_2 , which decreases resultant voltage from E_{r1} to E_{r2} . Consequently, armature current decreases from I_{a1} to I_{a2} whose in-phase component $V I_{a2} \cos \phi_2 = I_a$. The armature develops power sufficient to carry the constant load on the motor.

Hence, we find that variations in the excitation of a synchronous motor running with a given load produce variation in its load angle only.

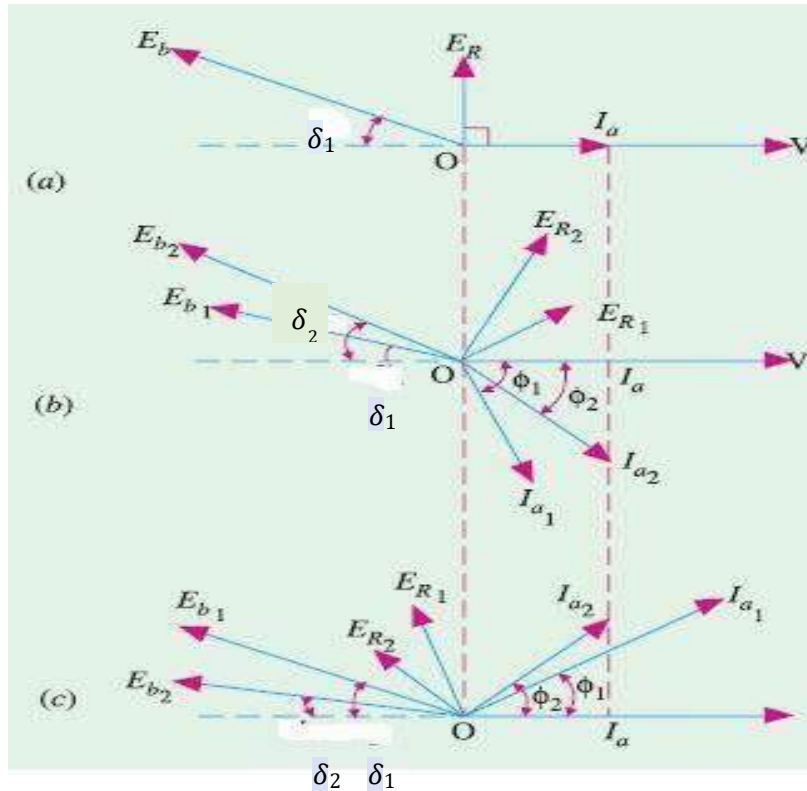

V- Curves and Inverted V-Curves:

Excitation can be increased by increasing the field current passing through the field winding of synchronous motor. If graph of armature current drawn by the motor (I_a) against field current (I_f) is plotted, then its shape looks like an English alphabet V. If such graphs are obtained at various load conditions we get family of curves, all looking like V. Such curves are called V-curves of synchronous motor.

The V-curves of a synchronous motor show how armature current varies with its field current when motor input is kept constant.

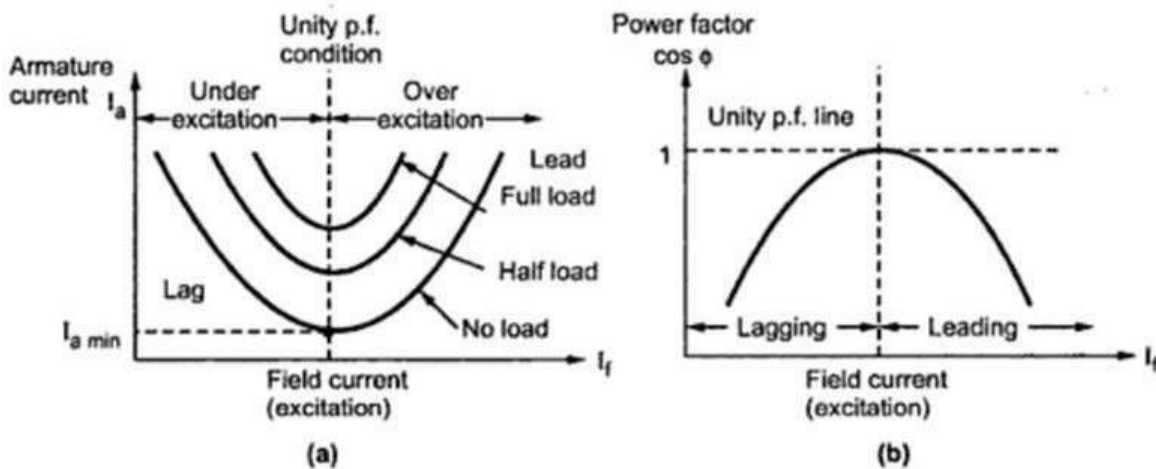

When the level of field excitation of a synchronous motor is changed from under excitation to over excitation for a constant load, then

- i. When the motor is under excited i.e. ($E_b < V$) the PF is lagging. In this case the synchronous motor behaves like an inductive load.
- ii. During normal excitation ($E_b = V$), the PF is unity. In this case I_a will be minimum and it is in phase with terminal voltage.
- iii. When the motor is over excited i.e. ($E_b > V$) the PF is leading. In this case the synchronous motor behaves like capacitive load. In over excited state the synchronous motor will deliver load torque and improves the PF of a 3-phase supply.

If the power factor ($\cos \Phi$) is plotted against field current I_f , then the shape of the graph looks like an inverted V. Such curves obtained by plotting p.f. against I_f at various load conditions are called Inverted V-curves of synchronous motor.

Typically, the synchronous machine V-curves are provided by the manufacturer so that the user can determine the resulting operation under a given set of conditions.

Power angle characteristics of cylindrical rotor motor:

The power output of an alternator is given by: Power

$$P = \frac{VE_b}{X_s} \sin \delta$$

output/phase, Total power $\frac{3VE_b}{X} \sin \delta$ output =

The power output varies sinusoidally with power angle δ . The synchronous motor delivers maximum power when $\delta = 90^\circ$. If δ becomes greater than 90° , the machine will lose synchronism. The dotted portion of the curve refers to unstable operation, i.e., machine loses synchronism.

Stability of the synchronous motor is determined by the power/power angle characteristic. Suppose the operating position of the alternator is represented by point P on the curve. If unsteadiness occurs due to a transient spike of mechanical input, then load angle δ increases by a small amount. The additional electrical output caused by an increase in δ produces a torque which is not balanced by the driving torque once the spike has passed. This torque causes retardation of the rotor and the synchronous motor returns to the operating point P. The torque causing the return of the synchronous motor to the steady-state position is called the synchronizing torque and the power associated with it is known as synchronizing power.

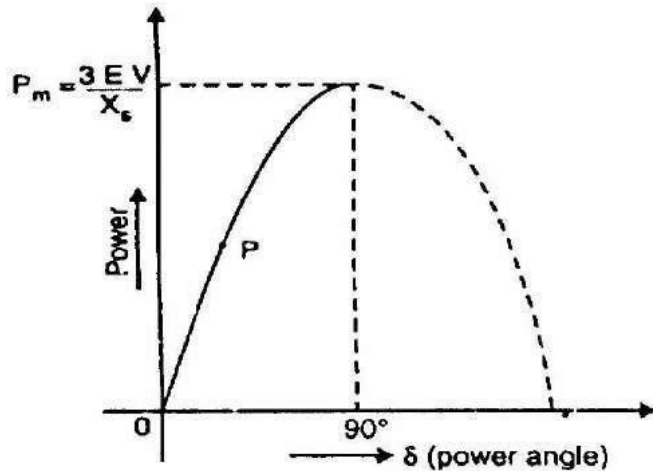

Power angle characteristics of Salient pole synchronous motor:

The real power of Salient pole synchronous motor per phase is given by

$$P_{1\phi} = \frac{VE_0}{X_d} \sin\delta + \frac{V^2}{2} \left[\frac{1}{X_q} - \frac{1}{X_d} \right] \sin 2\delta \quad 1 \quad 1$$

The Excitation power per phase

$$= \frac{VE_0}{X_d} \sin\delta$$

Reluctance power per phase

$$= \frac{V^2}{2} \left[\frac{1}{X_q} - \frac{1}{X_d} \right] \sin 2\delta$$

It is clear that reluctance power varies with at twice the rate of the excitation power. The peak power is seen to be displaced towards $\delta=0$, the amount of displacement depends upon the excitation. The excitation is such that the excitation term has peak value about 2.5 times that of the reluctance term. Under steady state conditions, the reluctance term is positive because $X_d > X_q$.

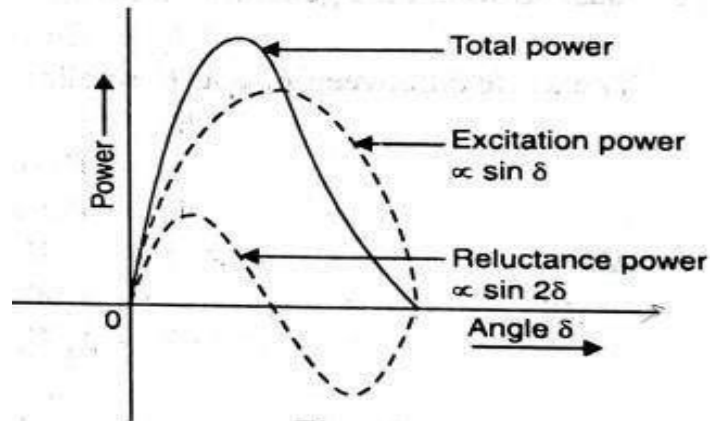

Synchronous Condenser:

A synchronous motor takes a leading current when over-excited and, therefore, behaves as a capacitor.

An over-excited synchronous motor running on no-load is known as synchronous condenser. It is also known as synchronous capacitor or synchronous compensator or synchronous phase modifier.

When such a machine is connected in parallel with induction motors or other devices that operate at low lagging power factor, the leading kVAR supplied by the synchronous condenser partly neutralizes the lagging reactive kVAR of the loads. Consequently, the power factor of the system is improved.

Figure shown below shows the power factor improvement by synchronous condenser method. The 3-phase load takes current I_L at low lagging power factor $\cos \phi_L$. The synchronous condenser takes a current I_m which leads the voltage by an angle ϕ_m . The resultant current I is the vector sum of I_m and I_L and lags behind the voltage by an angle ϕ . It is clear that ϕ is less than ϕ_L so that $\cos \phi$ is greater than $\cos \phi_L$. Thus the power factor is increased from $\cos \phi_L$ to $\cos \phi$. Synchronous condensers are generally used at major bulk supply substations for power factor improvement.

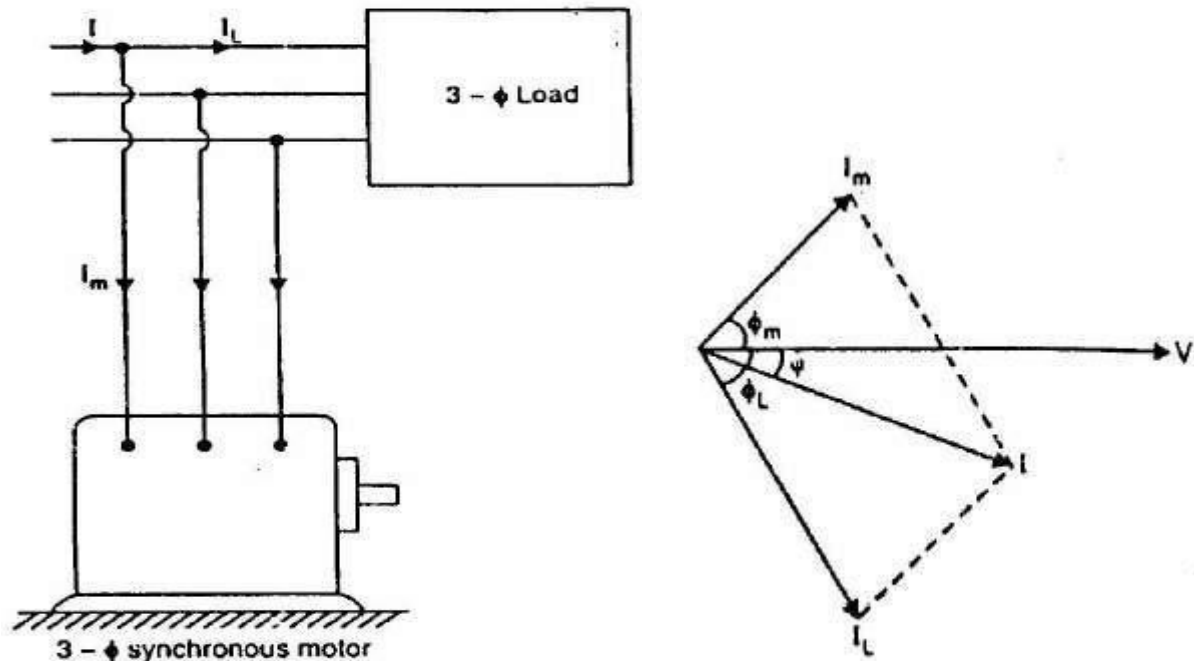

Advantages

- (i) By varying the field excitation, the magnitude of current drawn by the motor can be changed by any amount. This helps in achieving step less control of power factor.
- (ii) The motor windings have high thermal stability to short circuit currents.
- (iii) The faults can be removed easily.

Disadvantages

- (i) There are considerable losses in the motor.
- (ii) The maintenance cost is high.
- (iii) It produces noise.
- (iv) Except in sizes above 500 KVA, the cost is greater than that of static capacitors of the same rating.
- (v) As a synchronous motor has no self-starting torque, then-fore, an auxiliary equipment has to be provided for this purpose.

Hunting in Synchronous Motor:

Sudden changes of load on synchronous motors may sometimes set up oscillations that are superimposed upon the normal rotation, resulting in periodic variations of a very low frequency in speed. This effect is known as hunting or phase-swinging or surging. If the time period of these oscillations happens to be equal to the natural time period of the machine, then mechanical resonance is set up. The amplitude of these oscillations is built up to a large value and may become so great as to throw the machine out of synchronism.

Causes of hunting:

1. Sudden changes of load
2. Faults occurring in the system which the generator supplies
3. Sudden changes in the field current
4. Cyclic variations of the load torque.

Effects of hunting

1. It can lead to loss of synchronism.
2. It can cause variations of the supply voltage producing undesirable lamp flicker.
3. It increases the possibility of resonance. If the frequency of the torque component becomes equal to that of the transient oscillations of the synchronous machine, resonance may take place.
4. Large mechanical stresses may develop in the rotor shaft.
5. The machine losses increase and the temperature of the machine rises. Of these effects, the first is the most important phenomenon to be avoided.

Reduction of hunting

The following are some of the techniques used to reduce hunting:

1. Damper windings
2. Use of flywheels
The prime mover is provided with a large and heavy flywheel. This increases the inertia of the prime mover and helps in maintaining the rotor speed constant.
3. By designing synchronous machines with suitable synchronizing power coefficients.

Damper winding:

The damper windings consist of short-circuited Cu bars embedded in the faces of the field poles of the motor. The ends of the damper bars are short circuited at the ends by short circuiting rings similar to end rings as in the case of squirrel cage rotors. Under normal running conditions, the damper winding does not carry any current because rotor runs at synchronous speed. Whenever any irregularity takes place in the speed of rotation, however, the polar flux moves from side to side of the pole, this movement causing the flux to move backwards and forwards across the damper bars. Emfs are induced in the damper bars.

These damper windings are serving the function of providing mechanical balance, reduce the effect of over voltages and damp out hunting in case of alternators. In case of synchronous motors, they act as rotor bars and help in self-starting of the motor.

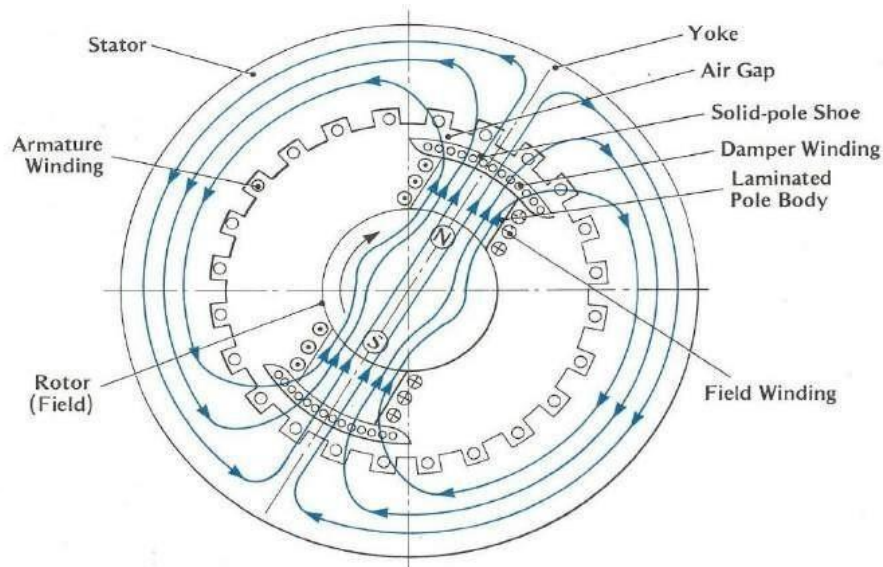

Methods of starting synchronous motor:

A synchronous motor is not self-starting. There are two methods that are used to start a synchronous motor:

1. Starting with the help of an external prime mover.
2. Starting with the help of damper windings.

Motor Starting with an External Motor:

In this method an external motor drives the synchronous motor and bring it to synchronous speed. The synchronous machine is then synchronized with the bus-bar as a synchronous generator. The prime mover is then disconnected. The synchronous machine will work as a motor. Now the load can be connected to the synchronous motor. Since load is not connected to the synchronous motor before synchronizing, the starting motor has to overcome the inertia of the synchronous motor at no load. Therefore, the rating of the starting motor is much smaller than the rating of the synchronous motor.

Generally, most of the large synchronous motors are provided with brushless excitation systems mounted on their shafts. These exciters are used as the starting motors.

Motor Starting by using damper (Amortisseur) Winding:

The most widely used method of starting a synchronous motor is to use damper windings. Most of the large synchronous motors are provided with damper windings, in order to nullify the oscillations of the rotor whenever the synchronous machine is subjected to a periodically varying load. A damper winding consists of heavy copper bars inserted in slots of the pole faces of the rotor. These bars are short circuited by end rings at both ends of the rotor similar to the squirrel cage rotor bars.

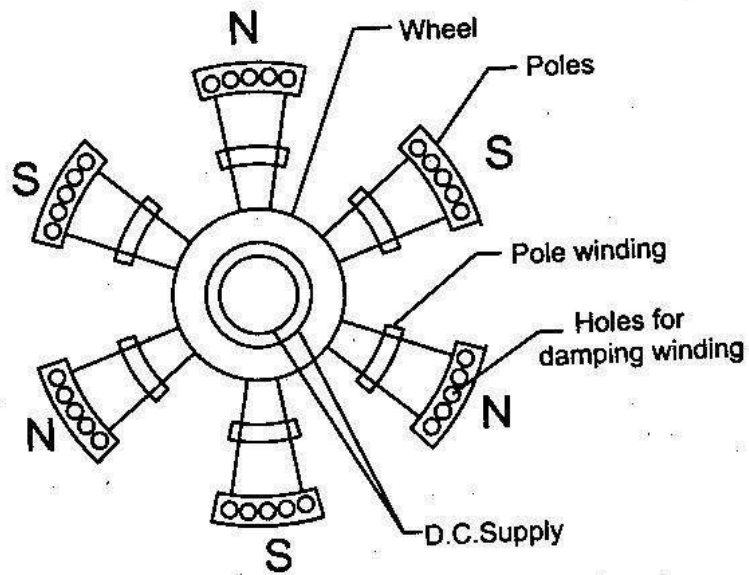

When the stator of a synchronous motor is connected to the 3-Phase AC supply, the motor starts as a 3-Phase induction machine due to the presence of the damper bars, just like a squirrel cage induction motor. Once the motor picks up to a speed near about its synchronous speed, the DC supply to its field winding is connected and the synchronous motor pulls into step i.e. it continues to operate as a Synchronous motor running at its synchronous speed.

Applications of Synchronous Motors:

Synchronous motors find extensive application for the following classes of service:

1. Power factor correction
2. Constant-speed, constant-load drives
3. Voltage regulation

Power factor correction

Overexcited synchronous motors having leading power factor are widely used for improving power factor of those power systems which employ a large number of induction motors and other devices having lagging p.f. such as welders and fluorescent lights etc.

Constant-speed applications

Because of their high efficiency and high-speed, synchronous motors (above 600 r.p.m.) are well-suited for loads where constant speed is required such as centrifugal pumps, belt-driven reciprocating compressors, blowers, line shafts, rubber and paper mills etc.

Low-speed synchronous motors (below 600 r.p.m.) are used for drives such as centrifugal and screw-type pumps, ball and tube mills, vacuum pumps, clippers and metal rolling mills etc.

Voltage regulation

The voltage at the end of a long transmission line varies greatly especially when large inductive loads are present. When an inductive load is disconnected suddenly, voltage tends to rise considerably above its normal value because of the line capacitance. By installing a synchronous motor with a field regulator (for varying its excitation), this voltage rise can be controlled.

When line voltage decreases due to inductive load, motor excitation is increased, thereby raising its p.f. which compensates for the line drop. If line voltage rises due to line capacitive effect, motor excitation is decreased, thereby making its p.f. lagging which helps to maintain the line voltage at its normal value.

Chapter-3

THREE PHASE INDUCTION MOTOR

An Induction machines is basically ***Asynchronous machines***. If the Induction Machine converts Mechanical energy to Electrical energy, then it is called Induction Generator. If the Induction Machine converts Electrical energy to Mechanical energy, then it is called Induction Motor.

The induction motor may be considered to be a transformer with a rotating secondary and it can, therefore, be described as a “transformer type” a.c. machine in which electrical energy is converted into mechanical energy.

Production of rotating magnetic field:

When a 3-phase winding is energized from a 3-phase supply, a rotating magnetic field is produced. This field is such that its poles do no remain in a fixed position on the stator but go on shifting their positions around the stator. For this reason, it is called a rotating Field.

Consider a 2-pole,3-phase winding placed 120°space apart. The three phases X, Y and Z are energized from a 3-phase source and currents in these phases are indicated as I_x , I_y and I_z . The fluxes due to these these currents are ϕ_x , ϕ_y and ϕ_z .

$$\begin{aligned}\phi_x &= \phi_m \sin \omega t \\ \phi_y &= \phi_m \sin(\omega t - 120^\circ) \\ \phi_z &= \phi_m \sin(\omega t - 240^\circ)\end{aligned}$$

Here ϕ_m is the maximum flux due to any phase. The phasor diagram of the three fluxes is shown in Fig:(i) below.

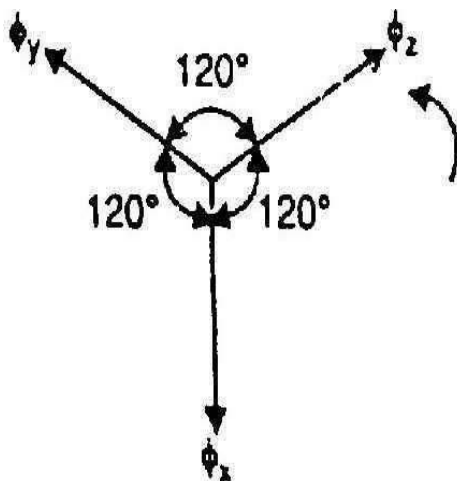

Fig: (i)

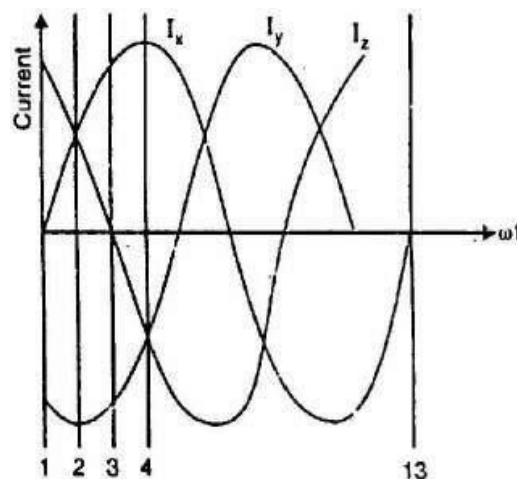

Fig: (ii)

- i. At instant 1, From Fig: (ii), the current in phase X is zero and currents in phases Y and Z are equal and opposite. The currents are flowing outward in the top conductors and inward in the bottom conductors. This establishes a resultant flux towards right.

The magnitude of the resultant flux is constant and is equal to $1.5 \phi_m$.

At instant 1, $\omega t = 0^\circ$.

$$I_x = 0$$

$$\text{i.e. } \phi_x = \phi_m \sin(\omega t)$$

= 0

$$\phi_y = \phi_m \sin(\omega t - 120^\circ) = \phi_m \sin(-120^\circ) = -\frac{\sqrt{3}}{2} \phi_m$$

$$\phi_z = \phi_m \sin(\omega t - 240^\circ) = \phi_m \sin(-240^\circ) = \frac{\sqrt{3}}{2} \phi_m$$

resultant flux

$$\sqrt{3}$$

The phasor sum of ϕ_y and $\frac{\sqrt{3}}{2} \phi_z$ is the resultant flux, $\phi_r = 2 \times \frac{\sqrt{3}}{2} \phi_m \cos(60^\circ) = 1.5 \phi_m$

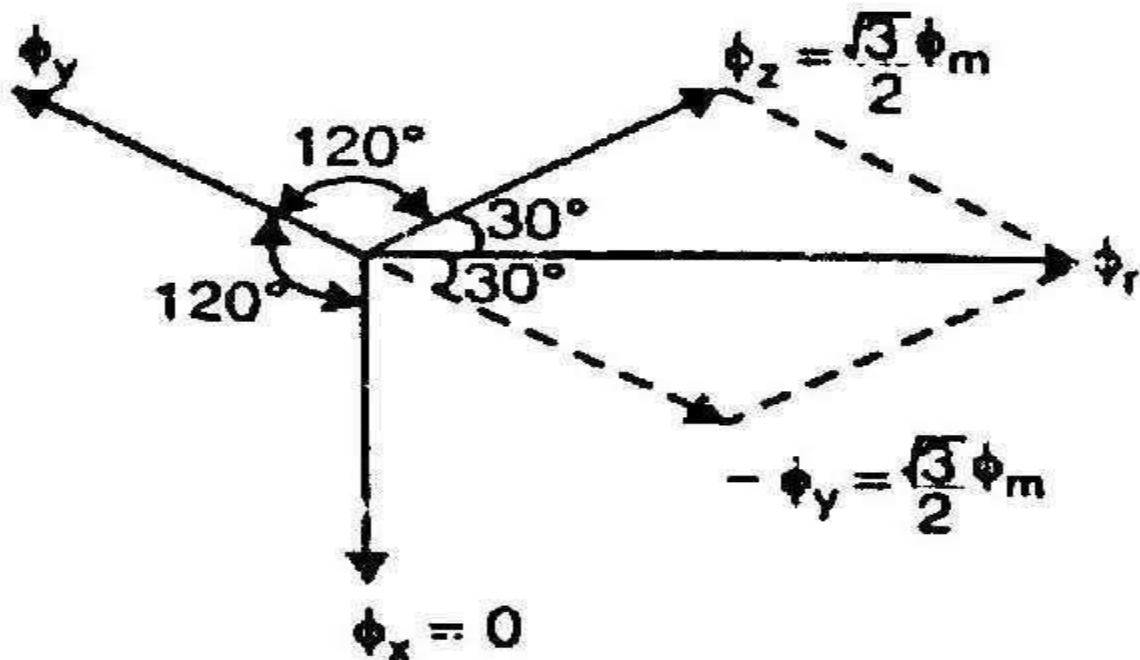

- ii. At instant 2, the current is maximum (negative) in ϕ_y phase Y and 0.5 maximum (positive) in phases X and Z.

$$2, \omega t = 30^\circ.$$

$$\phi_x = \phi_m \sin(\omega t) = \phi_m \sin(30^\circ) = \frac{\phi_m}{2}$$

$$\phi_y = \phi_m \sin(\omega t - 120^\circ) = \phi_m \sin(-90^\circ) = -\phi_m$$

$$\text{At instant } \phi_z = \phi_m \sin(\omega t - 240^\circ) = \phi_m \sin(-210^\circ) = \frac{\phi_m}{2}$$

The phasor sum of ϕ_x , ϕ_y and ϕ_z is the resultant flux ϕ_r

The phasor sum of ϕ_x and ϕ_z , $\phi'_r = 2 \times \frac{\phi_m}{2} \cos\left(\frac{120^\circ}{2}\right) = \phi_m$

The phasor sum of ϕ'_r and $-\phi_y$, $\phi_r = \frac{\phi_m}{2} + \phi_m^2 = 1.5 \phi_m^2$

The resultant flux is displaced 30° clockwise from position 1.

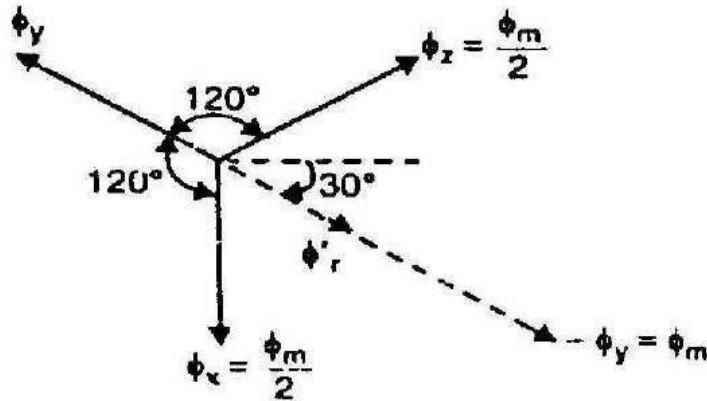

- iii. At instant 3, current in phase Z is zero and the currents in phases X and Y are equal and opposite (currents in phases X and Y are $0.866 \times \text{max. value}$). At instant 3, $\omega t = 60^\circ$.

$$\phi_x = \phi_m \sin(\omega t) = \phi_m \sin(60^\circ) = \frac{\sqrt{3}}{2} \phi_m$$

$$\phi_y = \phi_m \sin(\omega t - 120^\circ) = \phi_m \sin(-60^\circ) = -\frac{\sqrt{3}}{2} \phi_m$$

$$\phi_z = \phi_m \sin(\omega t - 240^\circ) = \phi_m \sin(-180^\circ) = 0$$

The resultant phasor sum $\phi_r = 2 \times \frac{\sqrt{3}}{2} \phi_m \cos(60^\circ) = 1.5 \phi_m$ flux ϕ_r is the resultant of $-\phi_y$ and ϕ_x flux,

$$\phi_r = 2 \times \frac{\sqrt{3}}{2} \phi_m \cos\left(\frac{60^\circ}{2}\right) = 1.5 \phi_m$$

The resultant flux is displaced 60° clockwise from position 1.

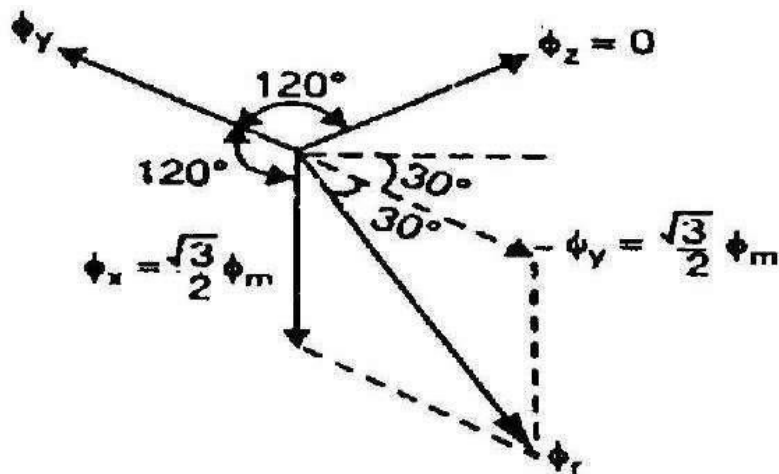

- iv. At instant 4, the current in phase X is maximum (positive) and the currents in phases Y and Z are equal and negative (currents in phases Y and Z are $0.5 \times \text{max. value}$). This establishes a resultant flux downward.

4, $\omega t = 90^\circ$.

$$\phi_x = \phi_m \sin(\omega t) = \phi_m \sin(90^\circ) = \phi_m$$

$$\phi_y = \phi_m \sin(\omega t - 120^\circ) = \phi_m \sin(-30^\circ) = -\frac{\phi_m}{2}$$

$$\phi_z = \phi_m \sin(\omega t - 240^\circ) = \phi_m \sin(-150^\circ) = -\frac{\phi_m}{2}$$

At instant

The phasor sum of ϕ_x , ϕ_y and ϕ_z is the resultant flux ϕ_r . The phasor sum of ϕ_y and ϕ_z is $-\phi$ and $-\phi$, $\phi = 2 \times \frac{\phi_m}{2} \cos(90^\circ) = \phi_m$

The phasor sum of ϕ_x and $-\phi$ is $\phi_r = \phi_m \cos(90^\circ) = \phi_m$

$$\phi_r = \phi_x + (-\phi) = \phi_m - \phi_m = 0$$

The phasor sum of ϕ_x , ϕ_y and ϕ_z is $\phi_r = \phi_m - \frac{\phi_m}{2} - \frac{\phi_m}{2} = 0$

The resultant flux is displaced 90° clockwise from position 1 which is in the downward direction.

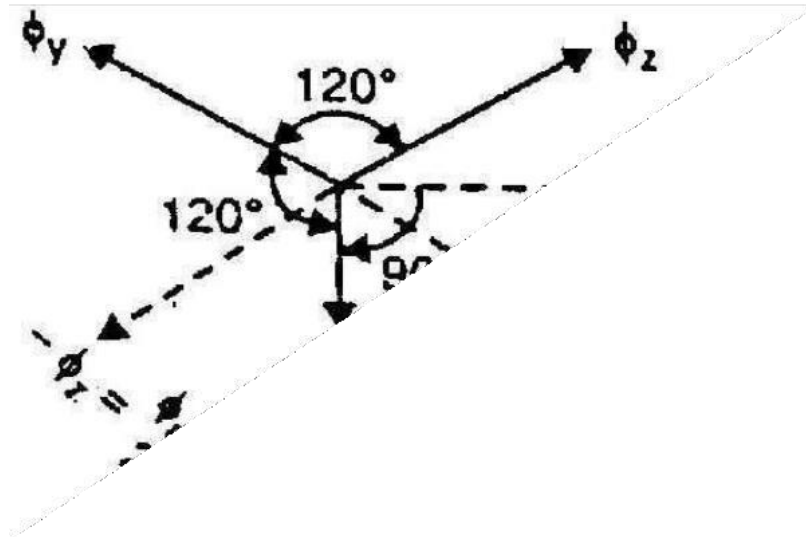

Thus a 3-phase supply produces a rotating field of constant value ($=1.5 \phi_m$, where ϕ_m is the maximum flux due to any phase).

Speed of rotating magnetic field:

The speed at which the rotating magnetic field revolves is called the synchronous speed (N_s).

$$N_s = \frac{120f}{P}$$

Where f = frequency in HZ

P = number of poles **Direction of rotating magnetic field:**

The phase sequence of the three-phase voltage applied to the stator winding is X-Y-Z. If this sequence is changed to X-Z-Y, it is observed that direction of rotation of the field is reversed i.e., the field rotates counterclockwise rather than clockwise.

However, the number of poles and the speed at which the magnetic field rotates remain unchanged. Thus it is necessary only to change the phase sequence in order to change the direction of rotation of the magnetic field. For a three-phase supply, this can be done by

interchanging any two of the three lines. The rotor in a 3-phase induction motor runs in the same direction as the rotating magnetic field. Therefore, the direction of rotation of a 3-phase induction motor can be reversed by interchanging any two of the three motor supply lines.

Construction:

A 3-phase induction motor has two main parts (i) stator and (ii) rotor. The rotor is separated from the stator by a small air-gap which ranges from 0.4 mm to 4 mm, depending on the power of the motor.

Stator:

- Stator consists of a steel frame which encloses a hollow, cylindrical core made up of thin laminations of silicon steel to reduce eddy current losses. A number of evenly spaced slots is provided on the inner periphery of the laminations.
- Stator carries 3-phase winding and is fed from a 3-phase supply. The 3-phase stator winding is wound for a definite number of poles as per requirement of speed. Greater the number of poles, lesser is the speed of the motor and vice-versa.
- When 3-phase supply is given to the stator winding, a rotating magnetic field of constant magnitude is produced. This rotating field induces currents in the rotor by electromagnetic induction.

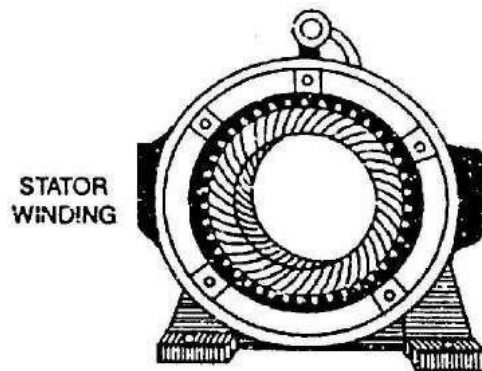

Rotor

The rotor, mounted on a shaft, is a hollow laminated core having slots on its outer periphery. The winding placed in these slots (called rotor winding) may be one of the following two types:

- (i) Squirrel cage type
- (ii) Wound type

Squirrel-cage rotor:

- It consists of a laminated cylindrical core having parallel slots on its outer periphery. One copper or aluminum bar is placed in each slot. All these bars are joined at each end by metal rings called end rings. This forms a permanently short-circuited winding which is indestructible.

- The rotor is not connected electrically to the supply but has current induced in it by transformer action from the stator.
- Those induction motors which employ squirrel cage rotor are called squirrel cage induction motors.
- Most of 3-phase induction motors use squirrel cage rotor as it has a remarkably simple and robust construction enabling it to operate in the most adverse circumstances.
- It suffers from the disadvantage of a low starting torque. It is because the rotor bars are permanently short-circuited and it is not possible to add any external resistance to the rotor circuit to have a large starting torque.

The rotor slots are usually not quite parallel to the shaft but are purposely given a slight skew. This is useful in two ways:

- i. It helps to make the motor run quietly by reducing the magnetic hum and
- ii. It helps in reducing the locking tendency of the rotor i.e. the tendency of the rotor teeth to remain under the stator teeth due to direct magnetic attraction between the two.

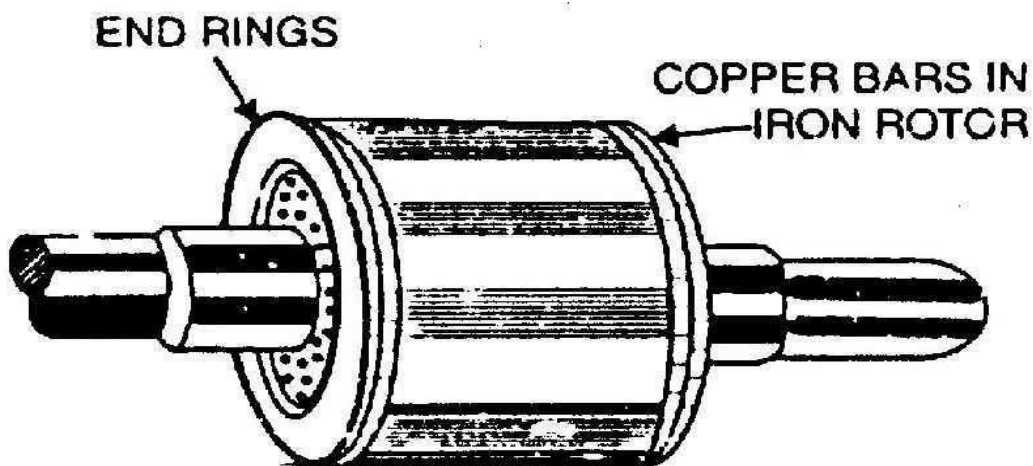

Wound rotor.

- It consists of a laminated cylindrical core and carries a 3- phase winding, similar to the one on the stator.
- The rotor winding is uniformly distributed in the slots and is usually star-connected. The open ends of the rotor winding are brought out and joined to three insulated slip rings mounted on the rotor shaft with one brush resting on each slip ring.
- The three brushes are connected to a 3-phase star-connected rheostat. This makes possible the introduction of additional resistance in the rotor circuit during the starting period for increasing the starting torque of the motor.
- At starting, the external resistances are included in the rotor circuit to give a large starting torque. These resistances are gradually reduced to zero as the motor runs up to speed.

- The external resistances are used during starting period only. When the motor attains normal speed, the three brushes are short-circuited so that the wound rotor runs like a squirrel cage rotor.

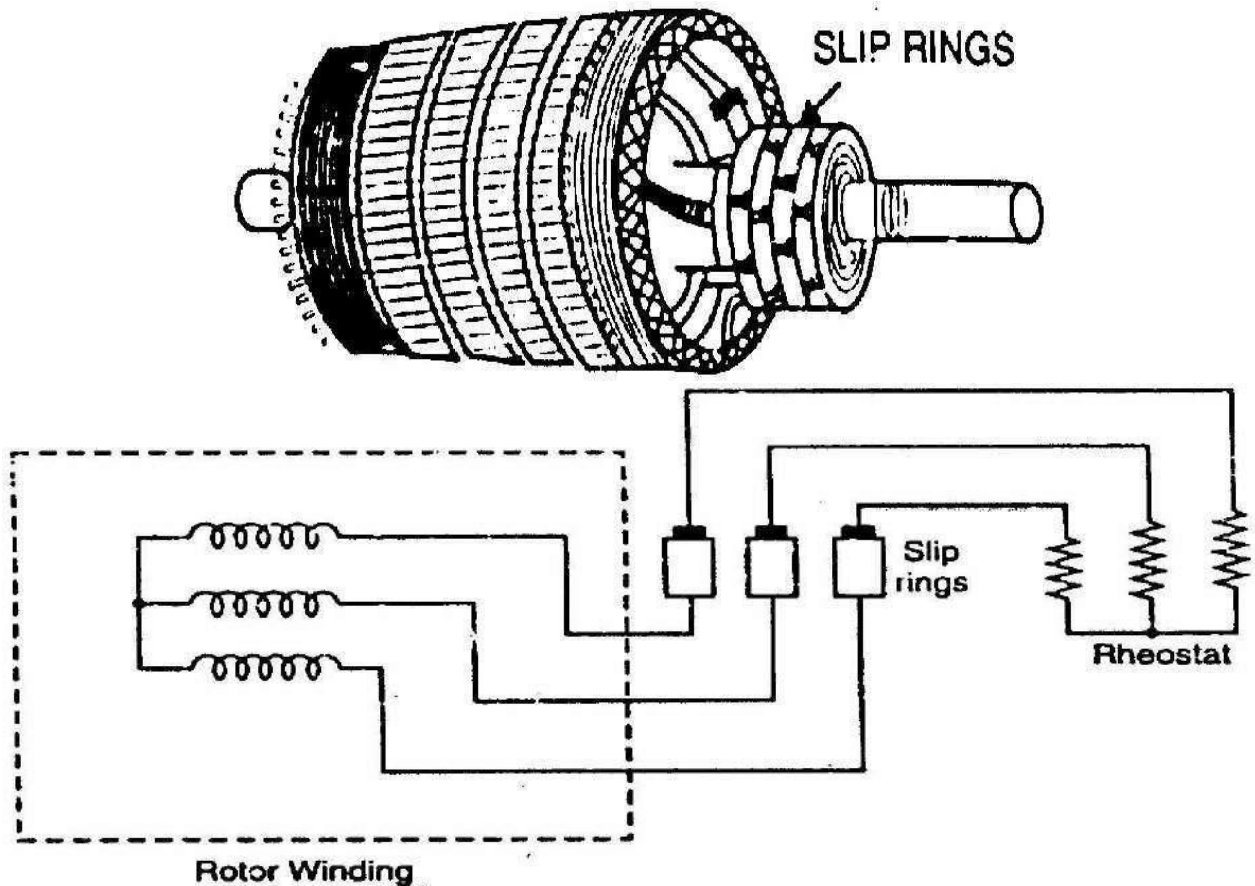

Principle of Operation:

- (i) When 3-phase stator winding is energized from a 3-phase supply, a rotating magnetic field is set up which rotates round the stator at synchronous speed $N_s (= 120 f/P)$.
- (ii) The rotating field passes through the air gap and cuts the rotor conductors, which are stationary. Due to the relative speed between the rotating flux and the stationary rotor, e.m.f.s are induced in the rotor conductors. Since the rotor circuit is short-circuited, currents start flowing in the rotor conductors.
- (iii) The current-carrying rotor conductors are placed in the magnetic field produced by the stator. Consequently, mechanical force acts on the rotor conductors. The sum of the mechanical forces on all the rotor conductors produces a torque which tends to move the rotor in the same direction as the rotating field.
- (iv) According to Lenz's law, the direction of rotor currents will be such that they tend to oppose the cause producing them. The cause producing the rotor currents is the relative speed between the rotating field and the stationary rotor conductors. Hence to reduce this relative speed, the rotor starts running in the same direction as that of stator field and tries to catch it.

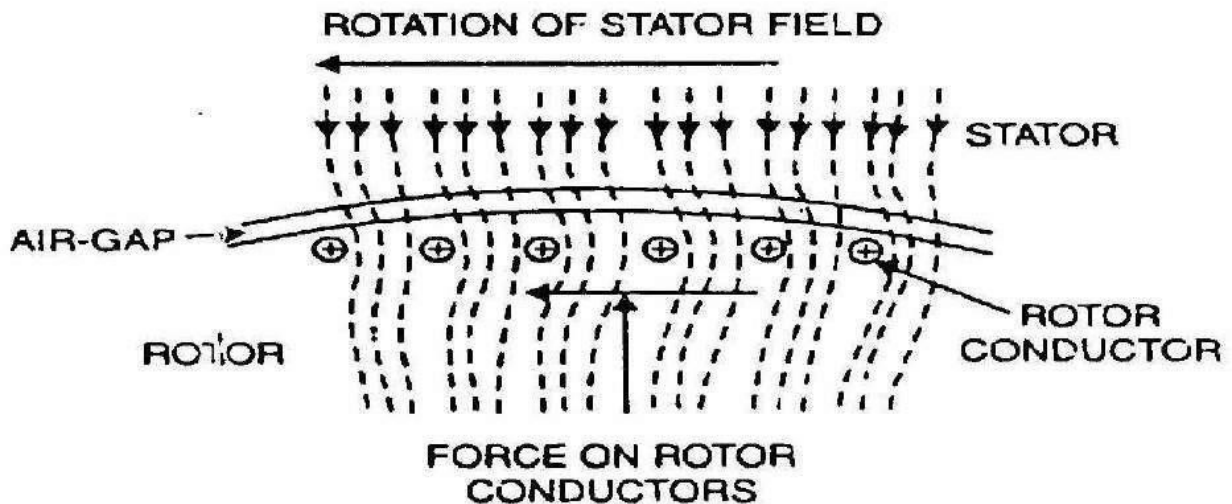

Speed and Slip:

The rotor rapidly accelerates in the direction of rotating field. However the rotor can never reach the speed of stator flux. If rotor is rotating at synchronous speed, then there would be no relative speed between the stator field and rotor conductors, no cutting of flux by the rotor conductors and there would be no generated voltages, no induced rotor currents and, therefore, no torque to drive the rotor. The friction and windage would immediately cause the rotor to slow down. Hence, the rotor speed (N_r) is always less than the stator field speed (N_s). This difference in speed depends upon load on the motor.

The difference between the synchronous speed N_s of the rotating stator field and the actual rotor speed (N_r) is called slip.

It is usually expressed as percentage of synchronous speed i.e.,

$$\% \text{ slip } s = \frac{N_s - N_r}{N_s} \times 100$$

$$N_r = N_s(1 - s)$$

- i. The quantity $N_s - N_r$ is sometimes called slip speed.
- ii. When the rotor is stationary (i.e., $N_r = 0$), slip, $s = 1$ or 100 %.
- iii. In an induction motor, the change in slip from no-load to full-load is hardly 0.1% to 3% so that it is essentially a constant-speed motor.

Frequency of Rotor Current and Voltage:

The frequency of a voltage or current induced due to the relative speed between a winding and a magnetic field is given by

$$\text{Frequency } f = \frac{PN}{120}$$

where N = Relative speed between magnetic field and the winding
 P = Number of poles

For a rotor speed N_r , the relative speed between the rotating flux and the rotor is $N_s - N_r$. Consequently, the rotor current frequency

$$f_r = \frac{(N_s - N_r)P}{120}$$

$$= \frac{sN_sP}{120}$$

$$f_r = sf$$

Rotor current frequency = slip x Supply frequency

- i. When the rotor is at standstill or stationary (i.e., $s = 1$), the frequency of rotor current is the same as that of supply frequency ($f_r = sf = 1 \times f = f$)
- ii. As the rotor picks up speed, the relative speed between the rotating flux and the rotor decreases. Consequently, the slip s and hence rotor current frequency decreases.

Rotor EMF and Reactance:

Let E_2 = standstill rotor induced e.m.f./phase

X_2 = standstill rotor reactance/phase. f = rotor current frequency at standstill

When rotor is stationary i.e. $s = 1$. the frequency of rotor e.m.f. is the same as that of the stator supply frequency. The value of e.m.f. induced in the rotor at standstill is maximum because the relative speed between the rotor and the revolving stator flux is maximum. In fact, the motor is equivalent to a 3-phase transformer with a short-circuited rotating secondary.

When rotor starts running, the relative speed between rotor and the rotating stator flux is decreased. Hence, the rotor induced e.m.f. which is directly proportional to this relative speed, is also decreased. Hence, for a slip s the rotor induced e.m.f. will be s times the induced e.m.f. at standstill.

Therefore, under running conditions $E_r = sE_2$.

The frequency of the induced e.m.f. will $f_r = sf$

Due to decrease in frequency of the rotor e.m.f.. the rotor reactance will also decrease. $X_r = sX_2$ where E_r and X_r are rotor e.m.f. and reactance under running conditions

Thus at any slip s ,

Rotor e.m.f./phase = sE_2

Rotor reactance/phase = sX_2

Rotor frequency = sf where E_2 , X_2 and f are the corresponding values at standstill.

Rotor Current:

Consider a 3-phase induction motor at any slip s . The rotor is assumed to be of wound type and star connected. Rotor e.m.f./phase and rotor reactance/phase are sE_2 and sX_2 respectively. The rotor resistance/phase is R_2 and is independent of frequency and, therefore, does not depend upon slip. Similarly stator winding values R_1 and X_1 do not depend upon slip.

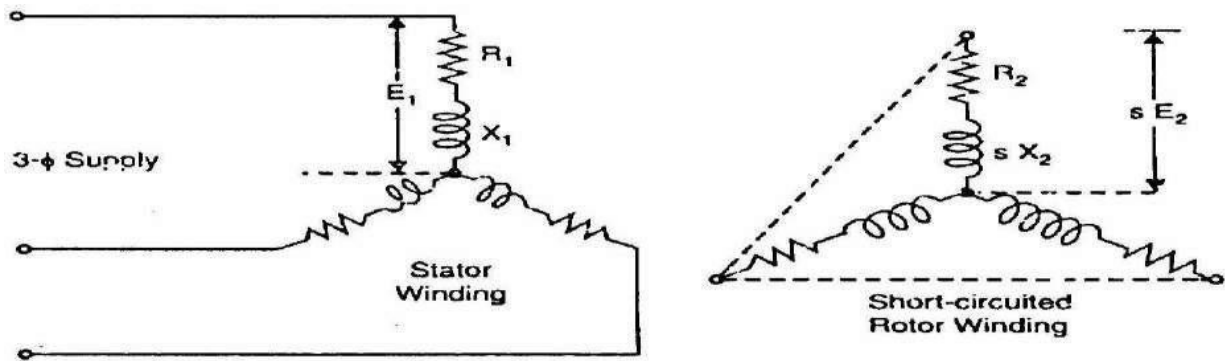

At standstill: One phase of the rotor circuit at standstill is shown in Fig: (i)

$$\text{Rotor current/phase, } I_2 = \frac{E_2}{Z_2} = \frac{E_2}{\sqrt{R_2^2 + X_2^2}}$$

$$\text{Rotor p.f., } \cos \phi_2 = \frac{R_2}{Z_2} = \frac{R_2}{\sqrt{R_2^2 + X_2^2}}$$

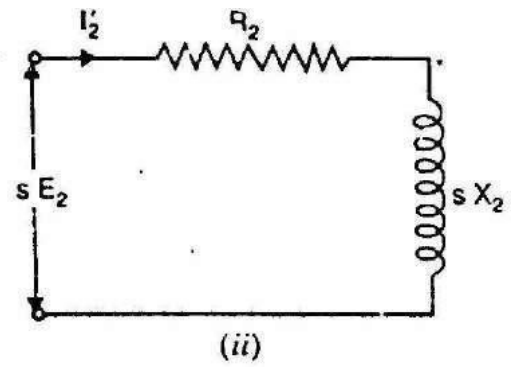
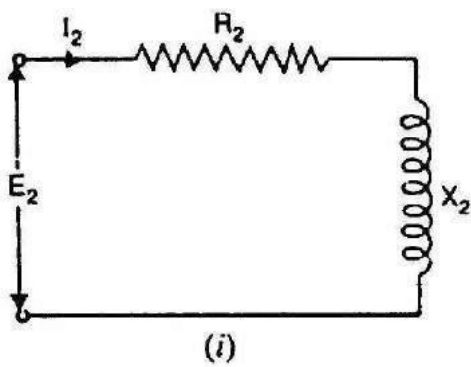

When running at slip s: Fig: (ii) shows one phase of the rotor circuit when the motor is running at slip s.

$$\text{Rotor current, } I'_2 = \frac{sE_2}{Z'_2} = \frac{sE_2}{\sqrt{R_2^2 + (sX_2)^2}}$$

$$\text{Rotor p.f., } \cos \phi'_2 = \frac{R_2}{Z'_2} = \frac{R_2}{\sqrt{R_2^2 + (sX_2)^2}}$$

Rotor Torque:

The torque T developed by the rotor is directly proportional to:

- i. rotor current
- ii. Rotor e.m.f.
- iii. power factor of the rotor circuit

$$\therefore T \propto E_2 I_2 \cos \phi_2$$

or $T = K E_2 I_2 \cos \phi_2$

where $I_2 =$ rotor current at standstill
 $E_2 =$ rotor e.m.f. at standstill
 $\cos \phi_2 =$ rotor p.f. at standstill

Starting Torque (T_{st}):

The torque developed by the motor at the instant of starting is called starting torque.

Let $E_2 =$ rotor e.m.f. per phase at standstill;

$R_2 =$ rotor resistance phase

$X_2 =$ rotor reactance phase at standstill

$$\therefore Z_2 = \sqrt{(R_2^2 + X_2^2)} = \text{rotor impedance/phase at } \textit{standstill}$$

Then, $I_2 = \frac{E_2}{Z_2} = \frac{E_2}{\sqrt{(R_2^2 + X_2^2)}}; \cos \phi_2 = \frac{R_2}{Z_2} = \frac{R_2}{\sqrt{(R_2^2 + X_2^2)}}$

Standstill or starting torque $T_{st} = k_1 E_2 I_2 \cos \phi_2$

or $T_{st} = k_1 E_2 \cdot \frac{E_2}{\sqrt{(R_2^2 + X_2^2)}} \times \frac{R_2}{\sqrt{(R_2^2 + X_2^2)}} = \frac{k_1 E_2^2 R_2}{R_2^2 + X_2^2}$

If supply voltage V is constant, then the flux Φ and hence, E_2 both are constant.

$$\therefore T_{st} = k_2 \frac{R_2}{R_2^2 + X_2^2} = k_2 \frac{R_2}{Z_2^2} \text{ where } k_2 \text{ is some other constant.}$$

Now, $k_1 = \frac{3}{2\pi N_s}, \therefore T_{st} = \frac{3}{2\pi N_s} \cdot \frac{E_2^2 R_2}{R_2^2 + X_2^2}$

Where $N_s \rightarrow$ synchronous speed in rps.

The magnitude of starting torque would depend upon the relative values of R_2 and X_2 i.e., rotor resistance/phase and standstill rotor reactance/phase. **Starting Torque of a Squirrel-cage Motor:**

- The resistance of a squirrel-cage motor is fixed and small as compared to its reactance which is very large especially at the start because at standstill, the frequency of the rotor currents equals the supply frequency. Hence, the starting current I_2 of the rotor, though very large in magnitude, lags by a very large angle behind E_2 with the result that the starting torque per ampere is very poor. □
- It is 1.5 times the full-load torque, although the starting current is 5 to 7 times the full-load current. Hence, such motors are not useful where the motor has to start against heavy loads. □

Starting Torque of a Slip-ring Motor:

- The starting torque of slip ring motor is increased by improving its power factor by adding external resistance in the rotor circuit from the star-connected rheostat, the rheostat resistance being progressively cut out as the motor gathers speed.□
- Addition of external resistance, however, increases the rotor impedance and so reduces the rotor current. At first, the effect of improved power factor predominates the current-decreasing effect of impedance. Hence, starting torque is increased. But after a certain point, the effect of increased impedance predominates the effect of improved power factor and so the torque starts decreasing.□

Condition for Maximum Starting Torque:

The starting torque will be maximum when rotor resistance/phase is equal to standstill rotor reactance/phase.

$$T_{st} = \frac{k_2 R_2}{R_2^2 + X_2^2}$$

Differentiating above equation w.r.t. R_2 and equating the result to zero, we get

$$\frac{dT_{st}}{dR_2} = k_2 \left[\frac{1}{R_2^2 + X_2^2} - \frac{R_2 (2R_2)}{(R_2^2 + X_2^2)^2} \right] = 0$$

$$R_2^2 + X_2^2 = 2R_2^2$$

$$\therefore R_2 = X_2$$

Hence starting torque will be maximum when:

Rotor resistance/phase = Standstill rotor reactance/phase

Under the condition of maximum starting torque, $\phi = 45^\circ$ and rotor power factor is 0.707 lagging.

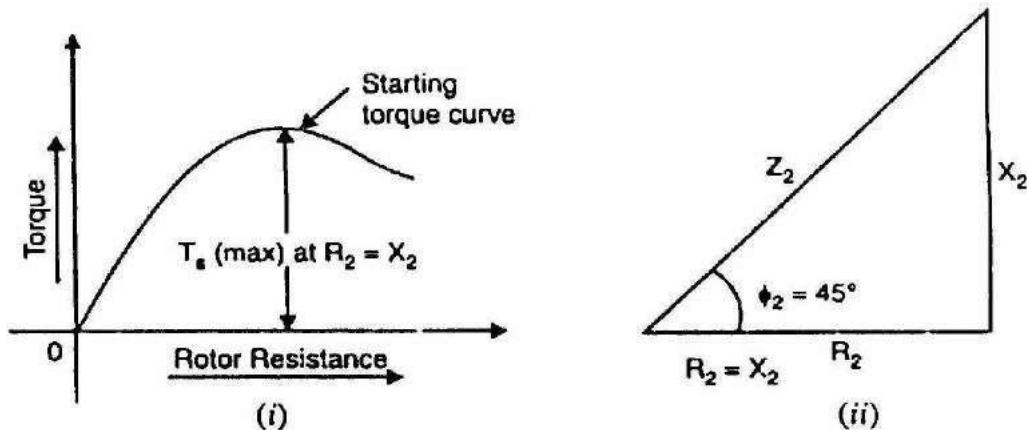

As the rotor resistance is increased from a low value, the starting torque increases until it becomes maximum when $R_2 = X_2$. If the rotor resistance is increased beyond this optimum value, the starting torque will decrease.

Effect of Change in Supply Voltage on Starting Torque:

$$T_{st} = \frac{k_1 E_2^2 R_2}{R_2^2 + X_2^2}$$

Since E_2 a Supply voltage V

$$T_{st} = \frac{k_3 V^2 R_2}{R_2^2 + X_2^2} = \frac{k_3 V^2 R_2}{Z_2^2}$$

where K_3 is another constant.

$$\text{Hence } T_{st} \propto V^2$$

Therefore, the starting torque is very sensitive to changes in the value of supply voltage. For example, a drop of 10% in supply voltage will decrease the starting torque by about 20%.

Torque Under Running Conditions:

Let the rotor at standstill have per phase induced e.m.f. E_2 , reactance X_2 and resistance R_2 .

$$T \propto E_r I_r \cos \phi_2 \text{ or } T \propto \phi I_r \cos \phi_2$$

where $E_r =$ rotor e.m.f./phase under *running conditions*
 $I_r =$ rotor current/phase under *running conditions*

Now $E_r = sE_2$

$$\therefore I_r = \frac{E_r}{Z_r} = \frac{sE_2}{\sqrt{[R_2^2 + (sX_2)^2]}}$$

$$\cos \phi_2 = \frac{R_2}{\sqrt{[R_2^2 + (sX_2)^2]}}$$

$$\therefore T \propto \frac{s \Phi E_2 R_2}{R_2^2 + (sX_2)^2} = \frac{k \Phi \cdot s \cdot E_2 R_2}{R_2^2 + (sX_2)^2}$$

$$\text{Also } T = \frac{k_1 \cdot s E_2^2 R_2}{R_2^2 + (sX_2)^2} \quad (\because E_2 \propto \phi)$$

Where k_1 is another constant. Its value is equal to $\frac{3}{2\pi N_s}$

$$T = \frac{3}{2\pi N_s} \cdot \frac{s E_2^2 R_2}{R_2^2 + (sX_2)^2} = \frac{3}{2\pi N_s} \cdot \frac{s E_2^2 R_2}{Z_r^2}$$

At standstill when $s=1$,

$$T_{st} = \frac{k_1 E_2^2 R_2}{R_2^2 + X_2^2} \left(\text{or } = \frac{3}{2\pi N_s} \cdot \frac{E_2^2 R_2}{R_2^2 + X_2^2} \right)$$

It may be seen that running torque is:

- i. Directly proportional to slip i.e., if slip increases (i.e., motor speed decreases), the torque will increase and vice-versa.
- ii. Directly proportional to square of supply voltage (E_2 a V)

Maximum Torque under Running Conditions:

The torque of a rotor under running conditions is

$$T = \frac{k\Phi s E_2 R_2}{R_2^2 + (sX_2)^2} = k_1 \frac{s E_2^2 R_2}{R_2^2 + (sX_2)^2}$$

The condition for maximum torque may be obtained by differentiating the above expression with respect to slip s and then putting it equal to zero.

$$\begin{aligned} \frac{dT}{ds} &= \frac{K_1 \left[R_2 (R_2^2 + s^2 X_2^2) - 2s X_2^2 (s R_2) \right]}{(R_2^2 + s^2 X_2^2)^2} = 0 \\ (R_2^2 + s^2 X_2^2) - 2s X_2^2 &= 0 \\ R_2^2 &= s^2 X_2^2 \\ R_2 &= s X_2 \end{aligned}$$

Thus for maximum torque (T_m) under running conditions:

Rotor resistance/phase = Fractional slip \times Standstill rotor reactance/phase

Slip corresponding to maximum torque is $s = R_2/X_2$

Putting $R_2 = sX_2$ and Substituting value of $s = R_2/X_2$ in the torque equation

$$T_{\max} = k_1 \frac{(R_2/X_2) \cdot E_2^2 \cdot R_2}{R_2^2 + (R_2/X_2)^2 \cdot X_2^2} = k_1 \frac{E_2^2}{2 X_2}$$

$$T_{\max} = \frac{3}{2\pi N_s} \cdot \frac{E_2^2}{2X_2} \text{ N}\cdot\text{m}$$

From the above, it is found that

- i. The maximum torque is independent of rotor resistance.
- ii. However, the speed or slip at which maximum torque occurs is determined by the rotor resistance. torque becomes maximum when rotor reactance equals its resistance. Hence, by varying rotor resistance (possible only with slip-ring motors) maximum torque can be made to occur at any desired slip (or motor speed),
- iii. Maximum torque varies inversely as standstill reactance. Hence, it should be kept as small as possible.
- iv. Maximum torque varies directly as the square of the applied voltage.
- v. For obtaining maximum torque at starting ($s = 1$), rotor resistance must be equal to rotor reactance.

Torque-Slip Characteristics:

The graph drawn between the torque and slip for a particular value of rotor resistance R_2 , is called torque-slip characteristic. A family of torque-slip characteristics for a slip-range from $s = 0$ to $s = 1$ for various values of rotor resistance is shown below.

The motor torque under running conditions is given by

$$T = \frac{k \Phi s E_2 R_2}{R_2^2 + (s X_2)^2}$$

$$T \propto \frac{s R_2}{R_2^2 + s^2 X_2^2}$$

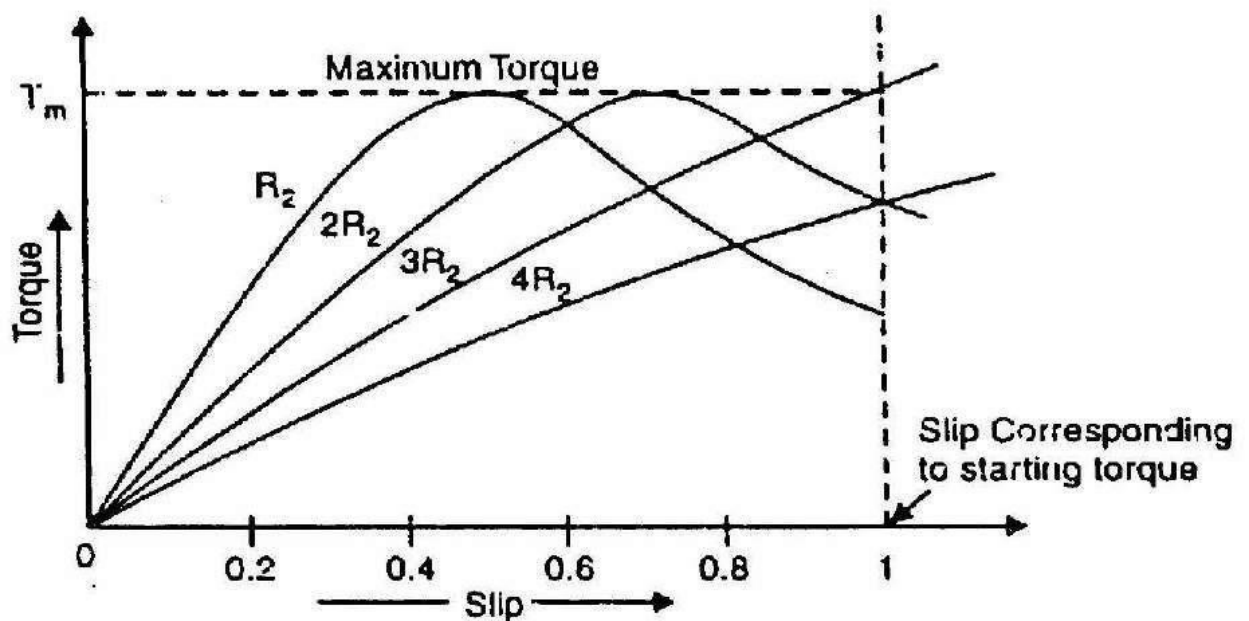

- (i) At $s = 0$, $T = 0$ so that torque-slip curve starts from the origin.
- (ii) At normal speed, slip is small so that $s X_2$ is negligible as compared to R_2 .

$$T \propto \frac{s}{R_2}$$

$\propto s$... as R_2 is constant

Hence torque slip curve is a straight line from zero slip to a slip that corresponds to full-load.

- (iii) As slip increases beyond full-load slip, the torque increases and becomes maximum at $s = \frac{R_2}{X_2}$. This maximum torque in an induction motor is called pull-out torque or break-down torque. Its value is at least twice the full-load value when the motor is operated at rated voltage and frequency.

- (iv) When slip increases beyond that corresponding to maximum torque, the term $s^2 X_2^2$ increases very rapidly so that R_2^2 may be neglected as compared to $s^2 X_2^2$.

$$T \propto \frac{s}{s^2 X_2^2}$$

$$\propto \frac{1}{s} \quad \dots \quad \text{as } X_2 \text{ is constant}$$

Thus the torque is now inversely proportional to slip. Hence torque-slip curve is a rectangular hyperbola.

- (v) The maximum torque remains the same and is independent of the value of rotor resistance. Therefore, the addition of resistance to the rotor circuit does not change the value of maximum torque but it only changes the value of slip at which maximum torque occurs.

Full-Load and Maximum Torque:

Let s_f be the slip corresponding to full-load Torque

$$T_f \propto \frac{s_f R_2}{R_2^2 + (s_f X_2)^2}$$

$$T_{\max} \propto \frac{1}{2 X_2}$$

$$\frac{T_f}{T_{\max}} = \frac{2s_f R_2 X_2}{R_2^2 + (s_f X_2)^2}$$

Dividing the numerator and denominator on R.H.S. by X_2 , we get,

$$\frac{T_f}{T_{\max}} = \frac{2s_f \cdot R_2 / X_2}{(R_2 / X_2)^2 + s_f^2} = \frac{2as_f}{a^2 + s_f^2}$$

$$\text{where } a = \frac{R_2}{X_2} = \frac{\text{Rotor resistance/phase}}{\text{Standstill rotor reactance/phase}}$$

Starting Torque Maximum Torque:

$$T_{st} \propto \frac{R_2}{R_2^2 + X_2^2}$$

$$T_{\max} \propto \frac{1}{2 X_2}$$

Dividing the numerator and denominator on R.H.S. by X_2 , we get,

$$\frac{T_{st}}{T_{\max}} = \frac{2R_2 X_2}{R_2^2 + X_2^2} = \frac{2R_2 / X_2}{1 + (R_2 / X_2)^2} = \frac{2a}{1 + a^2}$$

$$\text{where } a = \frac{R_2}{X_2} = \frac{\text{Rotor resistance/phase}}{\text{Standstill rotor reactance/phase}}$$

Power Stages in an Induction Motor:

The input electric power fed to the stator of the motor is converted into mechanical power at the shaft of the motor. The various losses during the energy conversion are:

1. Fixed losses
 - (i) Stator iron loss
 - (ii) Friction and windage loss

The rotor iron loss is negligible because the frequency of rotor currents under normal running condition is small.

2. Variable losses
 - (i) Stator copper loss
 - (ii) Rotor copper loss

Fig. shown below shows electric power fed to the stator of an induction motor suffers losses and finally converted into mechanical power.

From the figure the following points may be noted:

- (i) Stator input, $P_i = \text{Stator output} + \text{Stator losses}$
 $= \text{Stator output} + \text{Stator Iron loss} + \text{Stator Cu loss}$
- (ii) Rotor input, $P_r = \text{Stator output}$
 It is because stator output is entirely transferred to the rotor through air-gap by electromagnetic induction.
- (iii) Mechanical power available, $P_m = P_r - \text{Rotor Cu loss}$
 This mechanical power available is the gross rotor output and will produce a gross torque T_g .
- (iv) Mechanical power at shaft, $P_{out} = P_m - \text{Friction and windage loss}$
 Mechanical power available at the shaft produces a shaft torque T_{sh} . Clearly, $P_m - P_{out} = \text{Friction and windage loss}$

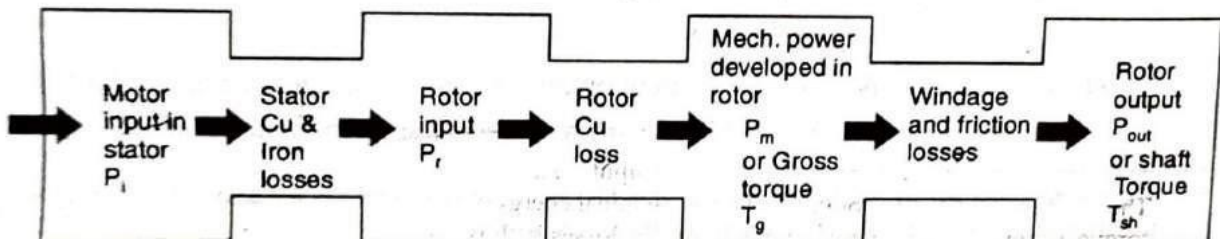

Induction Motor Torque:

The mechanical power P available from any electric motor can be expressed as:

$$P = \frac{2\pi NT}{60} \text{ watts}$$

Where N = speed of the motor in r.p.m.

T = torque developed in N-m

If the gross output of the rotor of an induction motor is P_m and its speed is N r.p.m., then gross torque T_g developed is given by:

$$T_g = 9.55 \frac{P_m}{N} \text{ N-m}$$

Similarly

$$T_{sh} = 9.55 \frac{P_{out}}{N} \text{ N - m}$$

Rotor Output:

If T_g newton-metre is the gross torque developed and N r.p.m. is the speed of the rotor, then,

$$\text{Gross rotor output} = P = \frac{2\pi NT_g}{60} \text{ watts}$$

If there were no copper losses in the rotor, the output would equal rotor input and the rotor would run at synchronous speed N_s .

$$\therefore \text{Rotor input} = \frac{2\pi N_s T_g}{60} \text{ watts}$$

$$\begin{aligned} \therefore \text{Rotor Cu loss} &= \text{Rotor input} - \text{Rotor output} \\ &= \frac{2\pi T_g}{60} (N_s - N) \end{aligned}$$

$$(i) \quad \frac{\text{Rotor Cu loss}}{\text{Rotor input}} = \frac{N_s - N}{N_s} = s$$

$$\therefore \text{Rotor Cu loss} = s \times \text{Rotor input}$$

$$(ii) \quad \begin{aligned} \text{Gross rotor output, } P_m &= \text{Rotor input} - \text{Rotor Cu loss} \\ &= \text{Rotor input} - s \times \text{Rotor input} \end{aligned}$$

$$\therefore P_m = \text{Rotor input} (1 - s)$$

$$(iii) \quad \frac{\text{Gross rotor output}}{\text{Rotor input}} = 1 - s = \frac{N}{N_s}$$

$$(iv) \quad \frac{\text{Rotor Cu loss}}{\text{Gross rotor output}} = \frac{s}{1 - s}$$

It is clear that if the input power to rotor is P_r , then sP_r is lost as rotor Cu loss and the remaining $(1 - s)P_r$ is converted into mechanical power. Consequently, induction motor operating at high slip has poor efficiency.

Note: Rotor input: Rotor Cu loss: Gross rotor output = 1: s: (1-s)

$$\frac{\text{Gross rotor output}(P_m)}{\text{Rotor input}(P_r)} = 1 - s = \frac{N}{N_s}$$

If the stator losses as well as friction and windage losses are neglected, then,

$$\text{Gross rotor output} = \text{Useful output}$$

$$\text{Rotor input} = \text{Stator input}$$

$$\therefore \frac{\text{Useful output}}{\text{Stator output}} = 1 - s = \text{Efficiency}$$

Starting of Three Phase Induction Motor:

When the supply is connected to the stator of a three-phase induction motor, a rotating magnetic field is produced and the rotor starts rotating. Thus a three phase Induction motor is self-starting.

The induction motor is fundamentally a transformer in which the stator is the primary and the rotor is short-circuited secondary. At starting, the voltage induced in the induction motor rotor is maximum ($s = 1$). Since the rotor impedance is low, the rotor current is very large. This large rotor current is reflected in the stator because of transformer action. This results in high starting current (4 to 10 times the full-load current) in the stator at low power factor and consequently the value of starting torque is low. Because of the short duration, this value of large current does not harm the motor if the motor accelerates normally.

However, this large starting current will produce large line-voltage drop. This will affect the operation of other electrical equipment connected to the same lines. Therefore, it is desirable and necessary to reduce the magnitude of stator current at starting. Thus the purpose of a starter is not to start the motor but to limit the heavy starting current of the motor at the time of starting.

Methods of Starting Three Phase Induction Motors:

The method to be employed in starting a given induction motor depends upon the size of the motor and the type of the motor. The methods used to start induction motors are:

- (i) Direct-on-line starting
- (ii) Stator resistance starting (iii) Autotransformer starting
- (iv) Star-delta starting
- (v) Rotor resistance starting

Methods (i) to (iv) are applicable to both squirrel-cage and slip ring motors. However, method (v) is applicable only to slip ring motors.

Except direct-on-line starting, all other methods of starting squirrel-cage motors employ reduced voltage across motor terminals at starting.

Direct-on-line starting:

In this method of starting the motor is started by connecting it directly to 3-phase supply. The impedance of the motor at standstill is relatively low and when it is directly connected to the supply system, the starting current will be high (4 to 10 times the full-load current) and at a low power factor. Consequently, this method of starting is suitable for relatively small (up to 7.5 kW) machines.

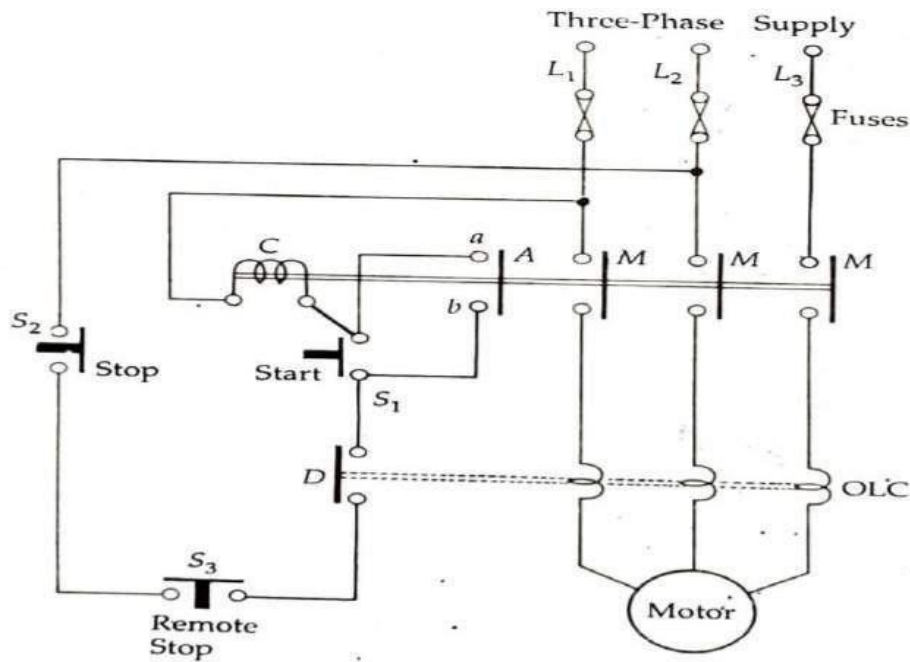

D.O.L starter consists of a coil-operated contactor C controlled by start and stop push buttons which may be installed at convenient places remote from the starter. On pressing the START push button S_1 , (which is normally held open by a spring) the contactor coil C is energised from two line conductors L_1 and L_2 . The three main contacts M and the auxiliary contact A close and the terminals a and b are short-circuited. The motor is thus connected to the supply. When the pressure on S_1 is released, it moves back under spring action. Even then the coil C remains energised through ab. Thus, the main contacts M remain closed and the motor continues to get supply. For this reason, contact A is called hold-on-contact.

When the STOP push button S_2 (which is normally held closed by spring) is pressed, the supply through the contactor coil C is disconnected. Since the coil C is de-energised, the main contacts M and auxiliary contact A are opened. The supply to motor is disconnected and the motor stops.

- When the voltage falls below a certain value, or in the event of failure of supply during motor operation, the coil C is de-energised. The motor is then disconnected from the supply.
- In case of an overload on the motor, one or all the overload coils (O.L.C) are energised. The normally closed contact D is opened and the contactor coil C is de-energised to disconnect the supply to the motor.

Fuses are provided in the circuit for short-circuit protection.

Direct-on-line starting is a simple and cheap method. The starting current be as large as 10 times the full load current and the starting torque is equal to full-load torque. Such a large starting current produces excessive voltage droop in the line supplying the motor. Small motors up to 5kW rating may be started by D.O.L. starters to avoid supply voltage fluctuations.

Relation between starting and F.L. torques. We know that:

$$\text{Rotor input} = 2\pi N_s T = kT$$

But Rotor Cu loss = $s \times$ Rotor input

$$\therefore 3(I_2)^2 R_2 = s \times kT$$

or $T \propto (I_2)^2 / s$

or $T \propto I_1^2 / s$ ($\because I_2 \propto I_1$)

If I_{st} is the starting current, then starting torque (T_{st}) is

$$T \propto I_{st}^2 \quad (\because \text{at starting } s = 1)$$

If I_f is the full-load current and s_f is the full-load slip, then,

$$T_f \propto I_f^2 / s_f$$

$$\therefore \frac{T_{st}}{T_f} = \left(\frac{I_{st}}{I_f} \right)^2 \times s_f$$

When the motor is started direct-on-line, the starting current is the short-circuit (blocked-rotor) current I_{sc} .

$$\therefore \frac{T_{st}}{T_f} = \left(\frac{I_{sc}}{I_f} \right)^2 \times s_f$$

Note that starting current is as large as five times the full-load current but starting torque is just equal to the full-load torque. Therefore, starting current is very high and the starting torque is comparatively low. If this large starting current flows for a long time, it may overheat the motor and damage the insulation.

Stator resistance starting:

In this method, external resistances are connected in series with each phase of stator winding during starting. This causes voltage drop across the resistances so that voltage available across motor terminals is reduced and hence the starting current. The starting resistances are gradually cut out in steps (two or more steps) from the stator circuit as the motor picks up speed. When the motor attains rated speed, the resistances are completely cut out and full line voltage is applied to the rotor.

Drawback:

- First, the reduced voltage applied to the motor during the starting period lowers the starting torque and hence increases the accelerating time.
- Secondly, a lot of power is wasted in the starting resistances.

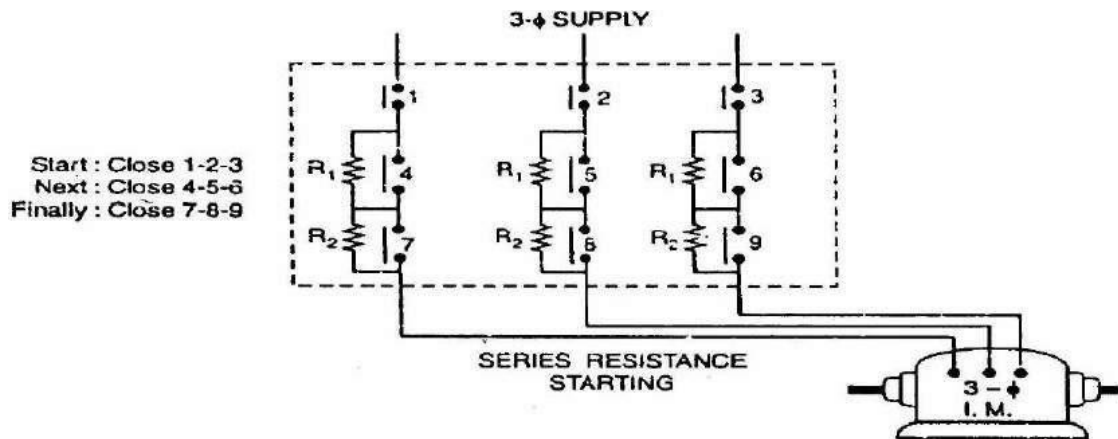

Relation between starting and F.L. torques.

Let V be the rated voltage/phase. If the voltage is reduced by a fraction x by the insertion of resistors in the line, then voltage applied to the motor per phase will be xV .

So,

$$I_{st} = x I_{sc}$$

Now
$$\frac{T_{st}}{T_f} = \left(\frac{I_{st}}{I_f}\right)^2 \times S_f$$

or
$$\frac{T_{st}}{T_f} = x^2 \left(\frac{I_{sc}}{I_f}\right)^2 \times S_f$$

Thus while the starting current reduces by a fraction x of the rated-voltage starting current (I_{sc}), the starting torque is reduced by a fraction x^2 of that obtained by direct switching. The reduced voltage applied to the motor during the starting period lowers the starting current but at the same time increases the accelerating time because of the reduced value of the starting torque. Therefore, this method is used for starting small motors only.

Autotransformer starting:

This method also aims at connecting the induction motor to a reduced supply at starting and then connecting it to the full voltage as the motor picks up sufficient speed. The tapping on the autotransformer is so set that when it is in the circuit, 65% to 80% of line voltage is applied to the motor.

At the instant of starting, the change-over switch is thrown to "start" position. This puts the autotransformer in the circuit and thus reduced voltage is applied to the circuit. Consequently, starting current is limited to safe value. When the motor attains about 80% of normal speed, the changeover switch is thrown to "run" position. This takes out the autotransformer from the circuit and puts the motor to full line voltage.

Advantages of Autotransformer starting:

- (i) low power loss, (ii) low starting current and (iii) less radiated heat.

For large machines (over 25 H.P.), this method of starting is often used. This method can be used for both star and delta connected motors.

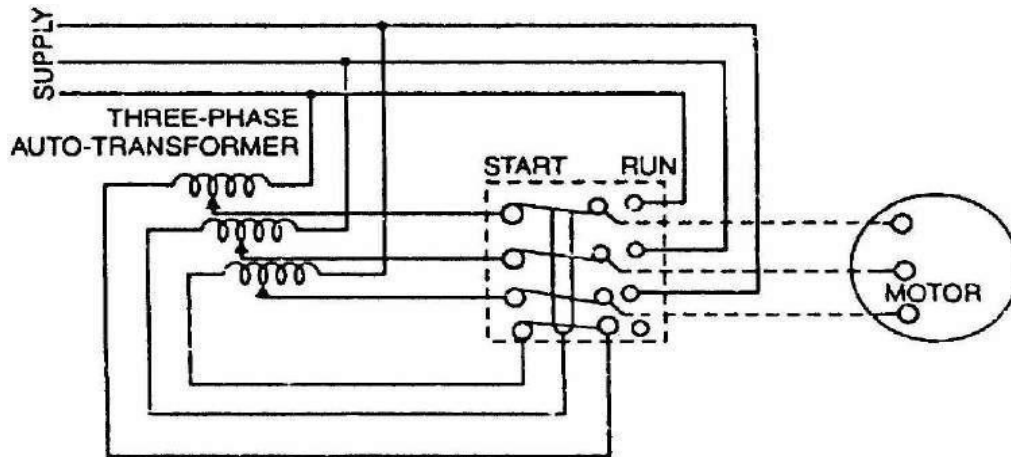

Relation between starting And F.L. torques. Consider a star-connected squirrel-cage induction motor. If V is the line voltage, then voltage across motor phase on direct switching is $V/\sqrt{3}$ and starting current is $I_{st} = I_{sc}$. In case of autotransformer, if a tapping of transformation ratio K (a fraction) is used, then phase voltage across motor is $KV/\sqrt{3}$ and $I_{st} = K I_{sc}$.

$$\text{Now } \frac{T_{st}}{T_f} = \left(\frac{I_{st}}{I_f}\right)^2 \times s_f = \left(\frac{K I_{sc}}{I_f}\right)^2 \times s_f = K^2 \left(\frac{I_{sc}}{I_f}\right)^2 \times s_f$$

$$\therefore \frac{T_{st}}{T_f} = K^2 \left(\frac{I_{sc}}{I_f}\right)^2 \times s_f$$

The current taken from the supply or by autotransformer is $I_1 = K I_2 = K^2 I_{sc}$.

The motor current is K times, the supply line current is K^2 times and the starting torque is K^2 times the value it would have been on direct-on-line starting.

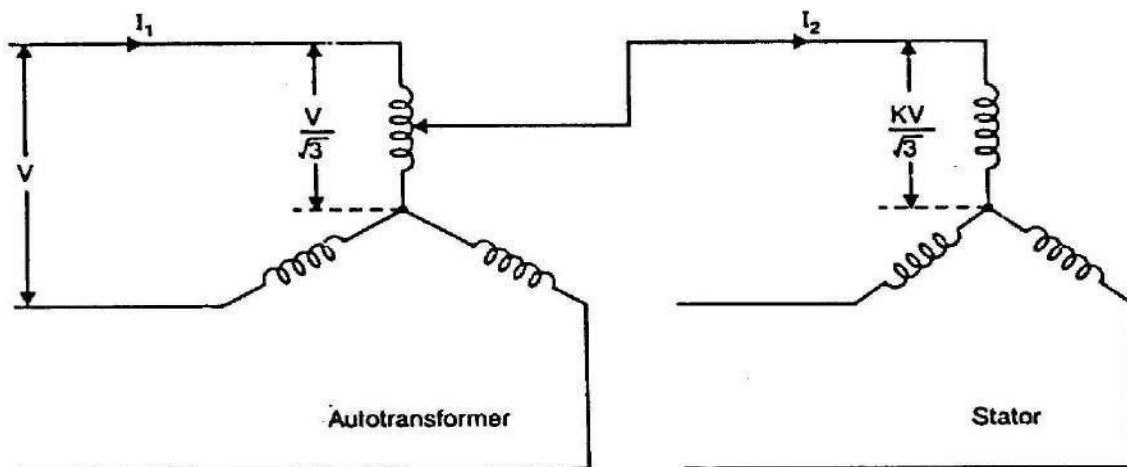

Star-delta starting:

The stator winding of the motor is designed for delta operation and is connected in star during the starting period. When the machine is up to speed, the connections are changed to delta.

The six leads of the stator windings are connected to the changeover switch as shown in figure below. At the instant of starting, the changeover switch is thrown to "Start" position which connects the stator windings in star. Therefore, each stator phase gets $V/\sqrt{3}$ volts where V is the line voltage. This reduces the starting current. When the motor picks up speed, the changeover switch is thrown to "Run" position which connects the stator windings in delta. Now each stator phase gets full line voltage V .

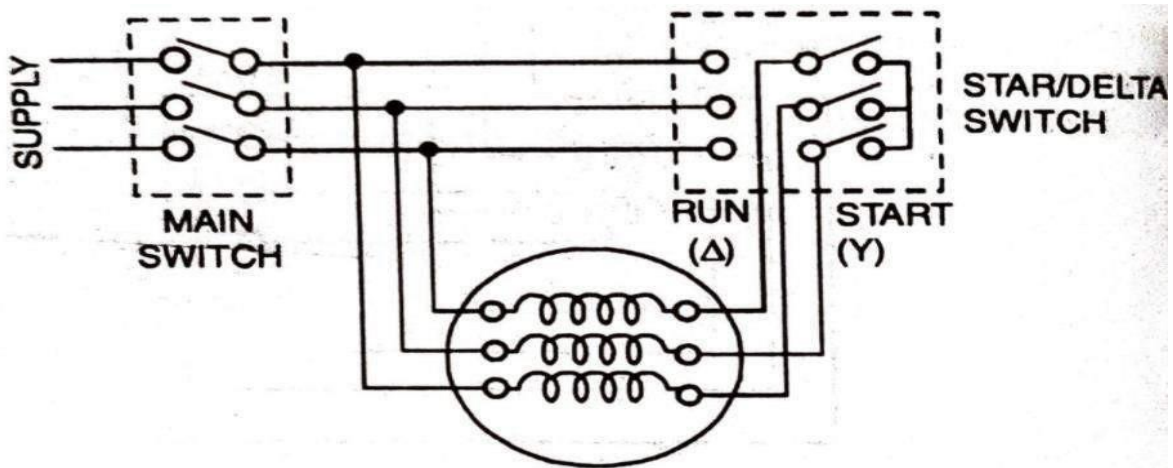

Disadvantages of this method are:

- a) With star-connection during starting, stator phase voltage is $\frac{1}{\sqrt{3}}$ times the line voltage.

2

Consequently, starting torque is $(\frac{1}{\sqrt{3}})^2$ or $\frac{1}{3}$ times the value it would

have with Delta- connection. This is a large reduction in starting torque.

- b) The reduction in voltage is fixed.

This method of starting is used for medium-size machines (up to about 25 H.P)

Relation between starting and F.L. torques. In direct delta starting,

Starting current/phase, $I_{sc} = V/Z_{sc}$ where V = line voltage

Starting line current = $\sqrt{3} I_{sc}$

In star starting, we have,

Starting current/phase, $I_{st} = \frac{V/\sqrt{3}}{Z_{sc}} = \frac{1}{\sqrt{3}} I_{sc}$

Now
$$\frac{T_{st}}{T_f} = \left(\frac{I_{st}}{I_f} \right)^2 \times s_f = \left(\frac{I_{sc}}{\sqrt{3} \times I_f} \right)^2 \times s_f$$

or
$$\frac{T_{st}}{T_f} = \frac{1}{3} \left(\frac{I_{sc}}{I_f} \right)^2 \times S_f$$

where I_{sc} = starting phase current (delta)
 I_f = F.L. phase current (delta)

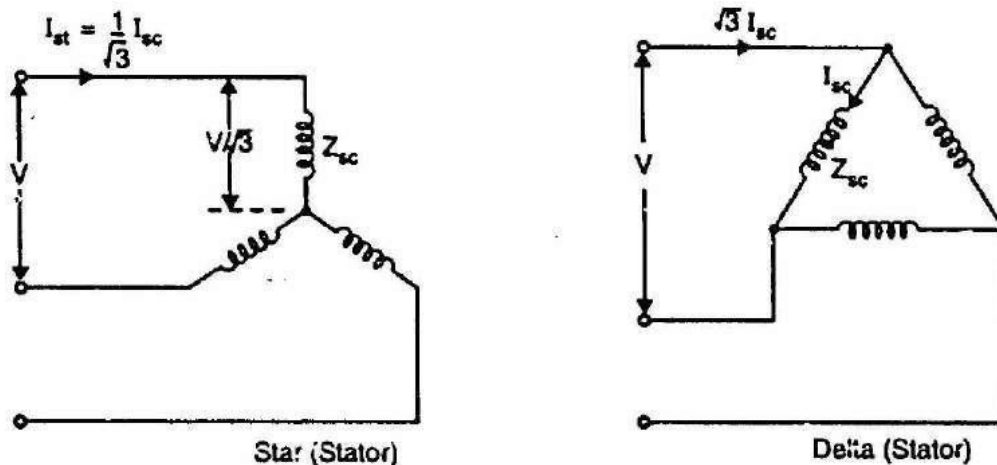

In star-delta starting, the starting line current is reduced to one-third as compared to starting with the winding delta connected. Further, starting torque is reduced to one-third of that obtainable by direct delta starting. This method is cheap but limited to applications where high starting torque is not necessary e.g., machine tools, pumps etc.

Rotor resistance starting:

Slip-ring motors are invariably started by rotor resistance starting. In this method, a variable star-connected rheostat is connected in the rotor circuit through slip rings and full voltage is applied to the stator winding as shown in Fig.

- i. At starting, the handle of rheostat is set in the OFF position so that maximum resistance is placed in each phase of the rotor circuit. This reduces the starting current and at the same time starting torque is increased.
- ii. As the motor picks up speed, the handle of rheostat is gradually moved in clockwise direction and cuts out the external resistance in each phase of the rotor circuit. When the motor attains normal speed, the change-over switch is in the ON position and the whole external resistance is cut out from the rotor circuit.

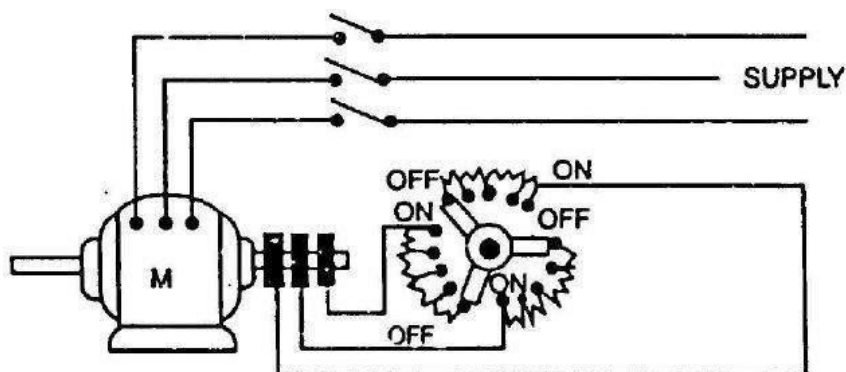

Speed Control of Induction Motors:

The slip of an induction motor is very small (< 3%) so that it is essentially a "constant-speed motor. Therefore, it is suitable for use in essentially constant-speed drive systems. The speed of an induction motor can be changed by the following methods:

1. By changing the number of stator poles (P).
2. By changing the line frequency
3. By changing the applied voltage.
4. By changing resistance in the rotor circuit.

Speed Control by changing number of stator poles:

We know that synchronous speed of induction motor $N_s = \frac{120f}{P}$. Therefore, by changing the number of stator poles (P), the synchronous speed and hence the rotor speed (N) can be changed. This method is easily applicable to squirrel cage motors but is not practicable for wound rotor motors. Squirrel cage motors designed for pole-changing control are commonly called multispeed motors.

Speed Control by changing Line frequency:

We know that synchronous speed of an induction motor is given by $N_s = \frac{120f}{P}$. Therefore, by changing the line frequency f, the synchronous speed (N_s) of the motor and hence the running speed (N) can be changed.

When employing line-frequency control, the applied line voltage should be changed in direct proportion to the frequency i.e. if frequency is increased, the supply voltage must also be increased and if the frequency is decreased, the supply voltage must also be decreased proportionately. This is necessary to maintain an approximately constant flux in the air-gap of the machine, otherwise the motor performance will not be satisfactory. Under these conditions, the maximum developed torque will remain approximately constant and the output power will vary approximately in direct proportion to the speed of the motor.

Disadvantages:

It involves the use of 3-phase variable frequency power supply. The auxiliary equipment required for this purpose results in a high first cost, increased maintenance and lowering of the overall efficiency.

Speed Control by changing applied Voltage:

We know that torque developed (T) by an induction motor is directly proportional to the square of applied voltage (V) i.e $T \propto V^2$. Therefore, by changing the applied voltage, the

torque and hence speed (or slip) of the motor can be changed. Fig. shown below shows the arrangement to control the speed of induction motor (squirrel cage or wound rotor motor) by changing the applied voltage.

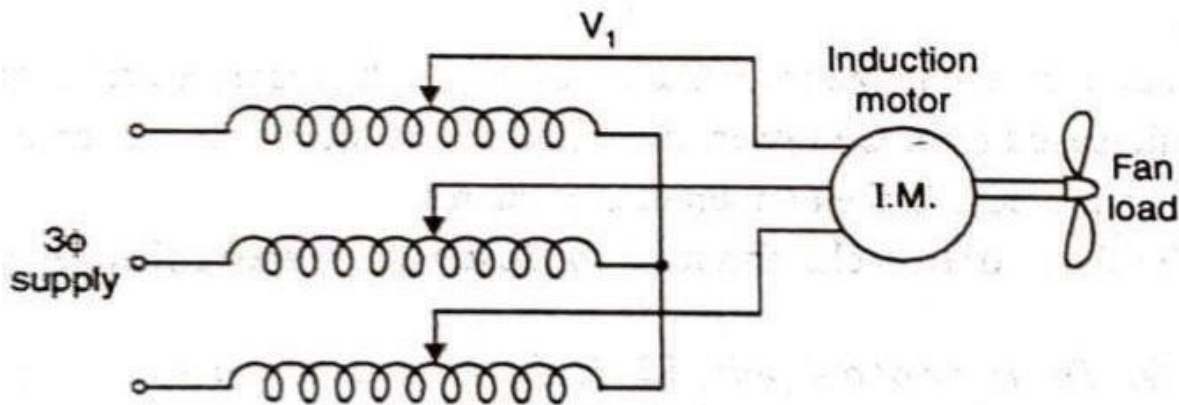

The motor is supplied from 3-phase Supply through a 3-phase autotransformer. The motor drives fan load. The voltage applied to the motor can be changed by the autotransformer and hence desired motor speed can be obtained. when we change the applied voltage, the slip (s) of the motor is changed i.e. motor speed changes.

Limitations: The stator voltage control method is the cheapest and the easiest method of speed control of induction motors. However, it is rarely used because of the following drawbacks

- i. A large change in voltage is required for a relatively small change in speed.
- ii. The large change in voltage results in large change in the flux density. This affects the magnetic conditions and hence performance of the motor.

Speed Control by changing Rotor circuit Resistance

This method of speed control is suitable only for slip- ring motors. The speed of the motor can be decreased by adding external resistance to the rotor. Under normal running condition, the relation between torque (T) and slip (s) of an induction motor is given by:

$$T \propto \frac{s}{R_2}$$

where R_2 is the rotor resistance/phase.

From the above relation, for a given torque, $s \propto R_2$. Therefore slip can be increased (i.e. motor speed can be decreased) by increasing the rotor resistance.

Drawbacks:

- i. There is an increase in the rotor Cu losses due to the increased rotor circuit resistance.
- ii. Due to increased rotor Cu losses, the efficiency of the motor is decreased. iii. There is an increase in the temperature of the motor.

Because of the above drawbacks, this method is used where speed changes are required for short periods only.

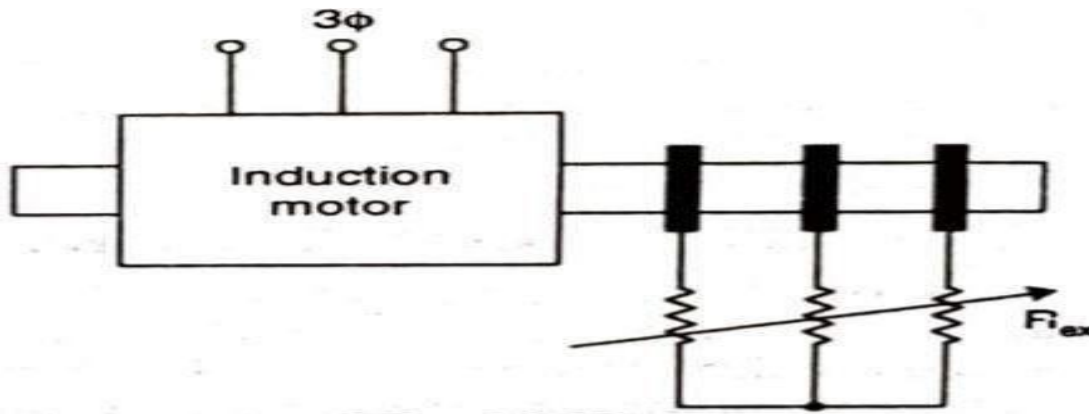

Plugging of an Induction motor:

- To bring the running Induction motor to a rapid stop, the two stator leads can be simply interchanged. This process is called plugging.□
- When we interchange two stator leads, the revolving field suddenly turns in the opposite direction to the rotor. During the plugging period, the motor acts as a brake. It absorbs kinetic energy from the still-revolving field, causing its speed to fall.□
- The mechanical power associated with the rotor is entirely dissipated as heat in the rotor. At the same time rotor also continues to receive power from the stator which is also dissipated as heat. Consequently, plugging produces I^2R losses in the rotor which even exceed those when the rotor is locked.□
- Motors should not be plugged too frequently because high rotor temperatures may melt the rotor bars or overheat the stator winding. When very high inertia loads have to be brought to a stop, wound-rotor motors are recommended because most of the thermal energy absorbed by the rotor is dissipated by the external resistors. Furthermore, we can maintain a consistently high torque by gradually varying the rotor resistance during deceleration period.□

Induction Generator:

If an induction motor whose stator windings are connected to a 3-phase line is driven by a mover prime- at a speed higher than synchronous speed, it acts as a generator. It converts the mechanical energy it receives from the prime-mover into electrical energy and this electrical energy is supplied to the mains. Such a machine is called an induction generator or asynchronous generator.

When of speed the induction motor exceeds the synchronous speed, the slip (s) becomes negative. Therefore, the relative motion between rotor conductors and the rotating flux is reversed and as a result, the directions of rotor e.m.f. and the rotor currents will also be reversed. However, as soon as this takes place, the motor develops a counter torque which opposes the increase in speed. Thus generator operation occurs and mechanical energy of the prime-mover is converted into electrical energy which is supplied to the mains.

Figure shown below shows an induction generator connected to a 3-phase line. The petrol engine is the prime-mover. As the engine speed exceeds the synchronous speed, the motor

becomes a generator, delivering active power P (kW) to the electrical systems (i.e. 3-phase which line in this case) to it is connected. However, to create its magnetic field, the motor has to absorb reactive power Q (kVAR). This power can only come from the supply lines. Consequently, the reactive power Q flows in the opposite direction to the active power P .

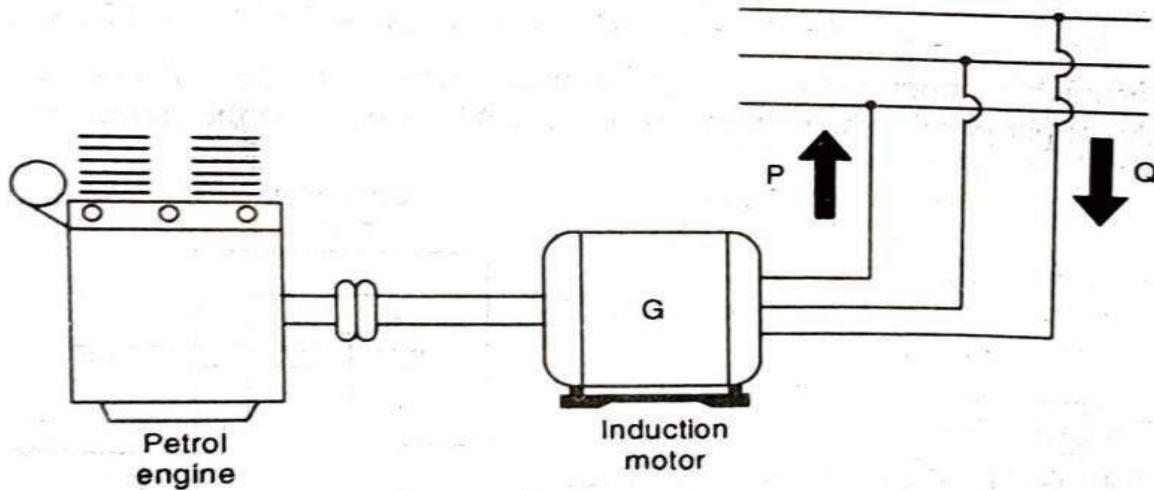

The active power P (kW) delivered is directly proportional to the slip above synchronous speed. Thus, a higher engine speed produces a greater output. However, the rated output is reached at small slip, generally less than 3%.

An Induction generator will deliver power only if it is supplied with proper reactive power to create its magnetic field. For this reason, an induction generator is generally connected to a 3-phase line. The reactive power may be supplied by a group of capacitors connected to the terminals of the motor.

The terminal voltage increases with the capacitance, but its magnitude is limited by saturation in the iron. If the capacitance is insufficient, the generator voltage will not build up. The capacitor bank must be large enough to supply the reactive power the machine normally absorbs when operating as a motor.

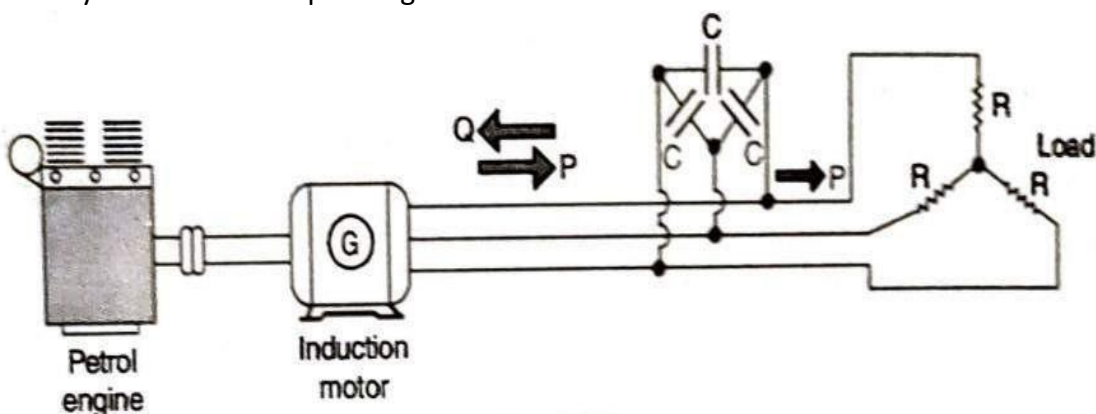

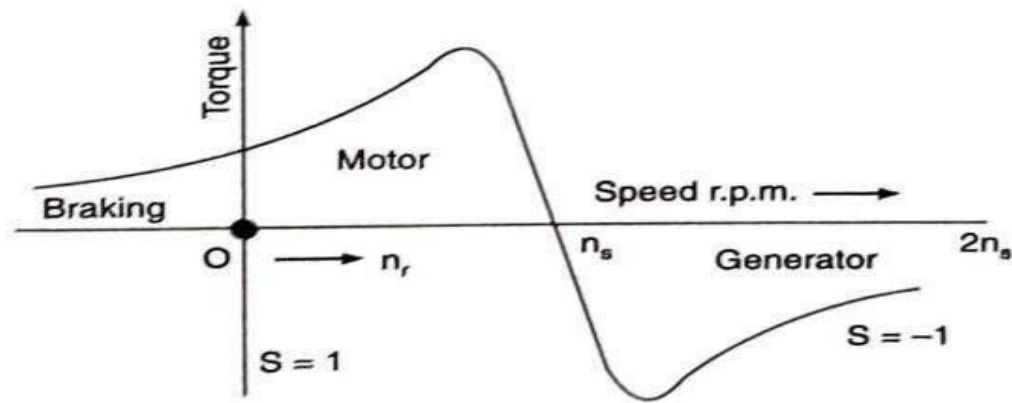

Torque-speed curve of induction machine showing braking, motoring and generating regions.

Applications of Induction Generators:

The induction generator is not a self-excited generator. It is necessary to excite the stator with an external polyphase source at its rated voltage and frequency. It will generate only when it is connected to a source of fixed voltage and frequency and if it is then driven at a speed above the synchronous speed.

Thus the induction or asynchronous generator has limited applications. The most important use of the principle of the Induction generator lies in automatic dynamic braking. For example, in a lift or crane driven by an induction motor, when the laden cage or hook is descending, the load torque on the motor acts in the direction of rotation. As a result, the motor speed exceeds the synchronous speed and the machine automatically becomes an induction generator and produces a braking torque, returning the energy of the descending load to the supply.

Cogging in 3-phase Induction Motor:

A squirrel-cage rotor may show a peculiar behaviour in starting for certain relationship between the number of stator slots (S_1) and rotor slots (S_2). If S_1 is equal to or an integral multiple of S_2 , the motor may refuse to start. This phenomenon is known as cogging and is due to the magnetic locking between the stator and rotor teeth.

The reluctance of the magnetic path depends upon the positions of rotor teeth w.r.t. stator teeth. The reluctance of the magnetic path is minimum when the rotor and stator teeth face each other. In such positions of minimum reluctance, there exists a strong alignment force between the stator and the rotor at standstill. The alignment force at the instant of start may become stronger than the starting torque. Consequently, the motor fails to start. To avoid cogging, the number of stator and rotor slots are never made to be equal or have an integral ratio.

Crawling in 3-phase induction Motor:

Induction motors, particularly the squirrel-cage type, sometimes show a tendency to run at speeds as low as one-seventh ($1/7^{\text{th}}$) of their synchronous speed N_s . This peculiar behaviour of the cage motor at starting is known as crawling of an induction motor. This happens due to harmonic induction torques.

Crawling signifies running of motor at almost one seventh of the rated speed due to interference of seventh harmonics, crawling usually occurs when the motor is started with a coupled mechanical load. This action is due to the fact that flux wave produced by a stator winding is not purely sine wave instead it is a complex wave consisting a fundamental wave and odd harmonics like 3rd, 5th, 7th etc.

COMPARISON BETWEEN INDUCTION MOTOR AND TRANSFORMER:

An induction motor may be considered to be a transformer with a rotating short-circuited secondary. The stator winding corresponds to transformer primary and rotor winding to transformer secondary. The differences between the two are:

- (i) Unlike a transformer, the magnetic circuit of a 3-phase induction motor has an air gap. Therefore, the magnetizing current in a 3-phase induction motor is much larger than that of the transformer. For example, in an induction motor, it may be as high as 30-50% of rated current whereas it is only 1 - 5% of rated current in a transformer.
- (ii) In an induction motor, there is an air gap and the stator and rotor windings are distributed along the periphery of the air gap rather than concentrated on a core as in a transformer. Therefore, the leakage reactances of stator and rotor windings are quite large compared to that of a transformer.
- (iii) In an induction motor, the inputs to the stator and rotor are electrical but the output from the rotor is mechanical. However, in a transformer, input as well as output is electrical.
- (iv) The main difference between the induction motor and transformer lies in the fact that the rotor voltage and its frequency are both proportional to slip s . If f is the stator frequency, E_2 is the per phase rotor e.m.f. at standstill and X_2 is the standstill rotor reactance/phase, then at any slip s , these values are:
 Rotor e.m.f./phase, $E_2' = s E_2$,
 Rotor reactance/phase, $X_2' = s X_2$
 Rotor frequency, $f' = s f$

Comparison between Squirrel Cage and Slipring Induction Motors:

Sl. No.	Characteristics	Squirrel-cage motor	Slip-ring motor
1.	Speed	Almost constant but decreases slight with increased load	Speed decrease more rapidly than in cage motor
2.	Torque	Starting torque is less but running torque is good.	Starting torque is about three times the full load torque.
3.	Current	Starting current is about 5-6 times the full load current	Starting current is about two times the full load current.
4.	Speed control	Done by changing poles.	Done by changing resistance of rotor circuit.

5.	Power factor	Low (about 0.7 to 0.8)	High (about 0.8 to 0.9)
6.	Cost of fabrication	Low	Higher
7.	Maintenance cost	Very low	High (due to presence of brushes, brush gears, extra resistance etc.)
8.	Brushes	Absence of brushes reduces the risk of sparking	More chances of sparking
9.	Efficiency	Higher efficiency	Less efficiency
10.	Applications	Lathe, drills, printing machines, blowers etc.	Lifts, cranes, etc. where high starting torque is needed.

CHAPTER-4 SINGLE PHASE INDUCTION MOTOR

Single phase Induction motor is a popular type of a.c. electrical motor which is used widely in many areas. Single phase Induction motors perform a great variety of useful services in domestic, commercial as well as industrial purposes such as fans, refrigerators, washing machines, vacuum cleaner, kitchen equipment and farming appliance etc.

Single phase motors are generally manufactured in fractional HP ratings below 1 HP for economic reasons. Hence, those motors are generally referred to as fractional horsepower motors with a rating of less than 1 HP.

The characteristics of single phase induction motors are identical to 3-phase induction motors except that single phase induction motor has no inherent starting torque and some special arrangements have to be made for making itself starting.

Construction:

- The construction of a single phase induction motor is similar to that of a 3-phase induction motor. The rotor is cylindrical in shape and always in squirrel cage while the stator carries a single phase winding.□
- The stator winding is placed in slots around the inner periphery of a laminated ring. In addition the stator also carries an auxiliary winding for providing the starting torque, so that the motor becomes self starting.□
- The slots of the rotor are not made parallel to each other but skewed to prevent magnetic locking of stator and rotor teeth.□
- The squirrel cage rotor consists of aluminium bars. These aluminium bars are called rotor conductors and are placed in the slots on the periphery of the rotor.□
- The rotor conductors are permanently shorted by the aluminium rings. It is not possible to add external resistance as the bars are permanently shorted. The absence of slip rings and brushes makes the construction of a single phase induction motor very simple and robust.□

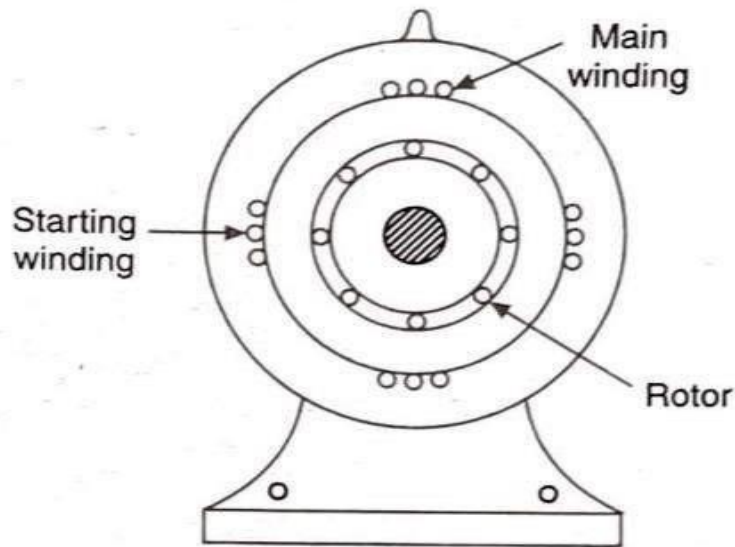

Construction of single phase induction motor

Working:

- When single phase a.c. supply is given to stator winding of single phase induction motor, the alternating current produces an alternating flux called main flux. □
- This magnetic field is pulsating in nature which means that field builds up in one direction falls to zero and again builds up in another direction. □
- This pulsating current is incapable of producing a rotating torque in stationary rotor. But if the rotor is rotate by some external mechanical force in either direction rotor start to rotate in that direction continuously. □
- So single phase induction motor is not self starting. In order to obtain a rotating field, that stator is provided with two windings the main winding and a starting winding. Starting winding is also called auxiliary winding. □
- The phase difference of 90° between two windings is obtained by splitting the phase. □
- So there are two fluxes one is main flux and another is called rotor flux. These two fluxes produce the desired torque which is required by the motor to rotate. □
- When motor pick up 75% of rated speed, starting Winding is generally disconnected from supply and motor continuously run. □

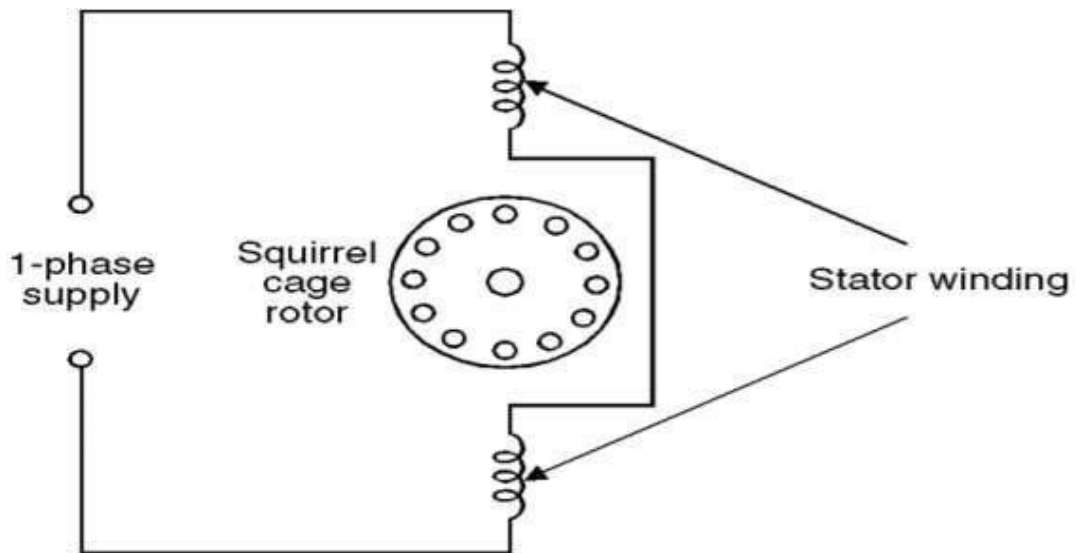

Double revolving field Theory:

Statement: The double field revolving theory states that any alternating quantity can be resolved into two components having magnitude half of the maximum magnitude of the alternating quantity and both these components rotating in opposite direction.

Theory:

In double field revolving theory an alternating sinusoidal flux ($\phi = \phi_m \cos \omega t$) can be represented by two revolving fluxes, each equal to one-half of the maximum value of alternating flux (i.e., $\frac{\phi_m}{2}$) and each rotating at synchronous speed ($N_s = \frac{120f}{P}$, $\omega = 2\pi f$) in opposite directions.

Consider two rotating magnetic fluxes ϕ_1 and ϕ_2 each of magnitude $\frac{\phi_m}{2}$ and rotating in opposite directions with angular velocity ω . The two fluxes start rotating from OX axis at $t = 0$. After time t seconds, the angle through which the flux vectors have rotated is ωt . By resolving the flux vectors along X-axis and Y-axis,

$$\text{Total X-component} = \frac{\phi_m}{2} \cos \omega t + \frac{\phi_m}{2} \cos \omega t = \phi_m \cos \omega t$$

$$\text{Total Y-component} = \frac{\phi_m}{2} \sin \omega t - \frac{\phi_m}{2} \sin \omega t = 0$$

$$\text{Resultant flux, } \phi = \sqrt{(\phi_m \cos \omega t)^2 + 0^2} = \phi_m \cos \omega t$$

Thus the resultant flux vector is $\phi = \phi_m \cos \omega t$ along X-axis. Therefore, an alternating field can be replaced by two revolving fields of half its amplitude rotating in opposite directions at synchronous speed.

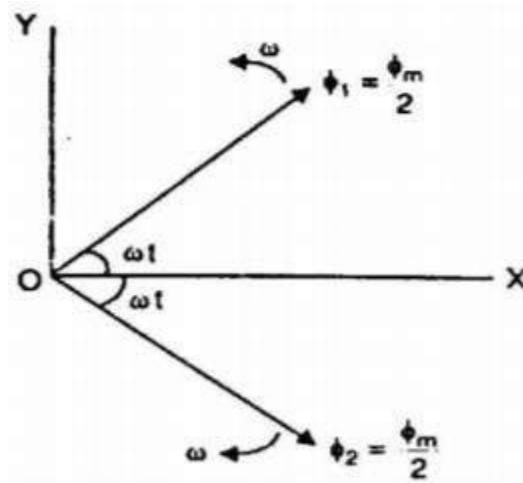

When the rotating flux vectors are in phase, the resultant vector is $\phi = \phi_m$, when out of phase by 180° , the resultant vector $\phi = 0$.

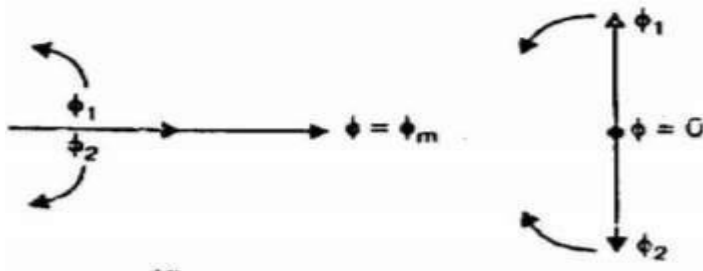

Rotor at standstill

Consider the rotor is stationary and the stator winding is connected to a single-phase supply. The alternating flux produced by the stator winding can be presented as the sum of two rotating fluxes ϕ_1 and ϕ_2 , each equal to one half of the maximum value of alternating flux and each rotating at synchronous speed $N_s = \frac{120f}{P}$ in opposite directions. Let the flux ϕ_1 rotate in anti clockwise direction and flux ϕ_2 , in clockwise direction. The flux ϕ_1 will result in the production of torque T_1 in the anti clockwise direction and flux ϕ_2 will result in the production of torque T_2 in the clockwise direction. At standstill, these two torques are equal and opposite and the net torque developed is zero. Therefore, single-phase induction motor is not self- starting.

Rotor running:

The flux rotating in the clockwise direction is the forward rotating flux (ϕ_f) and that in the other direction is the backward rotating flux (ϕ_b).

The slip w.r.t. the forward flux will be

$$s_f = \frac{N_s - N}{N_s} = s$$

Where N_s = synchronous speed

N = speed of rotor in the direction of forward flux

The slip w.r.t. the backward flux will be

$$S_b = \frac{N_s - (-N)}{N_s} = 2 - s$$

$$s_b = 2 - s$$

Thus for forward rotating flux, slip is s (less than unity) and for backward rotating flux, the slip is $2 - s$ (greater than unity).

Cross-Field Theory:

As soon as the rotor begins to turn at a speed, an emf E is induced in the rotor conductors, as they cut the stator flux. Thus voltage increases as the rotor speed increases. It causes current I_R to flow in the rotor bars facing the stator poles.

This current produces an ac flux ϕ_R which acts at right angle to the stator flux ϕ_s . ϕ_R lags almost 90° behind ϕ_s owing to the inductance of the rotor. The combined action of ϕ_s and ϕ_R produces a revolving magnetic field, similar to that in a three-phase motor. The value of ϕ_R increases with increasing speed, becoming almost equal to ϕ_s at synchronous speed and a nearly perfect revolving field is produced.

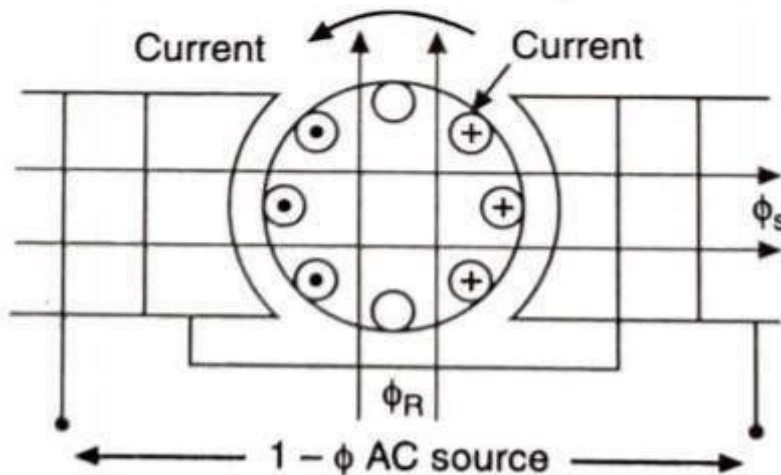

Current induced in the rotor bars due to rotation

Rotor at standstill

The stator winding is excited by the single phase a.c. supply. The supply produces an alternating flux ϕ_s which acts along the axis of stator winding. Due to this flux, emf gets induced in the rotor conductors due to transformer action. This emf circulates current through the rotor conductors. The direction of rotor current is so as to oppose the cause producing it, which is stator flux ϕ_s . Now the rotor conductors experience force whose direction is found by Fleming's left hand rule shown in figure below. Thus overall, the force experienced by the rotor is zero. Hence no torque exists on the rotor and rotor cannot start rotating.

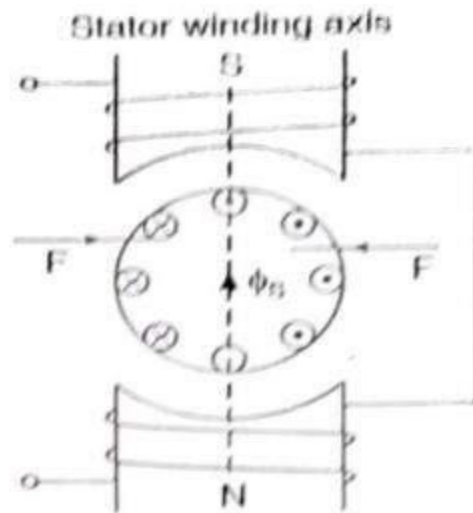

Rotor running:

Assume now that an initial push is given to the rotor in anticlockwise direction. Due to the rotation, the rotor physically cuts the stator flux and emf gets induced in the rotor. This is called rotational emf or speed emf and this emf is in phase with the stator flux Φ_s denoted as E_2 . This emf circulates current through rotor which is I_2 . This current produces its own flux called rotor flux Φ_r . The axis of Φ_r , is at 90° . The axis of stator flux hence the rotor flux is called cross field.

Thus Φ_r , is in quadrature with Φ_s , in space and lags, Φ_s by 90° in time phase. Such two fluxes produce the rotating magnetic field. The direction of this rotating magnetic field will be same as the direction of initial push given. Thus rotor experience a torque in the same direction as that of rotating magnetic field i.e., the direction of initial push.

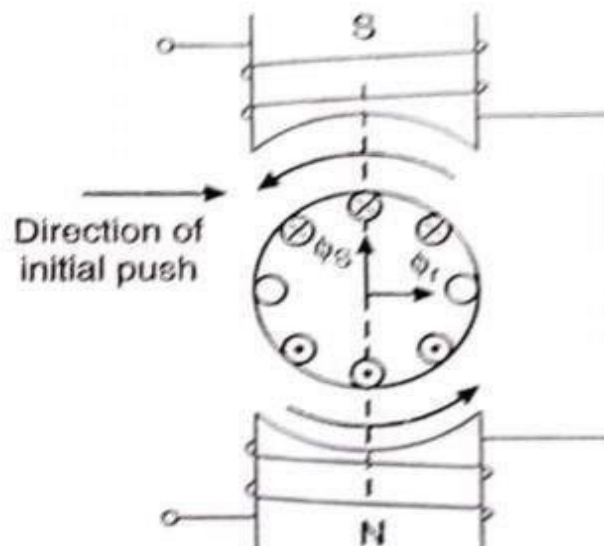

Why Single-phase Induction Motor is not self starting?

According to double field revolving theory, any alternating quantity can be resolved into two components, each component have magnitude equal to the half of the maximum magnitude

of the alternating quantity and both these components rotate in opposite direction to each other.

When a single phase ac supply is given to the stator winding of single phase induction motor, it produces its flux of magnitude ϕ_m . According to the double field revolving theory, this alternating flux, ϕ_m , is divided into two components of magnitude $\frac{\phi_m}{2}$. Each of these components will rotate in opposite direction, with the synchronous speed, N_s .

Let these two components of flux are forward component of flux, ϕ_f and backward component of flux ϕ_b . The resultant of these two components of flux at any instant of time, gives the value of instantaneous stator flux at that particular instant.

$$\phi_r = \frac{\phi_m}{2} + \frac{\phi_m}{2} \text{ or } \phi_r = \phi_f + \phi_b$$

i.e.

At starting, both the forward and backward components of flux are exactly opposite to each other. Also both of these components of flux are equal in magnitude. So, they cancel each other and hence the net torque experienced by the rotor at starting is zero. So, the single phase induction motors are not self starting motors.

Torque-speed characteristics:

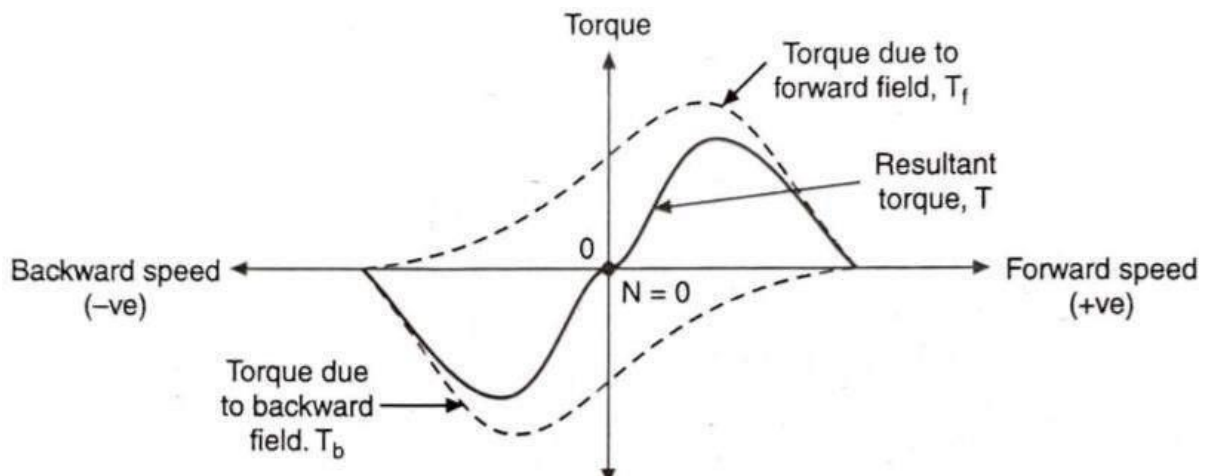

Torque-speed characteristic

At start $N=0$ and at that point resultant torque is zero. So single phase induction motors are not self starting. However if the rotor is given an initial rotation in any direction, the resultant average torque increase in the direction in which the rotor initially rotated and motor starts rotating in that direction.

Making Single-Phase Induction Motor Self-Starting:

The single-phase induction motor is not self starting. However if the rotor is rotate by some external mechanical force in either direction rotor start to rotate in that direction continuously, but in practice it is not possible to give initial torque to rotor externally. Hence some modifications are done in the construction of single phase induction motor to make them self starting.

To make a single-phase induction motor self-starting, a revolving stator magnetic field is produced. This may be achieved by providing an auxiliary winding (starting winding) in addition to the main winding for producing the starting torque, so that motor becomes self starting. When the motor attains sufficient speed, the starting means (i.e., additional winding) may be removed depending upon the type of the motor.

Types of Single Phase Induction Motors:

Single-phase induction motors are classified and named according to the method employed to make them self-starting.

1. **Split-phase motors**-started by two phase motor action through the use of an auxiliary or starting winding.
2. **Capacitor motors**-started by two-phase motor action through the use of an auxiliary winding and a capacitor.
3. **Shaded-pole motors**-started by the motion of the magnetic field produced by means of a shading coil around a portion of the pole structure.

Split-Phase Induction Motor:

- The stator of a split-phase induction motor is provided with an auxiliary or starting winding S in addition to the main or running winding M.
- The starting winding is located 90° electrical from the main winding and operates only during the period when the motor starts up.
- The two windings are so designed that the starting winding S has a high resistance and relatively small reactance while the main winding M has relatively low resistance and large reactance. Consequently, the currents flowing in the two windings have reasonable phase difference α (25° to 30°).

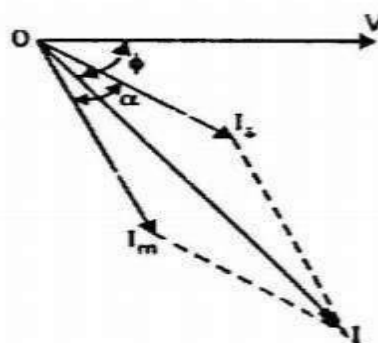
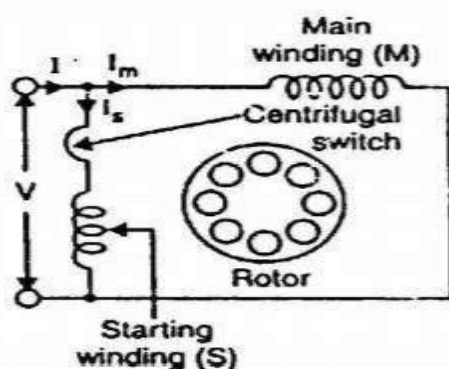

Main Parts of Split Phase Induction Motor:

1. Stator
2. Stator winding
3. Rotor
4. Centrifugal switch
5. End shield

1. **Stator:** Stator consists of steel sheet stampings having slots in its inner periphery. It serves the purpose to carry to stator winding and to cover, support and covering to other parts of the machine.
2. **Stator winding:** Split phase induction motor has two stator windings at a phase displacement of 90° . The running winding is always lower than the starting winding. The starting winding has more resistance. The split phase motors are usually wound to give $\frac{1}{2}$ to $\frac{1}{3}$ horse power.
3. **Rotor:** The rotor of a split phase motor is very similar to the squirrel cage rotor of 3-phase induction motor. The core consists of steel sheet laminations having slots on the rotor periphery. The slots carry a number of copper, aluminium bars. The ends of the conductors in slot are connected and permanently short circuited by means of copper end rings.
4. **Centrifugal switch:** Centrifugal is a mechanical device which is used in split phase induction motor to disconnect the winding when starting the motor attains 75-80% of the synchronous speed. When the rotor of the motor pick up speed about 75% of synchronous speed, switch opens circuit of the starting winding. The centrifugal switch also prevents the motor from putting the drawing excessive current from main by starting winding out of the circuit.
5. **End Shield:** End shields are the end covers of the motor. It protects the motor from the dust and moisture etc. The entire weight of the rotor comes on the end bearings of the motor.

Operation:

- (i) When the two stator windings are energized from a single-phase supply, the main winding carries current I_m while the starting winding carries current I_s .
- (ii) Since main winding is made highly inductive while the starting winding highly resistive, the currents I_m and I_s have a reasonable phase angle α (25° to 30°) between them. Consequently, a weak revolving field approximating to that of a 2-phase machine is produced which starts the motor. The starting torque is given by;

$$T_s = k I_m I_s \sin \alpha$$

where k is a constant whose magnitude depends upon the design of the motor.

- (iii) When the motor reaches about 75% of synchronous speed, the centrifugal switch opens the circuit of the starting winding. The motor then operates as a single-phase induction motor and continues to accelerate till it reaches the normal speed. The normal speed of the motor is below the synchronous speed and depends upon the load on the motor.

Performance Characteristics:

- (i) The starting torque is 1.5 to 2 times the full-load torque (ie starting current is 6 to 8 times the full-load current).
- (ii) Due to their low cost, split-phase induction motors are most popular single phase motors in the market.
- (iii) Since the starting winding is made of fine wire, the current density is high and the winding heats up quickly. If the starting period exceeds 5 seconds, the winding may burn out unless the motor is protected by built-in-thermal relay. This motor is, therefore, suitable where starting periods are not frequent.
- (iv) These motors are essentially constant-speed motors. The speed variation is 2-5% from no-load to full load.
- (v) These motors are suitable where a moderate starting torque is required and where starting periods are infrequent to drive.

Torque-speed characteristics of Split Phase Motor:

The high starting torque is obtained in a split phase induction motor due to high resistance in the starting winding. Such motors are available in sizes 30 to 200 watts. They give fairly constant speed.

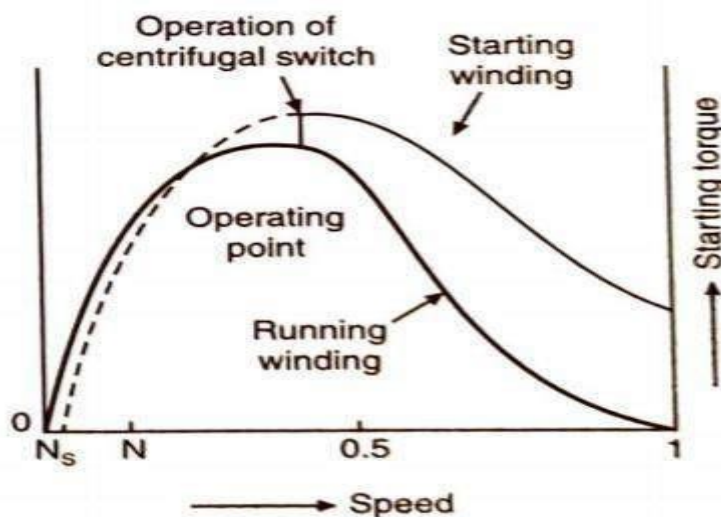

Reversal of direction of rotation: The direction of rotation of a 1-phase (split phase) induction motor can be reversed by reversing (inter-changing) the connections of either starting winding or running winding.

Applications:

- ❖ As starting torque is not so high so this machine is not used where large starting torque is required. It is used for smaller sizes about 0.25 H.P.
- ❖ It is used in washing machines, blowers, wood working tools, grinders and various other low starting torque applications.

Capacitors Motors:

The stator of the capacitor motors have two windings like split-phase induction motor i.e., starting winding and running winding, But in this motor phase angle between the currents of main and starting winding is obtained by using capacitors. Moreover, the phase splitting is achieved by using a capacitor is placed in series with the starting winding. The capacitor induces necessary phase shift.

Advantages of use of capacitor:

1. The starting torque is higher as compared to split phase motor.
2. Power factor of the motors gets improved.
3. Starting current is low.

The capacitor may be connected in series with the starting winding in three different way therefore capacitor motor may be:

- (i) Capacitor start motor
- (ii) Capacitor run motor
- (iii) Capacitor start and capacitor run motor

Capacitor start motor:

- In these types of motors, the necessary splitting of phase for starting is provided using capacitor.
- The capacitor generally used of electrolyte type and designed for short duty period. Electrolyte capacitor is connected in series with the starting winding along with centrifugal switch S.
- This switch disconnects the capacitor as soon as motor reaches 75% of full speed. The motor is not operated on running winding only. It is used where high starting is required.

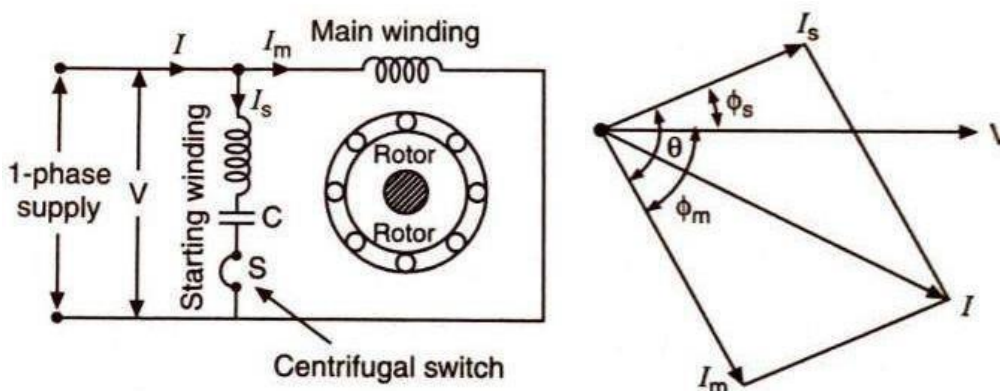

Performance Characteristics:

- (i) The starting characteristics of a capacitor-start motor are better than those of a split-phase motor, both machines possess the same running characteristics because the main windings are identical.
- (ii) The phase angle between the two currents is about 80° compared to about 25° in a split-phase motor. Consequently, for the same starting torque, the current in the starting winding is only about half that in a split-phase motor. Therefore, the starting winding of a capacitor start motor heats up less quickly
- (iii) It is well suited to applications involving either frequent or prolonged starting periods.
- (iv) Its full load efficiency is about 65%.
- (v) It is a constant speed motor as there is a very small fall in speed with load.

Torque-speed Characteristics of Capacitor Start Motor:

Capacitor Start Motor is having a high starting torque as compared to an ordinary split phase motor. The power factor is also improved.

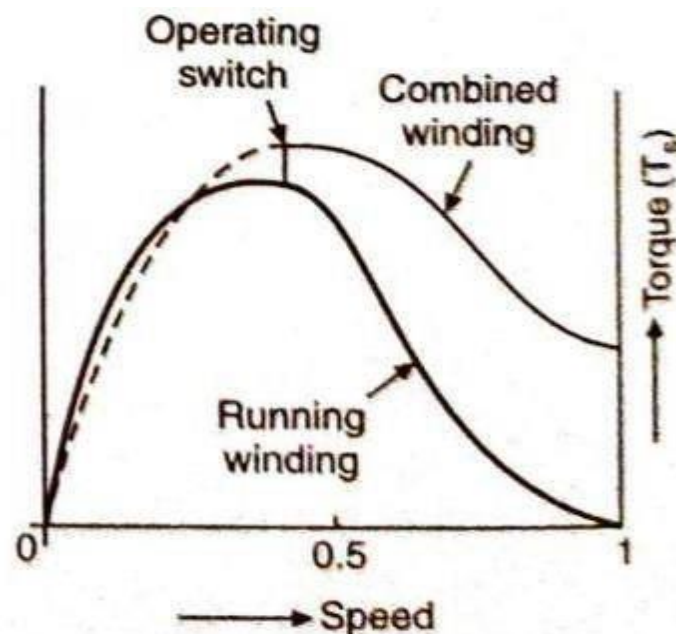

The **direction of rotation** of such motors can be **reversed** simple by interchanging the leads of either running or starting winding.

Applications:

- ❖ Capacitor-start motors are used where high starting torque is required and where the starting period may be long to drive.
- ❖ Hence these motors find their applications in pumps, compressor, conveyer and refrigerators etc. Such motors are available between 0.5 H.P to 1 H.P.

Capacitor run motor:

- In these motors, a paper capacitor is permanently connected in the starting winding. In this case electrolytic capacitor cannot be used since this type of capacitor is designed only for short time rating and hence cannot be permanently connected in the winding.
- Both main as well as starting winding is of equal rating and similar.
- No centrifugal switch or other such device has been used for disconnecting the starting winding. The rotor is squirrel cage.
- In this motor the phase difference between two current is 90° .so starting torque is high.

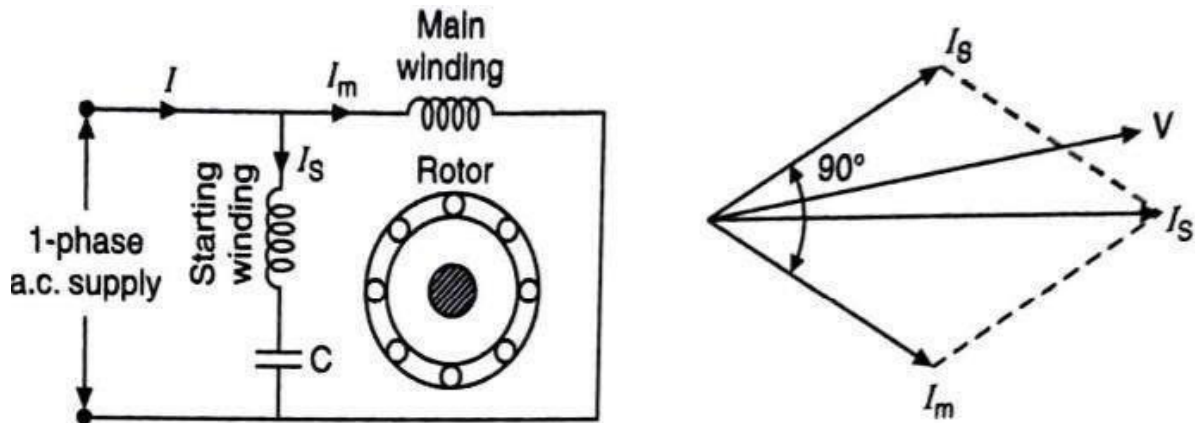

Performance Characteristics:

- The capacitor remains in circuit so resultant line current is low.
- Power factor is improved may be about unity.
- Its full load efficiency is higher about 75%.

Torque-speed Characteristics:

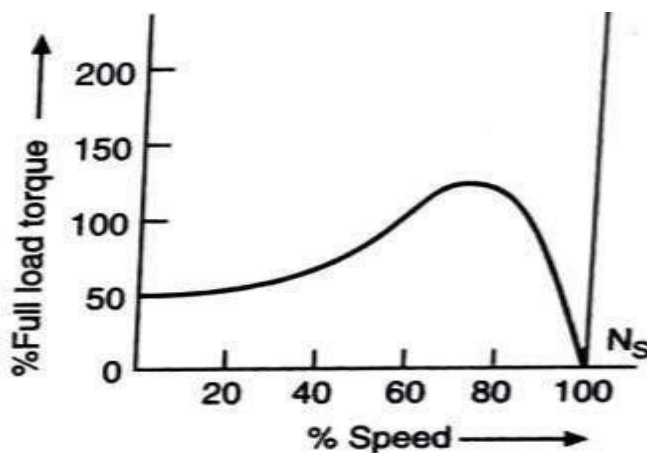

Applications: This motor finds application in fans, room coolers, portable tools and other domestic and commercial appliances.

Capacitor start and capacitor run motor:

- In this case, two capacitors are used one for starting purpose and other for running purpose.
- The capacitors used for starting purpose C_s is of electrolytic type and is disconnected from the supply when the motors attain 75% of synchronous speed with the help of centrifugal switch S.
- Whereas, the other capacitor C_R which remains in the circuit of starting winding during operation is a paper capacitor. Starting capacitor C_s which is of higher value than the value of running capacitor C_R .

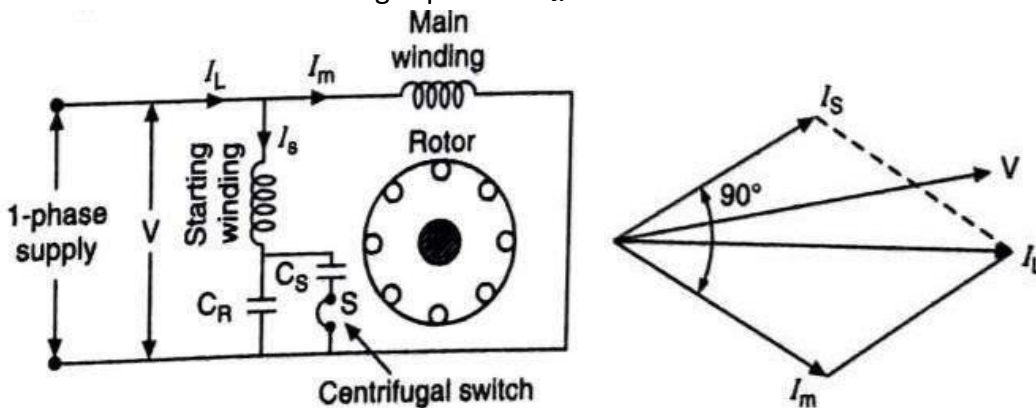

Performance Characteristics:

- The starting winding and the capacitor can be designed for perfect 2-phase operation at any load. The motor then produces a constant torque and not a pulsating torque as in other single-phase motors.
- It improves the overload capacity of the motor.
- It increases the efficiency of the motor.
- It improves the power factor.
- It reduces the noise of the motor.
- This type of motor gives best running and starting operation.

Torque-speed Characteristics:

Such motors operate as two phase motors giving best performance and noiseless operation. Starting torque is high, starting current is low and gives better efficiency and higher power factor.

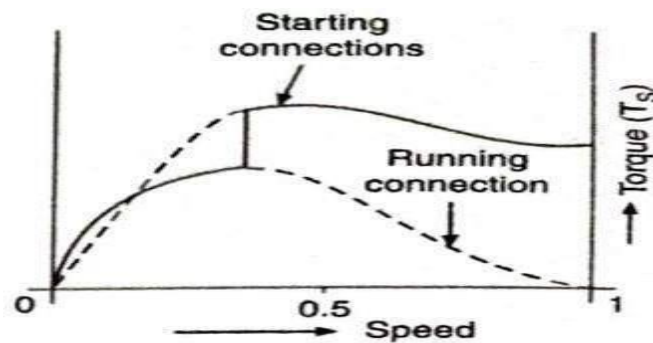

Applications:

Because of constant torque, the motor is vibration free and can be used in: (a) hospitals (b) studios and (c) other places where silence is important.

Shaded-pole Motors:

A shaded-pole motor may be defined as a single phase induction motor provided with short circuited auxiliary winding displaced in magnetic position from the main winding. The shaded pole motor has small output not exceeding 30 watts. Starting torque of shaded pole is very small. It is suitable in low power domestic appliances.

Construction:

- The stator of shaded pole motors have salient pole and rotor is squirrel cage. Each stator pole carries a magnetising coil.
- One third portion of each pole of stator is short circuited using copper band or ring known as Shading band/coil (shaded portion of the pole), because it causes the flux in that portion of the pole surrounded by it to lag behind the flux in the rest of the pole.
- Basically, the pole is split in two parts at its face, shaded part and unshaded part.
- The rotor is also made of laminations. Along the circular surface, there are number of holes in which copper bars are fitted. The ends of these bars are soldered to copper end plate at each end.

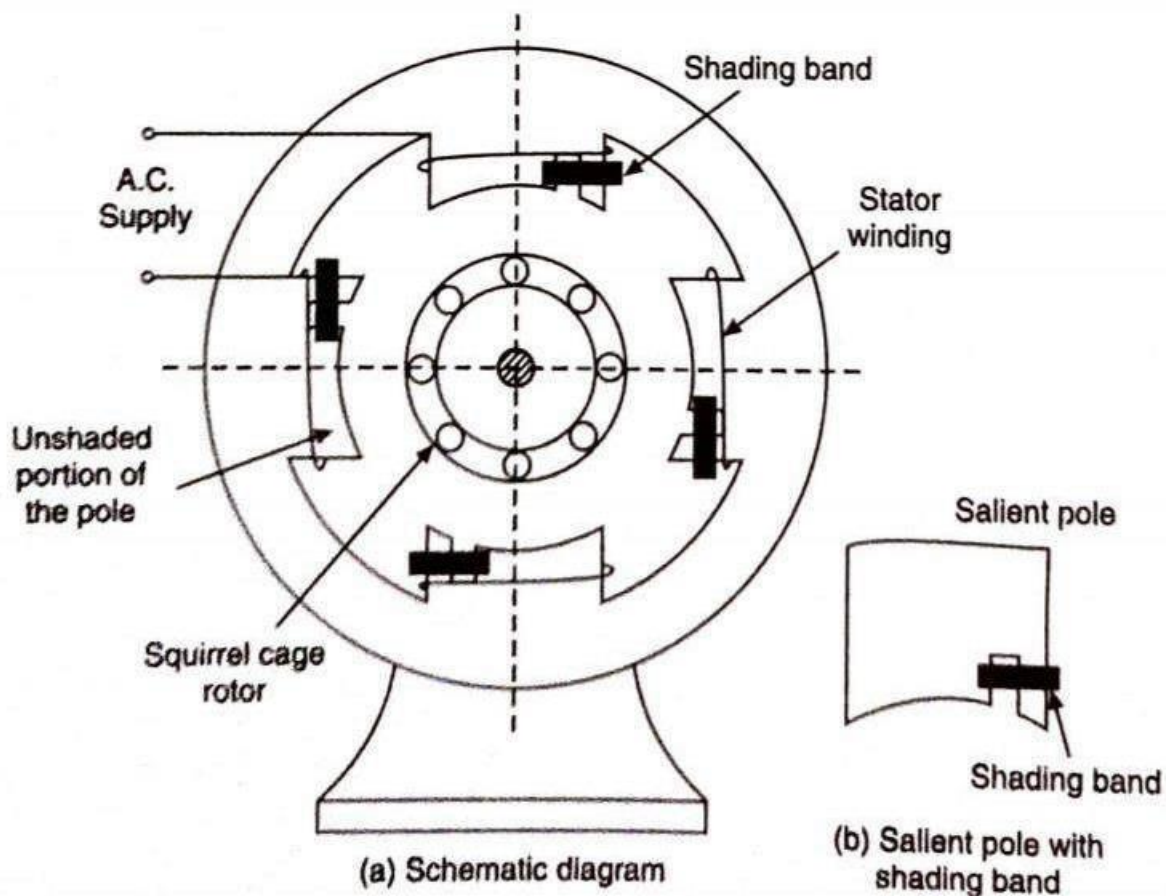

Operation:

- i. When single phase ac. supply is given to the stator of shaded pole induction motor an alternating flux is produced.
- ii. This changing flux induces emf in the shaded coil. Since this shaded portion is short circuited, the current is produced in shaded portion in such a direction to oppose the main flux.
- iii. The flux in shaded pole lags behind the flux in the unshaded pole. The phase difference between these two fluxes produces resultant rotating flux.
- iv. Thus due to this resultant rotating field emf is induced in the rotor, the rotor starts rotating due to single phase induction motor action additional torque is produced and rotor rotates continuously with the speed less than synchronous speed.
- v. The direction of rotating field(flux) is from unshaded to shaded portion of the pole.

The reversal of direction of rotation in shaded pole motor is not possible.

Torque-speed characteristic:

The starting torque is small typically only 30 to 50 percent of the rated torque.

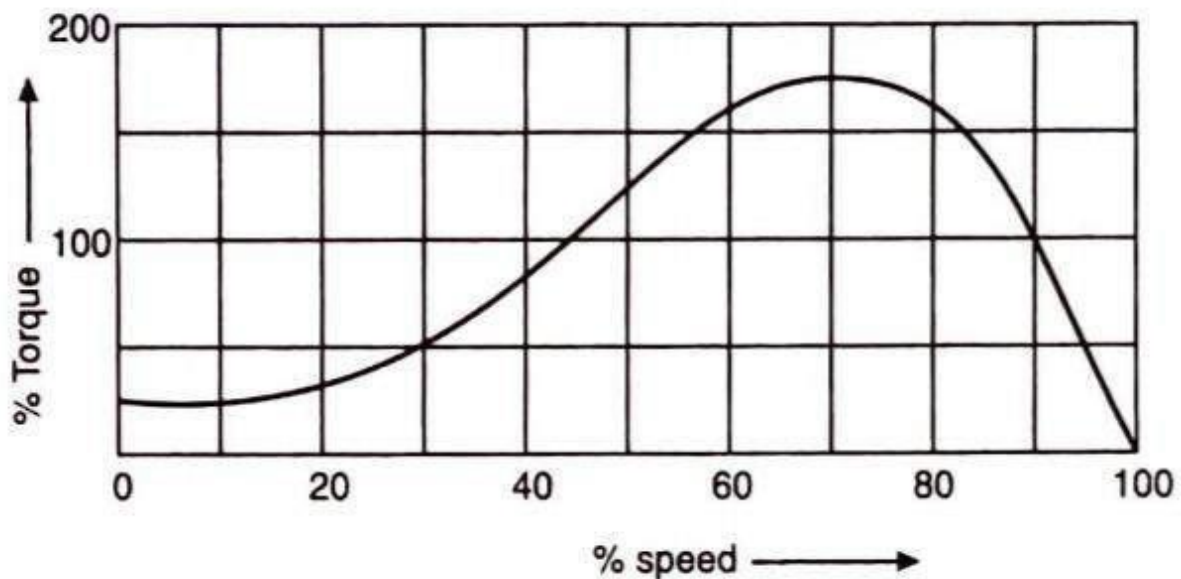

Torque-speed characteristic curve of a shaded pole motor.

Advantages:

1. It has rugged construction.
2. Small in size.
3. Cheaper in cost.
4. Low maintenance is required.
5. It is more reliable
6. There is no commutator, switch, contacts or brushes to give any trouble during operation.

Disadvantages:

1. Starting torque is very low about 8 to 15 percentage.
2. Low Power factor.
3. Small power rating.
4. The shaded-pole motors are inefficient because of the losses in the permanently shorted winding.

Applications:

As starting torque is very low, these motors are mainly used in record players, tape recorders, slide projectors, photo copying machine, starting of electric clocks, hair dryers, toys, gramophones.

CHAPTER-5 COMMUTATOR MOTORS

The commutator motors are so called because the wound rotor of this kind of motor is equipped with a commutator and brushes. This group consists of the following two classes:

1. Those operating on the principle of the series motor in which the energy is conductively carried both to the rotor armature and its series-connected single phase stator field.
2. Those operating on 'repulsion principle' (repulsion motors) in which energy is inductively transferred from the single phase stator field winding to the rotor.

A.C. SERIES MOTOR:

The series motor due to its desirable speed-torque characteristics is almost exclusively use in railway service. It is more convenient and more economical to transmit power and to transform voltages in A.C. systems than with direct currents has lead to the development of the A.C. series motor for use on some of the important electrifications.

Construction:

The construction of an a.c. series motor is very similar to a d.c. series motor but some modifications are necessary in d.c series motor that is to operate satisfactorily on a.c.

Modifications and improvement in design of D.C. series motor to operate on A.C. supply

In order to get satisfactory operation following modifications are to be done

- (i) The yoke and the poles should be made from laminations in order to reduce the eddy currents.
- (ii) In order to reduce the effect of armature reaction, motor is provided with additional compensating winding in series field and armature winding.
- (iii) In order to reduce inductive reactance, motor is built with a few turns. This reduces the voltage drop across the field winding.
- (iv) In order to obtain the required torque, armature turns are increased.
- (v) There is considerable sparking between the brushes and the commutator when the motor is used on a.c. supply. This can be eliminated by using high-resistance leads to connect the coils to the commutator segments.

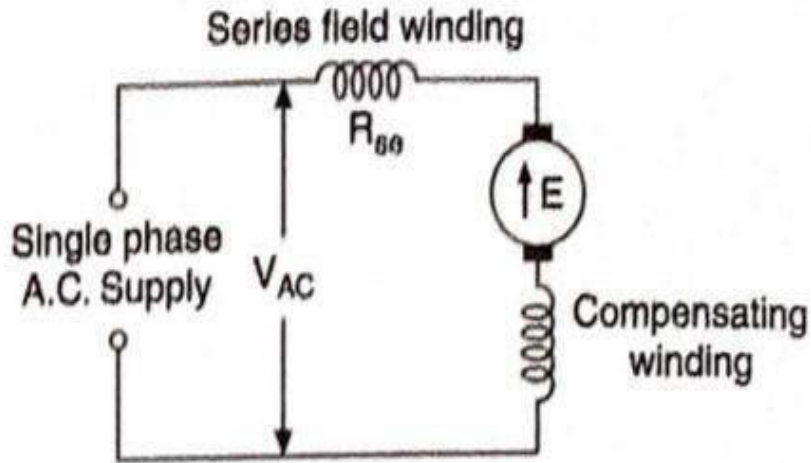

Working Principle:

The working principle of an A.C. series motor is the same as that of a D.C. series motor. The armature and field are wound and interconnected in the same manner as the D.C. series motor.

When the motor is connected to an a.c. supply, the same alternating current flows through the field and armature windings. The field winding produces an alternating flux that reacts with the current flowing in the armature to produce a torque. The field flux and armature current reverse simultaneously every half cycle, but the direction of the torque remains unchanged. The rotor, therefore, continuously rotates in the same direction.

Torque-speed Characteristic:

The torque speed characteristic of an a.c. series motor is similar to that of a d.c. series motor. The torque varies as square of the current and speed varies inversely as the current. The efficiency of a.c. series motor is not good as compared to d.c. series motor due to greater eddy current loss and effect of power factor.

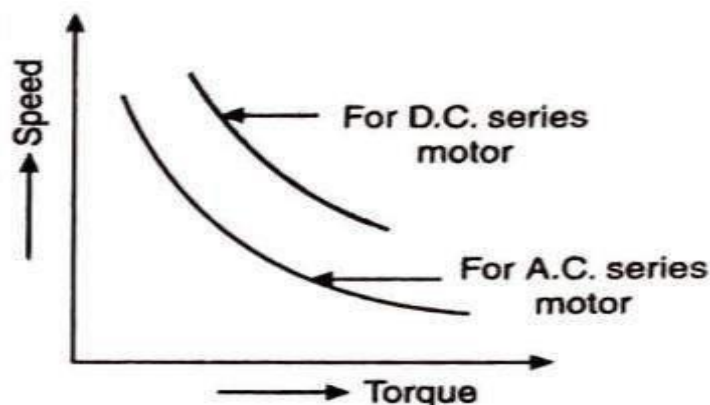

Advantages:

1. It is a constant speed motor.

2. The motor is very useful where constant speed is required such as electric clock etc.

Disadvantages:

To make a.c. series motor from d.c. series motor special structural changes must be needed to make in the motor to make it a practical and reasonable efficient machine.

Applications:

1. The most important application of a.c. series motor in electric traction.
2. For driving electric clocks and phonographs.

UNIVERSAL MOTOR:

- Fractional-horsepower series motors that are adapted for use on either D.C. or A.C. circuits of a given voltage are called universal motors.
- These motors are generally series wound (armature and field winding are in series), and hence produce high starting torque.
- They run at lower speed on AC supply than they run on DC supply of same voltage, due to the reactance voltage drop which is present in AC and not in DC.

There are two basic types of universal motor: (i) compensated type and (ii) uncompensated type

Construction of Universal Motor:

The construction of a universal motor is very similar to construction of a d.c. machine.

- It consists of a stator on which field poles are mounted. Field coils are wound on the field poles.
- However, the whole magnetic path (stator field) circuit and also armature is laminated. Lamination is necessary to minimize the eddy currents which induce while operating on AC.
- The rotary armature is of wound type having straight or skewed slots and commutator with brushes resting on it.
- The commutation on AC is poorer than the for DC, because of the current induced in the armature coils. For that reason brushes used are having high resistance.

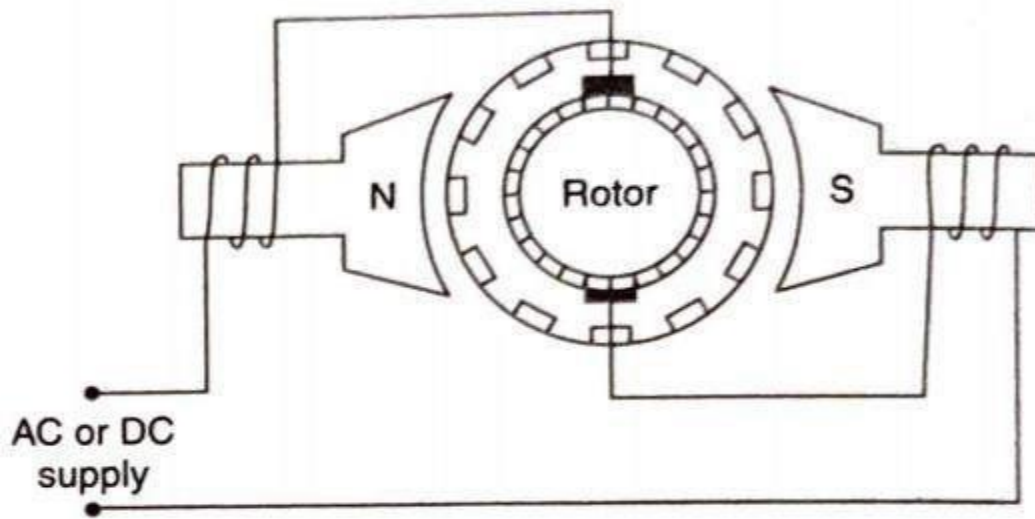

Working of Universal Motor:

A universal motor works on either DC or single phase AC supply. When the universal motor is fed with a DC supply, it works as a DC series motor. When current flows in field winding, it produces an electromagnetic field. The same current also flows from the armature conductors. When a current carrying conductor is placed in an electromagnetic field, it experiences a mechanical force. Due to this mechanical force, or torque, the rotor starts to rotate. The direction of this force is given by Fleming left hand rule.

When fed with AC supply, it still produces unidirectional torque. Because, armature winding and field winding are connected in series, they are in same phase. Hence as polarity of AC changes periodically, the direction of current in armature and field winding reverses at the same time. Thus, direction of magnetic field and the direction of armature current reverses in such a way that the direction of force experienced by armature conductors remains same. Thus, regardless of AC or DC supply, universal motor works on the same principle that DC series motor.

Reversal of Direction of Rotation:

The direction of rotation can be changed by interchanging connections to the field with respect to the armature as in a d.c. series motor.

Speed-Torque Characteristics:

Speed/torque characteristics of a universal motor is similar to that of DC series motor.

- (i) The speed of universal motor is low at full load and very high at no load.
- (ii) The motor torque is high for large armature current giving high starting torque.
- (iii) At Full load, the PF is about 90%
- (iv) Most of the universal motors are designed to operate at higher speeds, exceeding 3500 RPM.
- (v) Universal motor may be built to operate satisfactorily either 50 Hz a.c. or direct current, at 115 or 230 volts d.c.

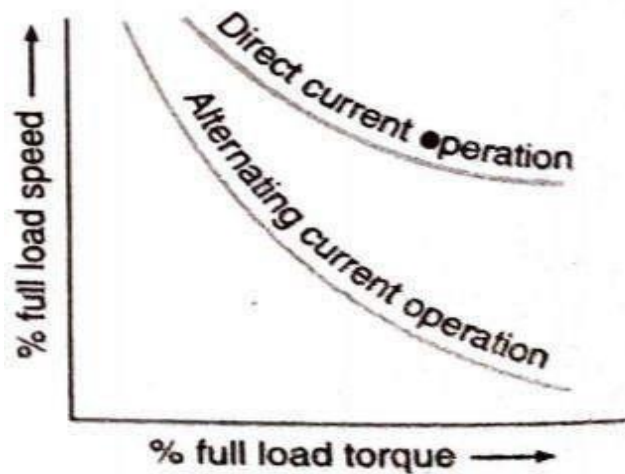

Advantages of Universal Motor:

1. It is small in size.
2. Less expensive.
3. High speed from 3600 rpm to 25000 rpm
4. High torque at low and intermediate speeds.
5. Higher power output.

Disadvantages:

1. Poor commutation on a.c operation.
2. Motor become noisy at high speeds.
3. Requirement for careful balancing to avoid vibrations.

Applications:

Due to the good starting torque, high efficiency and speed, these motors suitable for following applications.

1. Universal motors find their use in various home appliances like vacuum cleaners, drink and food mixtures, domestic sewing machine and hair dryers.
2. The higher rating universal motors used in portable drills, blenders etc.
3. Used in portable toys, hand tools, electric typewriters, cameras and electric shavers etc.

REPULSION MOTOR:

A repulsion motor is similar to an a.c. series motor except that

- (i) Brushes are not connected to supply but are short-circuited. Consequently, currents are induced in the armature conductors by transformer action.
- (ii) The field structure has non-salient pole construction.

By adjusting the position of short-circuited brushes on the commutator, the starting torque can be developed in the motor.

Construction:

- The field of stator winding is wound like the main winding of a split-phase motor and is connected directly to a single-phase source.
- The armature or rotor is similar to a d. c. motor armature with drum type winding connected to a commutator.
- The brushes are not connected to supply but are connected to each other or short-circuited. Short-circuiting the brushes effectively makes the rotor into a type of squirrel cage.
- By using a commutator motor with brushes short-circuited, it is possible to vary the starting torque by changing the brush axis. It has also better power factor than the conventional single-phase motor.

Principle of operation:

Let us consider a two-pole repulsion motor with its two short-circuited brushes shown in figure below.

- In Fig.(i), the brush axis is parallel to the stator field. When the stator winding is energized from single-phase supply, e.m.f. is induced in the armature conductors (rotor) by induction. By Lenz's law, the direction of the e.m.f. is such that the magnetic effect of the resulting armature currents will oppose the increase in flux. With the brush axis in the position, current will flow from brush B to brush A where it enters the armature and flows back to brush B through the two paths ACB and ADB. With brushes set in this position, half of the armature conductors under the N-pole carry current inward and half carry current outward and similar under S-pole. Therefore, as much torque is developed in one direction as in the other and the armature remains stationary. The armature will also remain stationary if the brush axis is perpendicular to the stator field axis. It is because even then net torque is zero.
- If the brush axis is at some angle other than 0° or 90° to the axis of the stator field, a net torque is developed on the rotor and the rotor accelerates to its final speed shown in Fig.(ii). The brushes have been shifted clockwise through some angle from the stator field axis. Now e.m.f. is still induced in the direction and current flows through the two paths of the armature winding from brush B to brush A. Because of the new brush positions, the greater part of the conductors under the N pole carry current in one direction while the greater part of conductors under S-pole carry current in the opposite direction. With brushes in the position torque is developed in the clockwise direction and the rotor quickly attains the final speed.
- The total armature torque in a repulsion motor can be

$$T_a \propto \sin 2\alpha$$

where α = angle between brush axis and stator field axis

For maximum torque, $2\alpha = 90^\circ$ or $\alpha = 45^\circ$

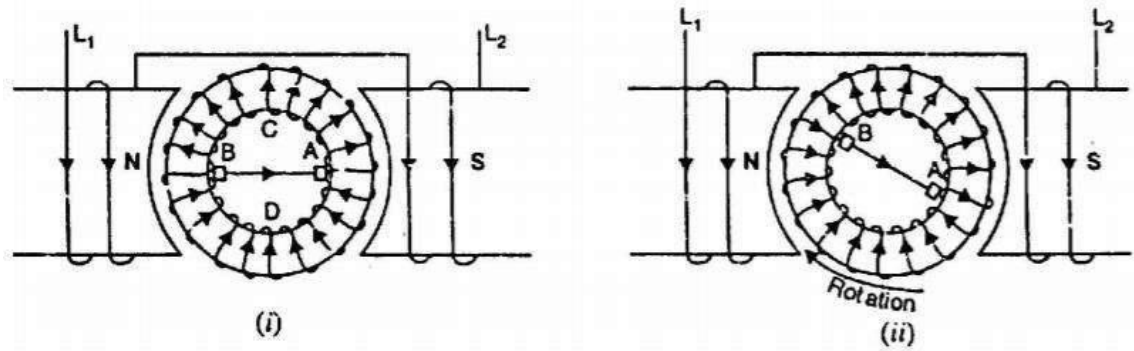

Reversal of Direction of Rotation:

- The direction of rotation of the rotor depends upon the direction in which the brushes are shifted. If the brushes are shifted in clockwise direction from the stator field axis, the net torque acts in the clockwise direction and the rotor accelerates in the clockwise direction. □
- If the brushes are shifted in anti-clockwise direction the armature current under the pole faces is reversed and the net torque is developed in the anti-clockwise direction. □ Thus a repulsion motor may be made to rotate in either direction depending upon the direction in which the brushes are shifted.

Characteristics:

- (i) The repulsion motor has characteristics very similar to those of an a.c. series motor i.e., it has a high starting torque and a high speed at no load.
- (ii) The speed which the repulsion motor develops for any given load will depend upon the position of the brushes.
- (iii) In comparison with other single-phase motors, the repulsion motor has a high starting torque and relatively low starting current.

REPULSION-START INDUCTION-RUN MOTOR:

The action of a repulsion motor is combined with that of a single phase induction motor to produce repulsion-start induction-run motor. The machine is started as a repulsion motor with a corresponding high starting torque but after it reaches 75% of its full speed, a centrifugal device short-circuits the commutator so that the machine then operates as a single-phase induction motor.

The repulsion-start induction-run motor has the same general construction of a repulsion motor. The only difference is that in addition to the basic repulsion motor construction, it is equipped with a centrifugal device fitted on the armature shaft. When the motor reaches 75% of its full speed, the centrifugal device forces a short-circuiting ring to come in contact with the inner surface of the commutator. This short-circuits all the commutator bars. The rotor then resembles squirrel-cage type and the motor runs as a

single-phase induction motor. At the same time, the centrifugal device raises the brushes from the commutator which reduces the wear of the brushes and commutator as well as makes the operation quiet.

Characteristics:

- (i) The starting torque is 2.5 to 4.5 times the full-load torque and the starting current is 3.75 times the full-load value.
- (ii) Due to their high starting torque, repulsion-motors were used to operate devices such as refrigerators, pumps, compressors, grinding devices, floor-polishing etc.

REPULSION-INDUCTION MOTOR:

The repulsion-induction motor produces a high starting torque entirely due to repulsion motor action. When running, it functions through a combination of induction-motor and repulsion motor action. **Construction:**

It consists of a stator and a rotor (or armature).

- (i) The stator carries a single distributed winding fed from single-phase supply.
- (ii) The rotor is provided with two independent windings placed one inside the other. The inner winding is a squirrel-cage winding with rotor bars permanently short-circuited. Placed over the squirrel cage winding is a repulsion commutator armature winding. The repulsion winding is connected to a commutator on which ride short-circuited brushes. There is no centrifugal device and the repulsion winding functions at all times.

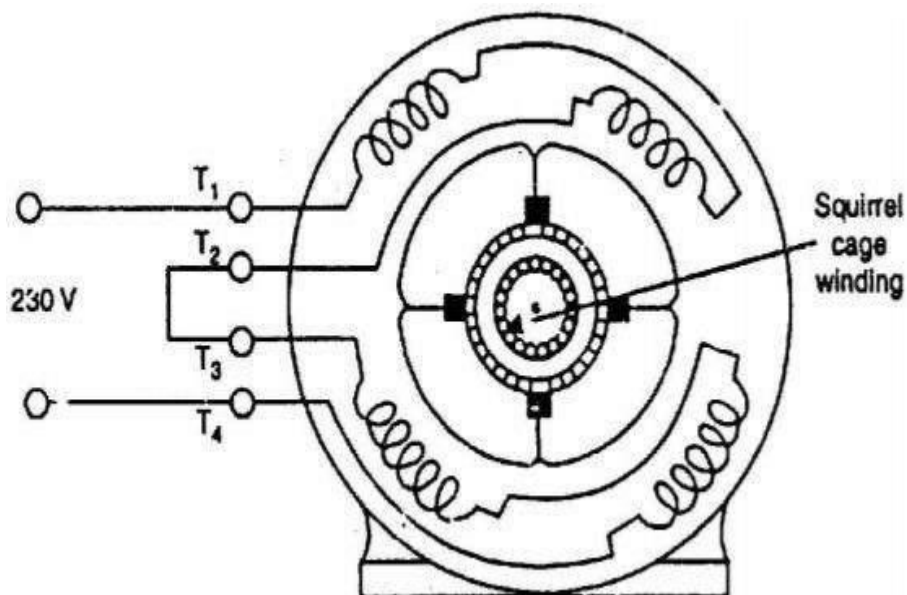

Operation:

- (i) When single-phase supply is given to the stator winding, the repulsion winding (i.e., outer winding) is active. Consequently, the motor starts as a repulsion motor with a corresponding high starting torque.
- (ii) As the motor speed increases, the current shifts from the outer to inner winding due to the decreasing impedance of the inner winding with increasing speed. Consequently, at running speed, the squirrel cage winding carries the greater part of rotor current. This shifting of repulsion motor action to induction-motor action is thus achieved without any switching arrangement.
- (iii) The motor starts as a repulsion motor. When running, it functions through a combination of principle of induction and repulsion; the former being predominant.

Characteristics:

- (i) The no-load speed of a repulsion-induction motor is somewhat above the synchronous speed because of the effect of repulsion winding. However, the speed at full-load is slightly less than the synchronous speed as in an induction motor.
- (ii) The speed regulation of the motor is about 6%.
- (iii) The starting torque is 2.25 to 3 times the full-load torque; the lower value being for large motors. The starting current is 3 to 4 times the full-load current.

Applications:

This type of motor is used for applications requiring a high starting torque with essentially a constant running speed. Its field of application includes house-hold refrigerators, garage air pumps, petrol pumps, compressors, machine tools, mixing machines, lifts and hoists etc. The common sizes are 0.25 to 5 H.P.

CHAPTER-6 SPECIAL ELECTRICAL MACHINE

Stepper Motor:

These motors are also called stepping motors or step motors. The name stepper is used because this motor rotates through a fixed angular step in response to each input current pulse received by its controller. they can be controlled directly by computers, microprocessors and programmable controllers.

The stepper motor rotates in discrete step angles. Its output shaft rotates in a series of discrete angular intervals or steps, one step being taken each time a command pulse is received. When a definite number of pulses are supplied, the shaft turns through a definite known angle. This makes the motor well-suited for open-loop position control because no feedback need be taken from the output shaft.

Stepping motors are ideally suited for situations where either precise positioning or precise speed control or both are required in automation systems. Such motors develop torques ranging from 1μ N-m (in a tiny wrist watch motor of 3 mm diameter) up to 40 N-m in a motor of 15 cm diameter suitable for machine tool applications. Their power output ranges from about 1 W to a maximum of 2500 W.

The only moving part in a stepping motor is its rotor which has no windings, commutator or brushes. This makes the motor quite robust and reliable. Absence of brushes and commutator makes the operation of stepper motor free from noise.

Principle of Operation:

Stepper motors work on the principle of electro-magnetism. A series of electromagnets arranged in a circle are energised in sequence by the train of pulses. The magneto-motive force developed in them and interact with the rotor (iron piece) and cause it to turn in clockwise or anticlockwise direction depending upon the energised electromagnet position.

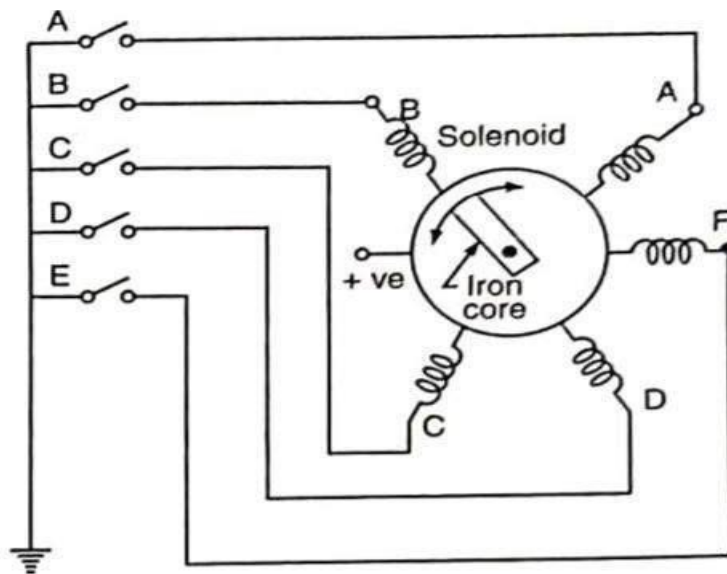

Advantages:

1. Low cost.
2. Small in size.
3. It is available in wide range of step angles i.e. from 1.8° to 90° .
4. Excellent torque at low speeds.
5. Low maintenance (brushless).
6. The starting current is low.
7. Excellent for precise positioning control.
8. It has low speed without reduction gears.

Disadvantages:

1. Overall efficiency is low
2. Limited size available
3. Torque decreases with speed

Applications of Stepper Motor:

Such motors are used for

1. Operation control in computer peripherals.
2. In textile industry
3. IC fabrications and robotics etc
4. For incremental motion such as typewriter, line printers, tape drives, floppy disk drivers.
5. For numerical controlled machine tools, process controls system and X-Y plotters.
6. It is also used in commercial, military and medical purpose. In such cases it performs the function like mixing, cutting, striking etc.
7. They also take part in the manufacture of packed food stuffs etc.
8. As the motor speed is proportional to rate of common pulses, it can be used for speed control.

Characteristics of Stepper Motor:

- As the stepping rate is increased, the motor can provide less torque because the rotor has less time to drive the load from one position to the next position.□
- The start range is that in which load position follows the pulse without losing steps. Slew range is that in which the load velocity follows the pulse rate without losing steps but cannot start or reverse on signal. The maximum torque point is the point at which the torque is maximum.□
- If the stepping rate is increased too quickly, the motor loses synchronism and stops. If when the motor is slewing, command pulses are suddenly stopped instead of being progressively slowed.□
- When the pulse rate is high, the shaft rotation seems continuous. Operation at high□ speeds is called 'slewing'.

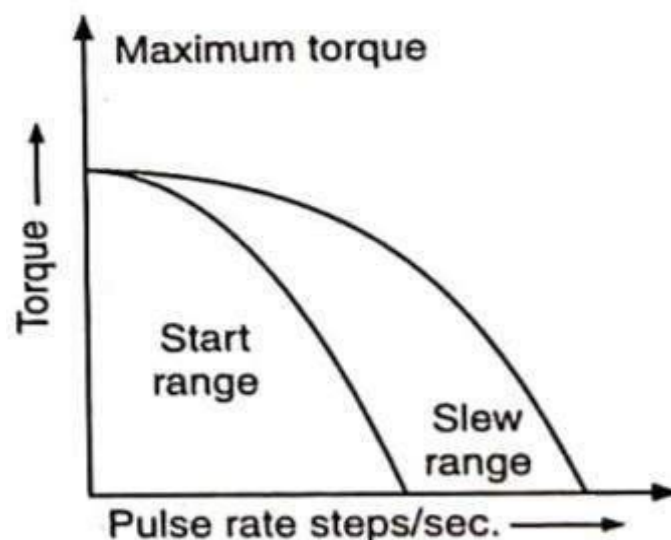

Torque pulse rate characteristics of stepper motor **Definition**

related to Stepper Motor:

1. **Step Angle:**

The angle through which the motor shaft rotates for each command pulse is called the step angle. Smaller the step angle, greater the number of steps per revolution and higher the resolution or accuracy of positioning obtained. The step angles can be as small as 0.72° or as large as 90°. But the most common step sizes are 1.8°, 2.5°, 7.5° and 15°. Step angle can be measured in terms of angular displacement of rotor shaft. It is denoted by β .

The value of step angle can be expressed either in terms of the rotor and stator poles (teeth) N_r and N_s respectively or in terms of the number of stator phases (m) and the number of rotor pole (teeth).

$$\beta = \frac{N_s - N_r}{N_s N_r} \times 360^\circ$$

$$\beta = \frac{360^\circ}{m \times N_r} = \frac{360^\circ}{\text{No. of Stator phases} \times \text{No. of rotor poles}}$$

Or

2. Resolution:

Resolution is defined as the number of steps needed to complete one revolution of the rotor shaft. Higher the resolution, greater the accuracy of positioning of objects by the motor.

$$\text{Resolution} = \text{Number of steps per revolution} = \frac{360^\circ}{\beta}$$

3. Pulse frequency resolution:

If f is the stepping frequency (or pulse rate) in pulses per second (pps) and β is the step angle, then motor shaft speed is given by

$$n = \frac{\beta \times f}{360^\circ} \text{ rps} = \text{pulse frequency resolution}$$

Types of Stepper Motors:

The stepper motor can be classified depending upon the type of rotor. The following are main types of stepper motor.

1. Variable Reluctance (VR) stepper motor
2. Permanent magnet (PM) stepper motor
3. Hybrid stepper motor.

Variable Reluctance (VR) stepper motor:

Construction: A variable reluctance stepper motor has no permanent magnet on the rotor. The rotor is made of ferromagnetic materials having teeth (pole) on the outer periphery to obtain variable reluctance is called variable reluctance motor.

A variable reluctance stepper motor has salient pole on the stator. The stator having slots in which multiple multiphase winding is placed.

The rotor is made of soft iron material and carries no windings.

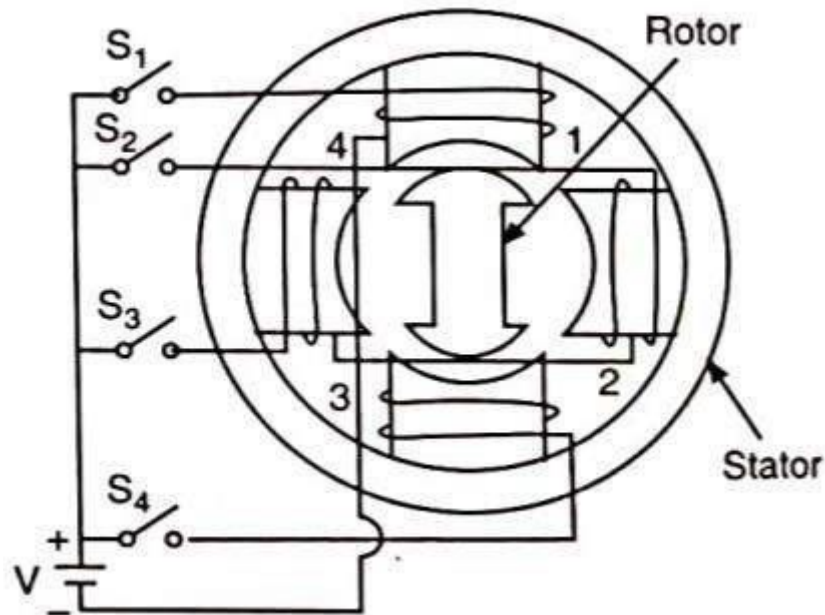

Four phase 4/2 pole variable reluctance motor

Working: When the stator windings are excited in a proper sequence from d.c. supply with the help of switches, a magnetic field is produced. It occupies the position where the reluctance is minimum. Therefore the rotor axis aligns itself to the stator field axis.

When winding no.1 excited, the rotor aligns with the axis of phase 1. The rotor is stable in this position, until phase no.1 is de-energised. Next phase no. 2 excited and no. 1 is disconnected. The rotor moves through one step 90° in the clockwise direction.

Further phase 3 is excited and phase 2 is disconnected. The rotor is again moves through 90° in clockwise direction.

Thus on exciting the phases in sequence 1,2,3,4 & 1. The rotor moves through a step of 90° in clockwise direction at each transition. Therefore the rotor completes one revolution in four steps. The direction of rotation can be reverse by reversing the sequence of switching i.e., 1,4,3,2,1. The direction of rotation is also independent of direction of current through the phases.

Summary: Variable stepper motor

1. The rotor is a soft iron cylinder with salient poles.
2. This the most in expensive stepper motor.
3. Large step angle.
4. A lead screw is often mounted to the shaft for linear stepping motion.

Permanent magnet (PM) stepper motor:

Construction: In Permanent stepper motor the stator is similar to variable reluctance motor but the rotor is made of permanent magnet of ferrite having even number of poles. The stator has projecting poles but rotor is cylindrical and radially magnetized permanent magnets.

The end connections of the winding are taken out to the terminal box for d.c. excitations. The rotor is cylindrical consisting of even number of poles made of high retentivity.

The rotor poles align with the stator poles depending on the excitation of the winding.

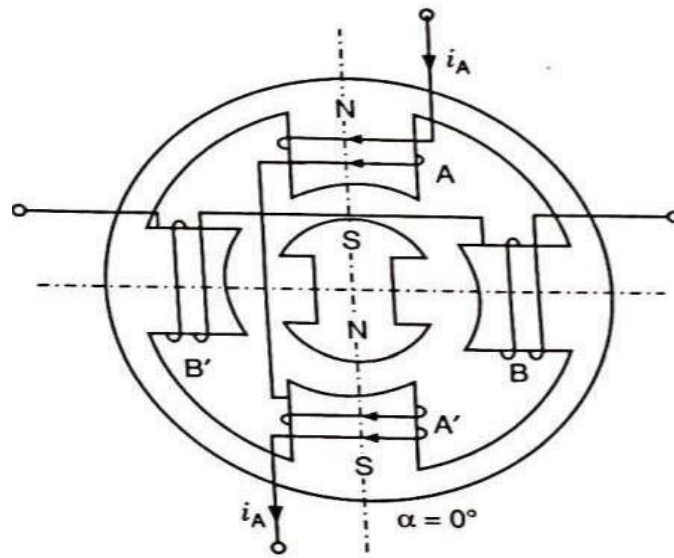

Two phase 4/2 pole permanent magnet stepper motor

Working: The two coils A-A' are connected in series to form phase A winding the two coils B-B' connected in series form phase B winding. When winding B is energized by the exciting current and A does not carry any current the rotor moves by step of 90° in clockwise direction. Now if winding A is energised and B does not carry any current, the rotor moves further by step of 90° in clockwise direction. For further movement of 90° the winding A is energised and so on.

To get rotation in anticlockwise direction the sequence of the stator winding is changed. Winding, A is energised first and then winding B and so on.

Truth table Phase

Cycle	A	B	Position α°
+	1	0	0
	0	1	90°
-	1	0	180°
	0	1	270°
+	1	0	360°

Advantages of Permanent Magnet Stepper Motor:

1. Permanent magnet stepper motor do not require any external exciting current.
2. Power consumption is low.
3. It has high starting torque as compared to variable reluctance stepper motor.

Disadvantages:

1. It has slower acceleration.
2. It is difficult to manufacture small permanent stepper motor with large number of poles.
3. It has high inertia.
4. Step size of such motors is relatively large ranging from 30° to 90°

Summary of Permanent Stepper Motor

1. The rotor is a permanent magnet, often ferrite magnetized with number of poles.
2. Large to moderate step angle
3. Often used in computer printer to advance paper.

HYBRID STEPPER MOTORS:

A hybrid stepper motor combines the features of variable reluctance motor and permanent magnet stepper motors. The direction of its torque also depends upon the polarity of the stator current. The rotor of such type motor consists of a permanent magnet.

Construction: It is the combination of permanent magnet stepper motor and variable reluctance stepper motor. The rotor consists of a permanent magnet which is magnetized axially to make N and S pole.

Two end-caps are fitted at both ends of this axial magnet. These end-caps consist of equal number of teeth which are magnetized with polarities by the axial magnet.

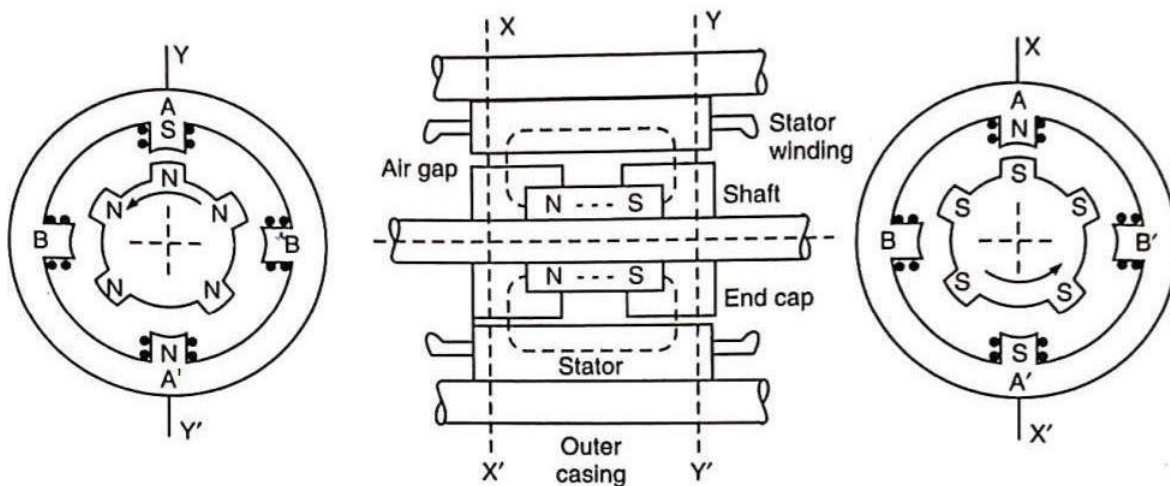

(a) Cross-section YY'

(b) Axial view

(c) Cross-section XX'

Working: Phase A is excited in such a fashion that the top portion of stator pole is a S-pole so that it attracts the N-pole of the rotor and brings it in line with the A - A' axis. Further

to turn to rotor phase A is de-energized and phase B is excited positively. The rotor will turn in clockwise (CW) direction by a full step of $18^\circ \left((5 - 4) \times \frac{360^\circ}{5 \times 4} \right)$.

Next, phase A and B are energized negatively one after the other to produce further rotation of 18° each in the same direction.

The hybrid stepping motors are built with more rotor poles than shown in order to give higher angular resolution.

As compared to variable reluctance motor, hybrid motor requires less excitation to achieve a given torque.

Advantages of Hybrid Stepper Motors:

The main advantages of hybrid stepper motors as compared with variable reluctance stepper motors are:

1. It is used where stepping is small (e.g., 1.5° , 2.5°)
2. Higher efficiency at lower speeds.

Disadvantages of Hybrid Stepper Motors:

1. More weight due to the presence of rotor magnet.
2. More costly than variable reluctance stepper motors.

Summary of Hybrid Stepper Motor:

1. The step angle smaller than variable reluctance or permanent magnet steppers motor.
2. The rotor is permanent magnet with fine teeth.
3. The stator windings are divided into not less than two phases.

Comparison between permanent magnet, variable reluctance and hybrid stepper motor:

Sl. No.	Characteristic	Permanent Magnet	Variable Reluctance	Hybrid
1.	Cost	Cheapest	Moderate	Most expensive
2.	Resolution	$30^\circ - 3^\circ/\text{step}$	$1.8^\circ/\text{per step}$	$1.8^\circ/\text{per step}$ and smaller
3.	Noise	Quiet	Noisy	Quiet
4.	Design	Moderately complex	Simple	Complex
5.	Stepping	Run in full half and microstepping	Run in full step only	Run in full half and microstepping

Due to the manufacturing process for the permanent magnet motor it is cheaper. Hybrid and variable reluctance motors are more expensive due to the geared rotor.

Permanent magnet rotors are physically limited by the number of pole pairs. Hybrid and variable reluctance motor have very fine resolution due to the geared construction of the rotor.

However noise of the motor is also taken into consideration. Variable reluctance motors are typically noisier than their permanent magnet or hybrid motor.

CHAPTER -7 THREE PHASE

TRANSFORMERS

Vector Group of Transformer:

Three phase transformer consists of three sets of primary windings one for each phase and three sets of secondary winding wound on the same core.

The primary windings are connected in one of several ways. The two most common configurations are the star, in which all three non-polarities ends are connected together and delta, in which the polarity end of one winding is connected to the non-polarity end of the next, The secondary windings are connected similarly. This means that a 3-phase transformer can have its primary and secondary windings connected the same (star-star or delta-delta) or differentially (star-delta or delta-star).

- If the secondary voltage waveforms are in phase with the primary waveforms when the primary and secondary windings are connected the same way. This condition is called "no phase shift.
- When the primary and secondary winding are connected differentially the secondary voltage waveforms will differ from the corresponding primary voltage waveforms by 30° electrical degrees. This is called a 30 degree phase shift.
- When two transformers are connected in parallel, then phase shifts must be identical, if not, a short circuit will occur when the transformers are energized.

The three phase transformer windings can be connected several ways. Based on the windings connection the "vector group" of the transformer is determined.

The transformer "vector group" is indicated on the name plate of transformer by the manufacturer. The "vector group" indicates the phase difference between the primary and secondary sides, introduced due to that particular configuration of transformer windings connection.

The determination of "vector group" of transformer is most important before connecting two or more transformers in parallel.

If two transformers of different "Vector Groups" are connected in parallel then phase difference exist between the secondary of the transformer and large circulating current flows between two transformers which is very detrimental.

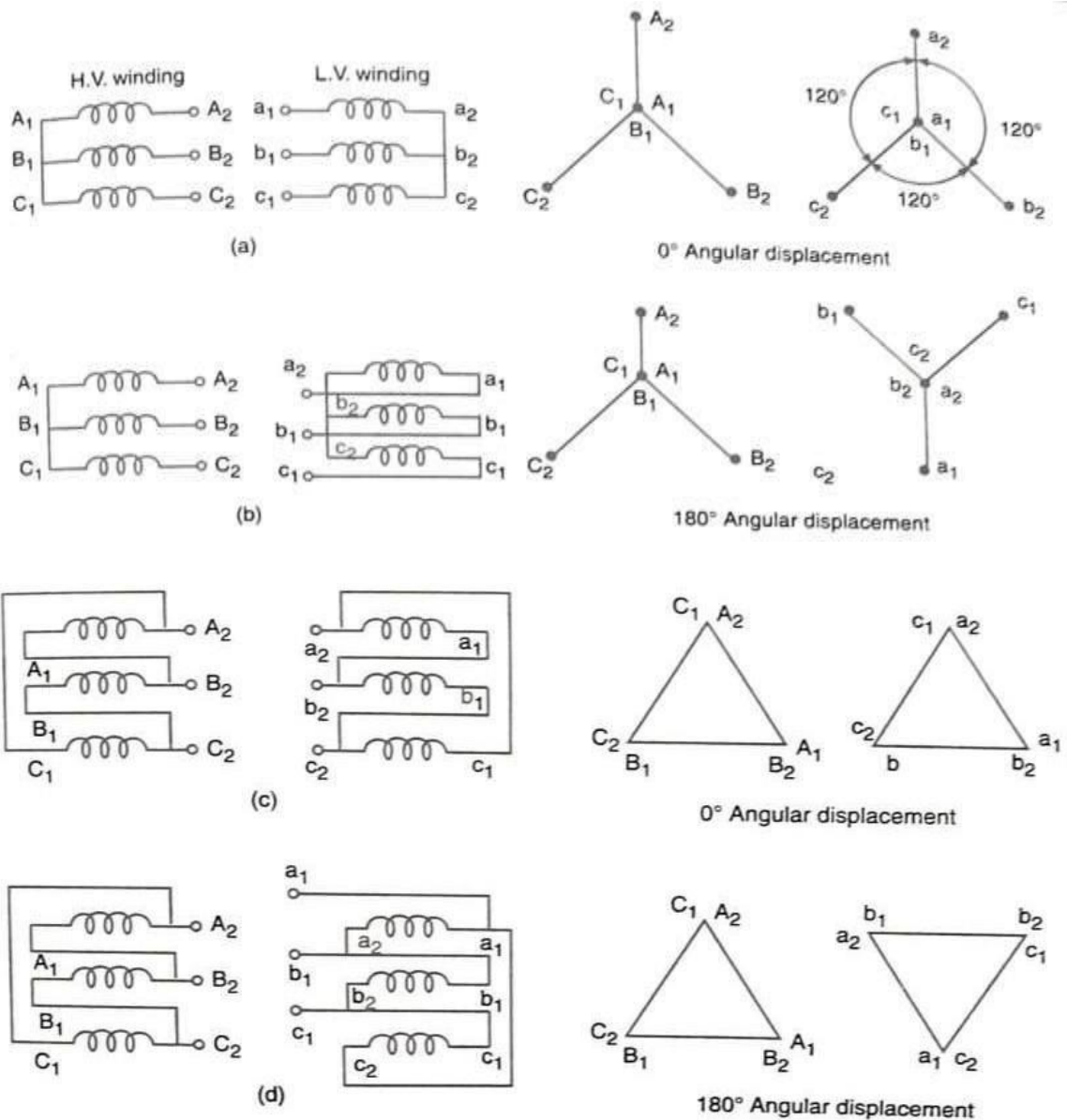

Transformer winding connections (a) Y_{y0} (b) Y_{y6} (c) D_{d0} (d) D_{d6}

The phase displacement is indicated by the angle in terms of clock face. The H.V. vector being at 12'o' clock (zero) and corresponding L.V. vector at hour hand number thus,

Phase displacement $0^\circ = 0$

Phase displacement 180° lag = 6

Phase displacement 30° lag = 1

Phase displacement 30° lead = 11

Letter Y represents star connected H.V.

Letter y represents star connected L.V.

Letter D represents delta connected H.V.

Letter d represents delta connected LV.

Letter Z represents star connected zig-zag.

Thus the symbol Y_{y0} represents a star/star winding with 0° displacement.

The phase difference between high voltage (H.V.) and low-voltage (L.V.) windings for different types of connections can be represented by comparing it with the hour hand of a clock.

When the hour hand of the clock is at the 12 o'clock position it is considered zero displacement. When it is at the 11 o'clock position the displacement is $+30^\circ$ i.e., anticlockwise is positive. When the hand is the 1 o'clock position the displacement is -30° and at the 6 o'clock position it is 180° .

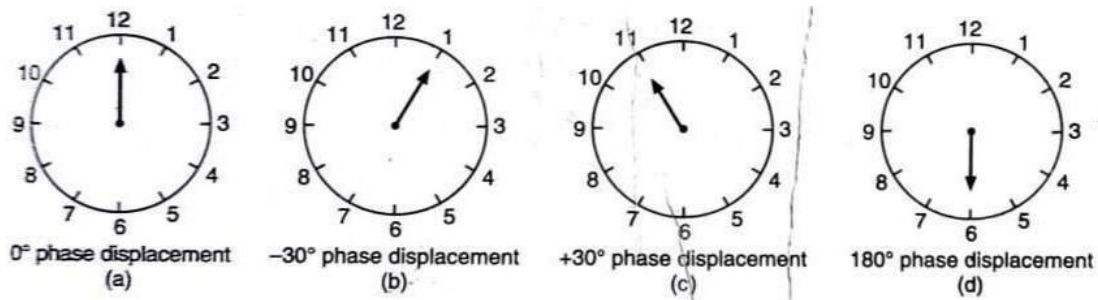

Transformers are classified in 4 vector groups 1, 2, 3, 4 depending upon the phase displacement.

Group	0 clock	Transformer connection
Group I	0 'o' clock, 0°	delta/delta, star/star
Group II	6 'o' clock 180°	delta/delt, star/star
Group III	1'o' clock -30°	star/delta, delta/star
Group IV	11 o' clock $+30^\circ$	star/delta, delta/star

Minus sign indicates LV lagging HV and plus sign indicates LV leading HV.

Winding Connection Designations

- i. First symbol: For High voltage -> Always Capital Letters
D= Delta, Y = Star, Z- Interconnected star, N- Neutral
- ii. Second Symbol: For low voltage -> Always small letter d = delta, y = star, z - Interconnected star, n = neutral
- iii. Third symbol: Phase displacement expressed as the clock hour number (1, 6, 11)
Example- Dyn 11.

Types of 3-Phase Transformer Connections:

According to inter-connection of three primary and three secondary windings, three phase transformers may be classified into following four categories:

The main four connection are:

1. Star-star connection
2. Delta-delta connection

3. Delta-star connection
4. Star-delta connection

Star-Star (Y/Y) Connection:

In this type, the primary and secondary sides both are connected in star fashion. This connection is most economical for small, high-voltage transformers because the number of turns/phase and the amount of insulation required is minimum (as phase voltage is only of $\frac{1}{\sqrt{3}}$ line voltage).

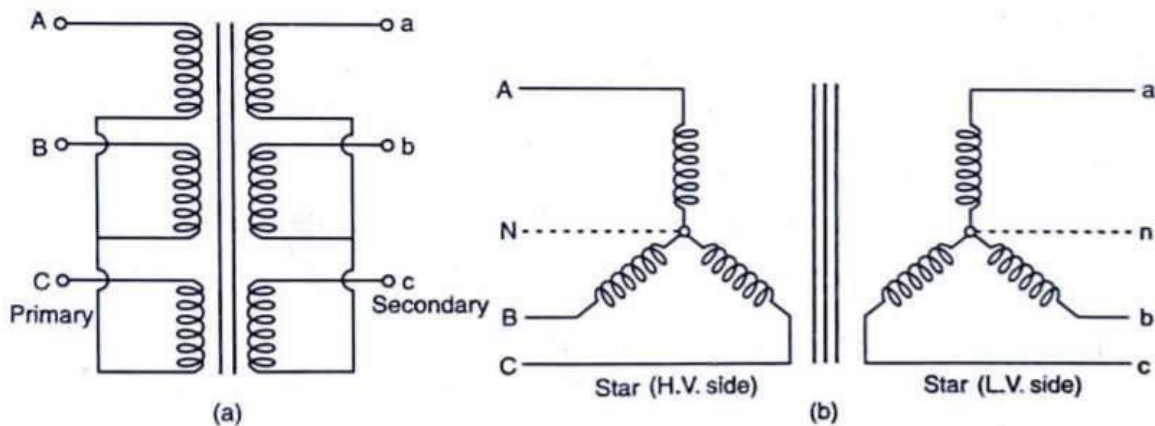

Star-star connection

Advantages:

- (i) The phase voltage is $\frac{1}{\sqrt{3}}$ times the line voltage, so fewer number of turns are required. Hence this type of transformer is cheaper.
- (ii) Since primary and secondary windings both are connected in star, so there is no phase shift between primary and secondary winding.
- (iii) The windings have higher current, so more cross-section of the winding conductor and thus it can be as heavy loads.

Disadvantages:

- (i) If the primary neutral is not connected to the source unbalanced load causes a moving neutral.
- (ii) Phase voltage on load side changes unless neutral point is earthed on an unbalanced load.
- (iii) Transformer draws magnetising current consisting of third harmonic. If the neutral of the primary is not connected with the neutral of generator, magnetising current gets reduced and flux in the core is not sinusoidal leading to the distorted output emf.

Delta-Delta (Δ - Δ) Connection:

In this type of transformer groups of winding of a 3-phase transformer are connected in delta on primary side and secondary side. These types of connections are more suitable for large transformers working on low voltage and high current. It has only disadvantage that no neutral is available. The cross-section of the wire is reduced as the phase current is $\frac{1}{\sqrt{3}}$ times the line current.

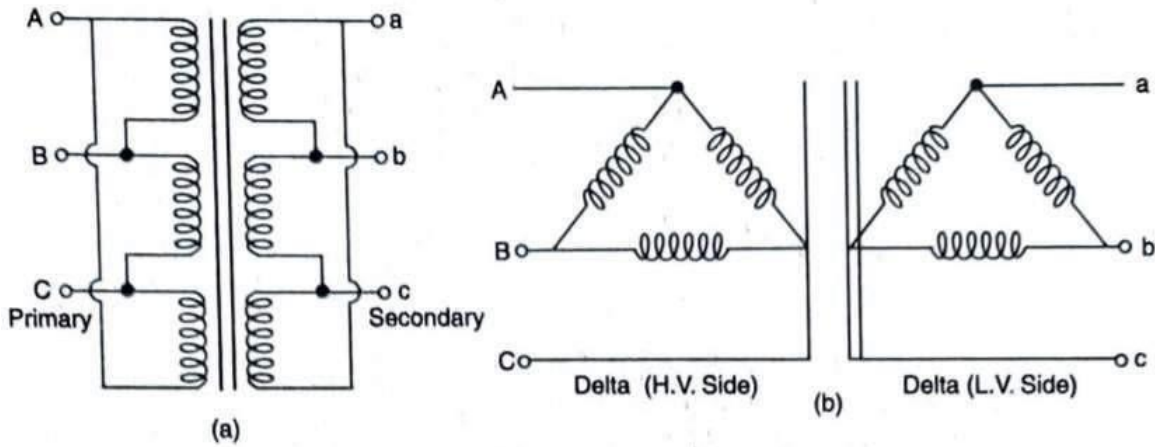

Delta-Delta connection

Advantages:

- (i) Current in winding is reduced to $\frac{1}{\sqrt{3}}$ of line current, therefore, cross-sectional area of conductor reduces.
- (ii) Unbalanced loads do not effect much.
- (iii) No phase displacement between the primary and secondary.
- (iv) Third harmonic can flow easily in Δ - Δ connections, therefore, sinusoidal voltages are obtained.

Disadvantages:

- (i) In this system neutral point is not available. Therefore, 3-phase 4 wire connections are not possible secondly because $V_L = V_P$ hence for higher voltage heavy insulation has to be provided. (ii) The absence of star point is a disadvantage.

Delta-Star(Δ -Y) Connection:

In this type of 3-phase transformer primary is connected in delta fashion and secondary as star.

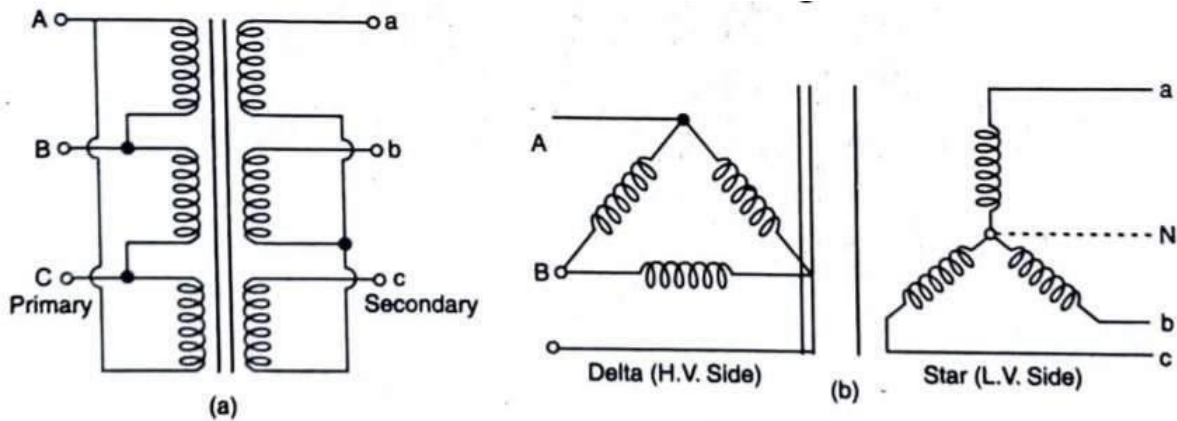

Delta-star Connection

The delta-star connection is very popular at sub-station in power system for changing the voltage level. The Δ -Y connection is commonly used for stepping up to a high voltage. In such cases the star winding supplies 3-phase, 4-wire distributors and delta winding is connected to the input side i.e. primary. This connection is generally employed at the beginning of high tension transmission system.

Advantages:

- (i) Neutral can be brought out for grounding. This facilitates the use of 3-phase, 4-wire system of distributions which is economical.
- (ii) Because in the secondary side voltage per phase is reduced to $\frac{1}{\sqrt{3}}$ of the line voltage, therefore, insulation reduced.

Star-Delta (Y- Δ) Connection:

When the primaries are connected in star and secondaries in delta the transformer is known as star-delta transformer.

On the primary side the line voltage is $\sqrt{3}$ times the phase voltage, while the line and phase voltages are equal on secondary side. Generally the H.V. winding is star connected to result in saving in cost of insulation. Such types of transformers are used for stepping down the voltage at receiving end sub-stations.

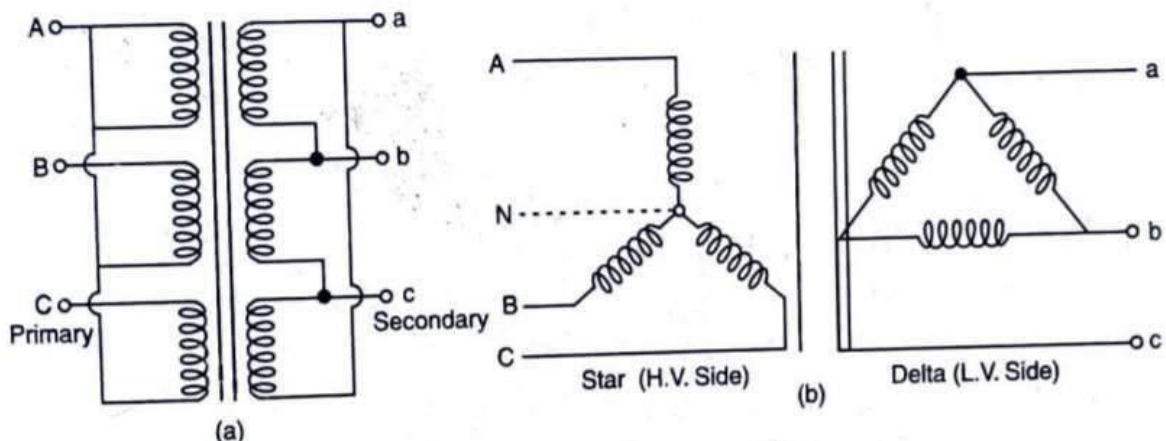

Star-Delta connection

Advantages:

This type of connections is suitable for stepping down a high voltage. Neutral of primary is earthed.

Disadvantages:

The disadvantage of this connection is that if one of the bank becomes faulty, the feeder or distributor becomes inoperative. Moreover because phase difference of 30° between the primary and secondary line voltage, the combination cannot be operated in parallel with delta-delta or star-star.

Parallel operation of the three phase transformers:

All the conditions for the successful parallel operation of single phase transformers also apply to the parallel running of 3-phase transformers but with the following additions:

- (i) The secondaries of all transformers must have the same phase sequence.
- (ii) The phase displacement between primary and secondary line voltages must be the same for all transformers which are to be operated in parallel. For this, transformers in the same group should be connected in parallel.
- (iii) The secondaries of all transformers must have the same magnitude of line voltage.

The above three conditions must be strictly observed. If these conditions are not complied with, the secondaries will simply short-circuit one another and no output will be possible.

Possible parallel operations

Sl. No.	Transformer-I	Transformer-II
1	Y/Y	Δ/Δ
2	Y/ Δ	Δ/Y
3	Δ/Y	Y/ Δ
4	Y/Y	Y/Y
5	Δ/Δ	Δ/Δ

Tap Changing Transformers:

The change of voltage is affected by changing the numbers of turns of the transformer provided with taps. For sufficiently close control of voltage, taps are usually provided on the high voltage windings of the transformer.

Tappings are also provided for one of the following reasons

- a) For varying secondary voltage.
- b) For maintaining the secondary side constant with a varying primary voltage.

- c) For providing a neutral point e.g., for earthing.
- d) For providing the required voltage for special purpose, such as lighting.

There are two types of tap-changing transformers

1. No load or Off-load tap changing transformer
2. On-load tap changing transformer

No load or Off-load tap-changing transformer:

The cheapest method of changing the turn ratio of a transformer is the use of no-load or off load tap changer. Off load tap changing is normally provided in low power, low voltage transformers.

In this method, the transformer is disconnected from the main supply when the tap setting is to be changed. Such adjustments are made for seasonal load variations. Off load tap-changer operation is manually executed by substation operator. Daily and short- time voltage control is not possible by off circuit tap switch.

Precautions: Off load tap changer is never operated on load. If by chance it would be operated on load, there would be heavy sparking at the stud. When the arm is lifted from them resulting in damage of transformer winding and the tap changer.

On-load tap changing transformer:

On load tap-changer is that type of tap changer in which the voltage can be regulated while transformer is delivering normal load. The daily voltage variation due to changing load and short period voltage variations are controlled by on load tap changer automatically.

In order that the supply may not be interrupted, on-load tap changing transformer is used. Such a transformer is known as a tap-changing under load transformer.

With the introduction of On-load tap changer, the operating efficiency of the electrical system gets considerably improved.

While tapping, two essential conditions are to be fulfilled.

- The load circuit should not be broken to avoid arcing and prevent the damage of contacts.
- No parts of the windings should be short-circuited while adjusting the tap.

There is not fixed rule regarding placing the tap-changer on primary and secondary. It is generally desirable to locate the tap-changer on H.V. winding because of smaller current.

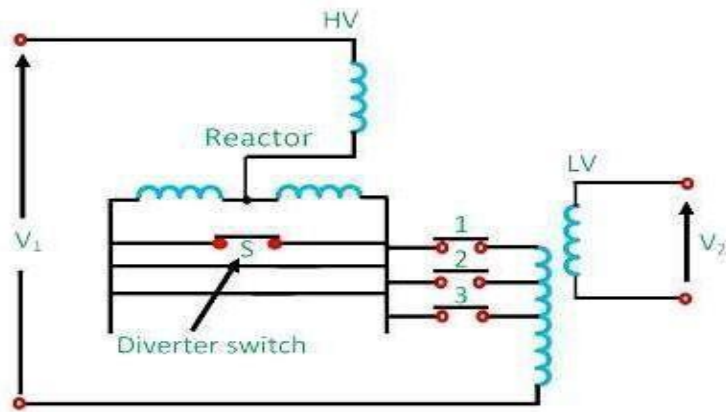

On-load tap changing using a reactor

The tap changing employing a centre tapped reactor R show in the figure. Here S is the diverter switch, and 1, 2, 3 are selector switch. The transformer is in operation with switches 1 and S closed. To change to tap 2, switch S is opened, and 2 is closed. Switch 1 is then opened, and S closed to complete the tap change. The diverter switch operates on load, and no current flows in the selector switches during tap changing. On-load tap-changer is provided with a centre tapped reactor to prevent the short circuiting of the tapped winding during the tap changing operation.

On-load tap-changing is also useful in industrial applications where variable voltage is required for certain process.

Precautions: Never open the main circuit during the operation of tap-changer otherwise dangerous sparking will occur.