



GOVERNMENT POLYTECHNIC, BHUBANESWAR
Government of Odisha
ସରକାରୀ ବହୁବୃତ୍ତି ଅନୁଷ୍ଠାନ, ଭୁବନେଶ୍ୱର

**DIGITAL
CONTENT
OF
RENEWABLE
ENERGY**

PREPARED BY- LIPIPUSPA BEHERA

Ch. 1- Energy Situation and Renewable Energy Sources

Definition of Renewable Energy :

You have already known about non-renewable or exhaustible sources of energy. Most of us rely heavily on the use of non-renewable energy resources such as coal, oil and natural gas for our daily need but we know that these resources are finite in nature and eventually the day will come when they will vanish for ever. Before that they will become too expensive and also damaging for the environment. Sooner or later we have to think about using alternative energy resources which are renewable, may last forever.

The increasing population and change in our life style make great demand for energy resources. This ever increasing demand puts great pressure on non-renewable conventional energy sources and makes it necessary that we should look for other alternative energy resources. The sources like sun and wind can never be exhausted and are thus known as renewable sources of energy; they cause no emission of poisonous gases and are available locally. They are widely available and potential source of clean and limitless sources of energy. In this lesson you will study about such renewable sources of energy.

Classification of Energy:

I. Commercial Energy and Non Commercial Energy:

Commercial Energy:

The energy sources that are available in the market for a definite price are known as commercial energy. By far the most important forms of commercial energy are electricity, coal and refined petroleum products. Commercial energy forms the basis of industrial, agricultural, transport and commercial development in the modern world. In the industrialized countries, commercialized fuels are predominant source not only for economic production, but also for many household tasks of general population. Examples: Electricity, lignite, coal, oil, natural gas etc.

Non-Commercial Energy:

The energy sources that are not available in the commercial market for a price are classified as non-commercial energy. Non-commercial energy sources include fuels such as firewood, cattle dung and agricultural wastes, which are traditionally gathered, and not bought at a price used especially in rural households. These are also called traditional fuels. Non-commercial energy is

often ignored in energy accounting. Example: Firewood, agro waste in rural areas; solar energy for water heating, electricity generation, for drying grain, fish and fruits; animal power for transport, threshing, lifting water for irrigation, crushing sugarcane; wind energy for lifting water and electricity generation.

II. Conventional and Non-conventional energy resources:

Conventional Energy:

Conventional energy resources which are being traditionally used for many decades and were in common use around oil crisis of 1973 are called conventional energy resources, e.g., fossil fuel, nuclear and hydro resources.

Non-conventional energy:

Non-conventional energy resources which are considered for large – scale use after oil crisis of 1973, are called non-conventional energy sources, e.g., solar, wind, biomass, etc.

III. Renewable and Non-Renewable Energy:

Renewable energy is energy obtained from sources that are essentially inexhaustible. Examples of renewable resources include wind power, solar power, geothermal energy, tidal power and hydroelectric power. The most important feature of renewable energy is that it can be harnessed without the release of harmful pollutants. Non-renewable energy is the conventional fossil fuels such as coal, oil and gas, which are likely to deplete with time.

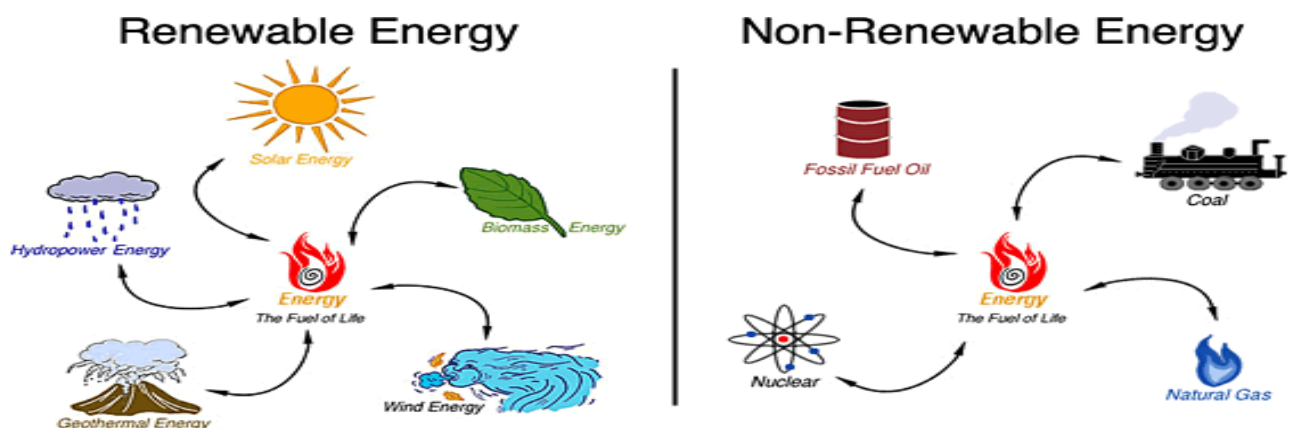

Energy and Environment

The usage of energy resources in industry leads to environmental damages by polluting the atmosphere. Few of examples of air pollution are sulphur dioxide (SO₂), nitrous oxide (NO_x) and carbon monoxide (CO) emissions from boilers and furnaces, Chloro fluoro carbons (CFC) emissions from refrigerants use, etc. In chemical and fertilizers industries, toxic gases are released. Cement plants and power plants spew out particulate matter.

Air Pollution

A variety of air pollutants have known or suspected harmful effects on human health and the environment. These air pollutants are basically the products of combustion from fossil fuel use. Air pollutants from these sources may not only create problems near to these sources but also can cause problems far away. Air pollutants can travel long distances, chemically react in the atmosphere to produce secondary pollutants such as acid rain or ozone.

Sulphur dioxide is a corrosive acid gas, which combines with water vapour in the atmosphere to produce acid rain. Both wet and dry depositions have been implicated in the damage and destruction of vegetation and in the degradation of soils, building materials and watercourses. SO₂ in ambient air is also associated with asthma and chronic bronchitis. The principal source of this gas is power stations and industries burning fossil fuels, which contain sulphur.

Nitrogen oxides are formed during high temperature combustion processes from the oxidation of nitrogen in the air or fuel. The principal source of nitrogen oxides - nitric oxide (NO) and nitrogen dioxide (NO₂), collectively known as NO_x is road traffic. NO and NO₂ concentrations are greatest in urban areas where traffic is heaviest. Other important sources are power stations and industrial processes.

Acidification from SO₂ and NO₂

Acidification of water bodies and soils, and the consequent impact on agriculture, forestry and fisheries are the result of the re-deposition of acidifying compounds resulting principally from the oxidation of primary SO₂ and NO₂ emissions from fossil fuel combustion. Deposition may be by either wet or dry processes, and acid deposition studies often need to examine both of these acidification routes.

Carbon monoxide (CO) is a toxic gas, which is emitted into the atmosphere as a result of combustion processes, and from oxidation of hydrocarbons and

other organic compounds. In urban areas, CO is produced almost entirely (90%) from road traffic emissions. CO at levels found in ambient air may reduce the oxygen-carrying capacity of the blood. It survives in the atmosphere for a period of approximately 1 month and finally gets oxidized to carbon dioxide(CO₂).

Ground-level ozone (O₃), unlike other primary pollutants mentioned above, is not emitted directly into the atmosphere, but is a secondary pollutant produced by reaction between nitrogen dioxide (NO₂), hydrocarbons and sunlight. Ozone can irritate the eyes and air passages causing breathing difficulties and may increase susceptibility to infection. It is a highly reactive chemical, capable of attacking surfaces, fabrics and rubber materials. Ozone is also toxic to some crops, vegetation and trees.

Hydrocarbons:

There are two main groups of hydrocarbons of concern: volatile organic compounds (VOCs) and polycyclic aromatic hydrocarbons (PAHs). VOCs are released in vehicle exhaust gases either as unburned fuels or as combustion products, and are also emitted by the evaporation of solvents and motor fuels. Benzene and 1,3-butadiene are of particular concern, as they are known carcinogens. Other VOCs are important because of the role they play in the photochemical formation of ozone in the atmosphere.

Benzene is an aromatic VOC, which is a minor constituent of petrol (about 2% by volume). The main sources of benzene in the atmosphere are the distribution and combustion of petrol. Of these, combustion by petrol vehicles is the single biggest source (70%oftotalemissions). Whilst the refining, distribution and evaporation of petrol from vehicles accounts for approximately a further 10% of total emissions. Benzene is emitted in vehicle exhaust not only as sunburnt fuel but also as a product of the decomposition of other aromatic compounds. Benzene is a known human carcinogen.

TOMPs (Toxic Organic Micro pollutants) are produced by the incomplete combustion of fuels. They comprise a complex range of chemicals some of which, although they are emitted in very small quantities, are highly toxic or and carcinogenic. Compounds in this category include:

PAHs (PolyAromaticHydrocarbons),
PCBs (PolyChlorinatedBiphenyls) ,
Dioxins ,
Furans .

Heavy Metals and Lead

Particulate metals in air result from activities such as fossil fuel combustion (including vehicles), metal processing industries and waste incineration. There are currently no emission standards for metals other than lead. Lead is a cumulative poison to the central nervous system, particularly detrimental to the mental development of children.

Climatic Change:

Human activities, particularly the combustion of fossil fuels, have made the blanket of green- house gases (water vapour, carbon dioxide, methane, ozone etc.) around the earth thicker. The resulting increase in global temperature is altering the complex web of systems that allow life to thrive on earth such as rainfall, wind patterns, ocean currents and distribution of plant and animals species. Greenhouse Effect and the Carbon.

Future Effects

Even the minimum predicted shifts in climate for the 21st century are likely to be significant and disruptive. Predictions of future climatic changes are wide-ranging. The global temperature may climb from 1.4 to 5.8 degrees C; the sea level may rise from 9 to 88 cm. Thus, increases in sea level this century are expected to range from significant to catastrophic. This uncertainty reflects the complexity, interrelatedness, and sensitivity of the natural systems that make up the climate. Some of the effects are :

- Severe Storms and Flooding,
- Food Shortages,
- Dwindling Freshwater supply,
- Loss of Biodiversity,
- Increased Diseases,
- Acid rain.

Origin of Renewable Energy Sources:

Humans have always been using some source of energy for a variety of purposes - cooking, warming, ploughing, transportation, lighting etc. To start they used fire wood and later kerosene or coal or rather lately the electricity. He used animal power (horse, bullock, camel, yak etc.) for transportation and for running minor mechanical devices like the Persian wheel for irrigation or for running “kolhu” for extracting oil from oil seeds. During the last century or

so, electricity has been produced from thermal plants (using coal) or from hydroelectric plants (using water current).

We can broadly categorise the source of energy according to periods of usage as follows-

- (a) Conventional source of energy, which are easily available and have been in usage for long time.
- (b) Non conventional source of energy, that are other than the usual or that are different from those in common practice.

Most of the renewable resources of energy are directly or indirectly related to sun or solar energy. Renewable sources of energy or non-conventional energy sources include sunlight, wind, water and biomass (firewood, animal dung, crop residue, agricultural wastes, biodegradable waste from cities and towns). Energy received from sun is known as **solar energy**, energy generated by water is **hydel energy** and energy obtained from underground hot dry rocks, magma, hot water springs or natural geysers etc is called **geothermal energy**. **Tidal energy** is derived from waves and tidal waves of oceans and seas.

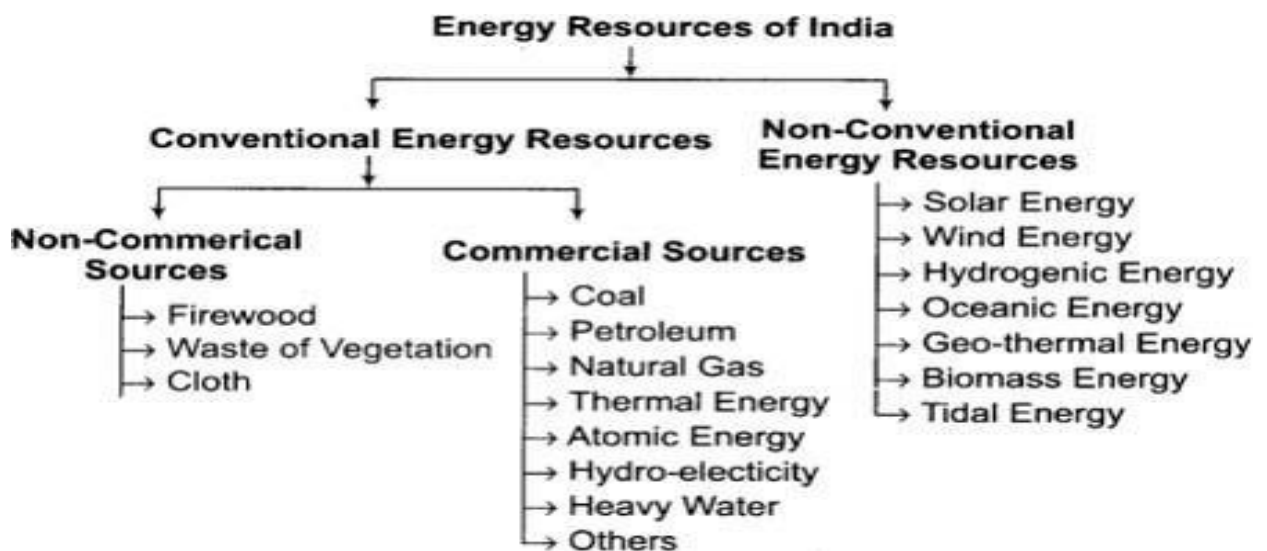

Potential of Renewable Energy Sources:

Power is one of the most crucial components for the economic growth and welfare of nations. The existence and the development of adequate power sector is essential for sustainable growth of the Indian economy. India's power sector is one of the most diversified in the world. The demand for the electricity in the country has increased rapidly and is expected to grow further

in the coming years. In order to meet this increasing demand for electricity in the country, massive addition to the installed generating capacity is required. There has been a visible impact of renewable energy in the Indian economy during the last five years. Renewable energy sector in India has experienced tremendous changes in the policy framework during the last few years. Mainly, the Solar energy and Wind energy sectors are experiencing accelerated and ambitious plans to increase the contribution of these sectors out of the total energy contribution in India.

India has an estimated renewable energy potential of about 900 GW from sources like Wind – 102 GW, Bio-energy – 25 GW, Small Hydro – 20 GW and Solar power – 750 GW. Renewable energy enjoys 15.90% shares in total installed capacity in India. As of March 2017, renewable energy installed capacity totalled to 57,260 MW. Renewable energy has been witnessing over 20% growth in the last five years. From the total renewable power installed capacity of 14,400 MW at the beginning of 2009, it has increased to the capacity of 38,822 MW at the end of December, 2015 to 57,260MW by March, 2017. Wind energy continues to dominate India's renewable energy industry accounting for 29151.29 MW by March, 2017 from 25,088 MW by December, 2015.

Renewable power installed capacity has steadily increased over the time. Wind power in fact holds the dominant position in current installed capacity in total renewable power installed capacities. There has been a constant growth in the capacities in India during the financial year 2007-15 which is shown in figure 1.0. ranging from 9389 MW in 2007 to 34,351MW in 2015. Wind Power and Solar power dominates the total renewable energy potential in India taking the states altogether. Estimates of wind energy potential indicate that its potential is much higher across Gujarat and Tamil Nadu. Whereas, the solar energy potential indicate that its potential is much higher across Jammu and Kashmir and Andhra Pradesh.

Ch.2- Solar radiation & Collectors

Solar Radiation Through Atmosphere:

Solar energy, received in the form of radiation, can be converted directly or indirectly into other forms of energy, such as heat and electricity. The major drawbacks of the extensive application of solar energy are

1. the intermittent and variable manner in which it arrives at the earth's surface and
2. the large area required to collect the energy at a useful rate.

Energy is radiated by the sun as electromagnetic waves of which 99% have wavelengths in the range of 0.2 to 4.0 micrometers (1 micrometer = 10^{-6} meter)

Solar energy reaching the top of the earth's atmosphere consists of about

- 8% ultra violet length >0.39
- 46% visible micrometer]
- 46% infrared

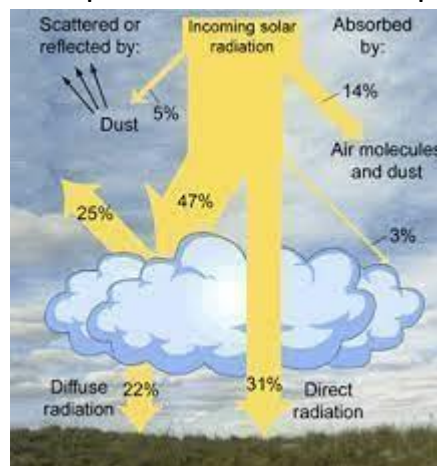

radiation [short wave micrometer]

light [0.39 to 0.78

[0.78 micrometer above]

About 29 percent of the solar energy that arrives at the top of the atmosphere is reflected back to space by clouds, atmospheric particles, or bright ground surfaces like sea ice and snow. This energy plays no role in Earth's climate system. About 23 percent of incoming solar energy is absorbed in the atmosphere by water vapor, dust, and ozone, and 48 percent passes through the atmosphere and is absorbed by the surface. Thus, about 71 percent of the total incoming solar energy is absorbed by the Earth system.

Of the 340 watts per square meter of solar energy that falls on the Earth, 29% is reflected back into space, primarily by clouds, but also by other bright surfaces and the atmosphere itself. About 23% of incoming energy is absorbed in the atmosphere by atmospheric gases, dust, and other particles. The remaining 48% is absorbed at the surface.

Terrestrial Solar Radiation:

Measurement of Solar Radiation:

The measurement of solar radiation is performed with the help of sunshine recorders, Pyranometres and Pyrhemimeters.

Sunshine recorder:

The instrument measures the duration in hours of bright sunshine during the course of a day. It consists of a glass sphere (about 10 cm in diameter) mounted on its axis parallel to that of the earth within a spherical section (bowl). The bowl and glass sphere are arranged in such a way that the sun's rays are focused sharply at a spot on a card held in a groove in the bowl. As the sun moves, the focused bright sunshine burns a path along this paper. The length of the trace thus obtained on the paper is the measure of the duration of the bright sunshine.

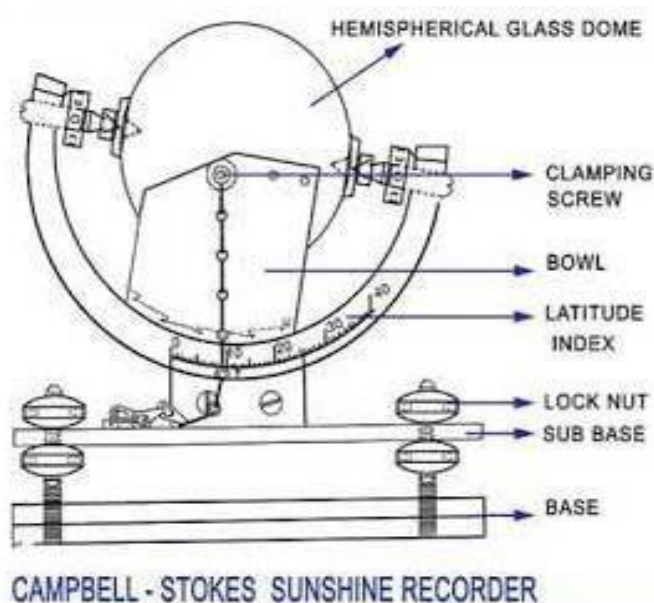

Pyranometres:

A precision pyranometer is designed to respond all wave lengths of radiation and hence measures accurately the total power in the incident spectrum. It contains a thermo pile whose sensitive surface consists of circular,blackened,hot junctions exposed to the sun. The cold junction being completely shaded. The temperature difference between the hot and cold junctions is the function of radiation falling on the sensitive surface. The sensing element is covered with two concentric hemi spherical glass domes to protect from rain and wind. A radiation shield surrounding the outer dome and coplanar with the sensing element, prevents direct solar radiation from the base of the heating element.

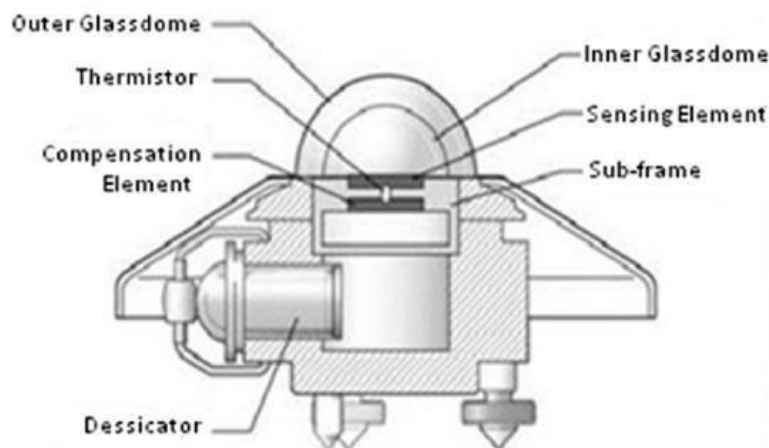

Pyrheliometers:

The long collimator tube collects the beam radiation whose field of view is limited to a solid angle of 5.50 . The diaphragms are present inside the tube. The inside of the tube is blackened to absorb any radiation incident at angles outside the collection solid angle. At the base of the tube a wire wound thermo pile having a sensitivity of approximately $8\mu\text{ W/m}^2$ and an output impedance of approximately 200Ω is provided. The tube is sealed with dry air to eliminate absorption of beam radiation within the tube by water vapour.

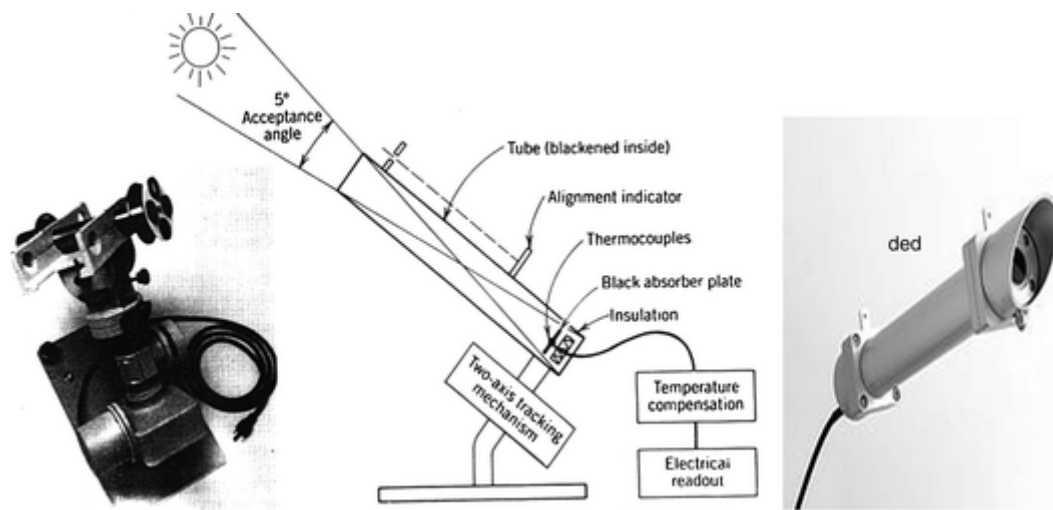

Solar Collectors:

Solar thermal energy is the most readily available source of energy. The Solar energy is most important kind of non-conventional source of energy which has been used since ancient times, but in a most primitive manner. The abundant solar energy available is suitable for harnessing for a number of applications. The application of solar thermal energy system ranges from solar cooker of 1 kw to power plant of 200MW. These systems are grouped into low temperature (<150oC), medium temperature (150-300oC) applications.

Solar collectors are used to collect the solar energy and convert the incident radiations into thermal energy by absorbing them. This heat is extracted by flowing fluid (air or water or mixture with antifreeze) in the tube of the collector for further utilization in different applications. The collectors are classified as;

Solar Thermal Collectors

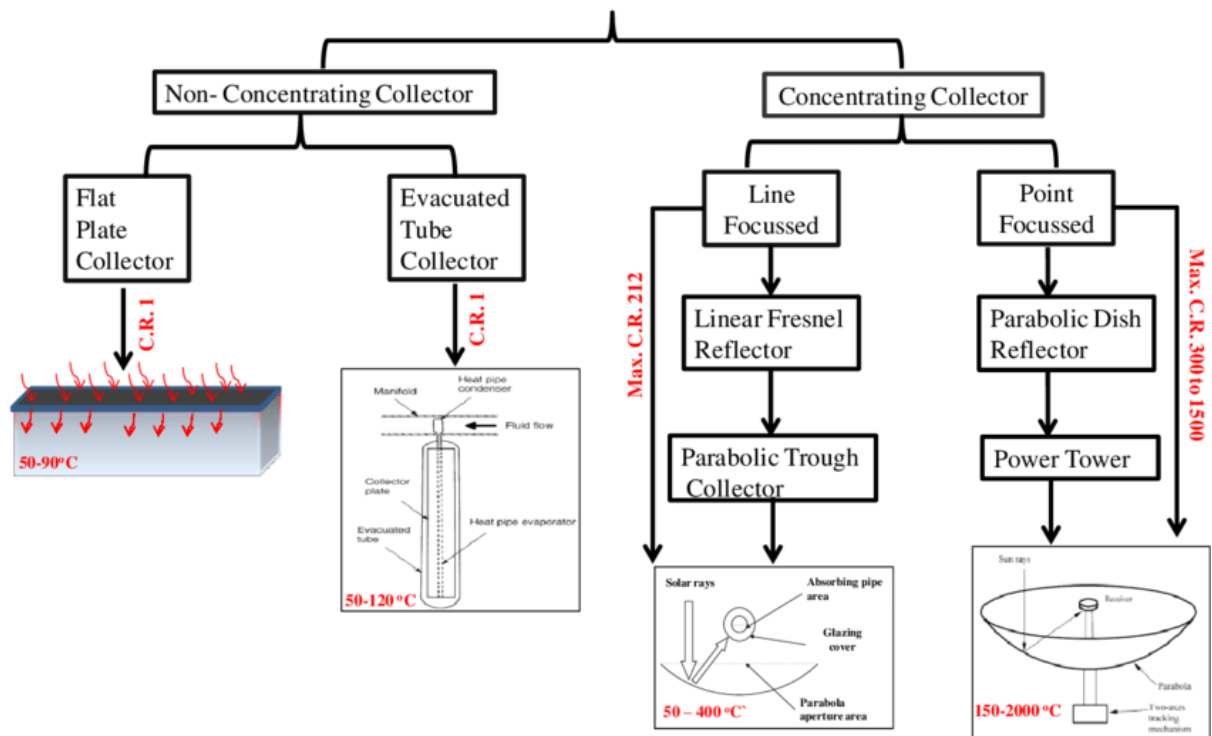

Flat Plate Collectors:

The flat plate collector is located in a position such that its length is aligned with longitude and is suitably tilted towards south to have maximum collection. The schematics of flat plate collectors are shown in the figure (a) and (b). It consists of a black coated plate made of metal or plastic, which absorbs all the solar radiation incident on it and converts into heat. This plate is known as the absorber. Fluid channels are welded below the absorber for carrying a heat transfer fluid generally water. This transport fluid transports the heat from the absorber into the utilisation purposes.

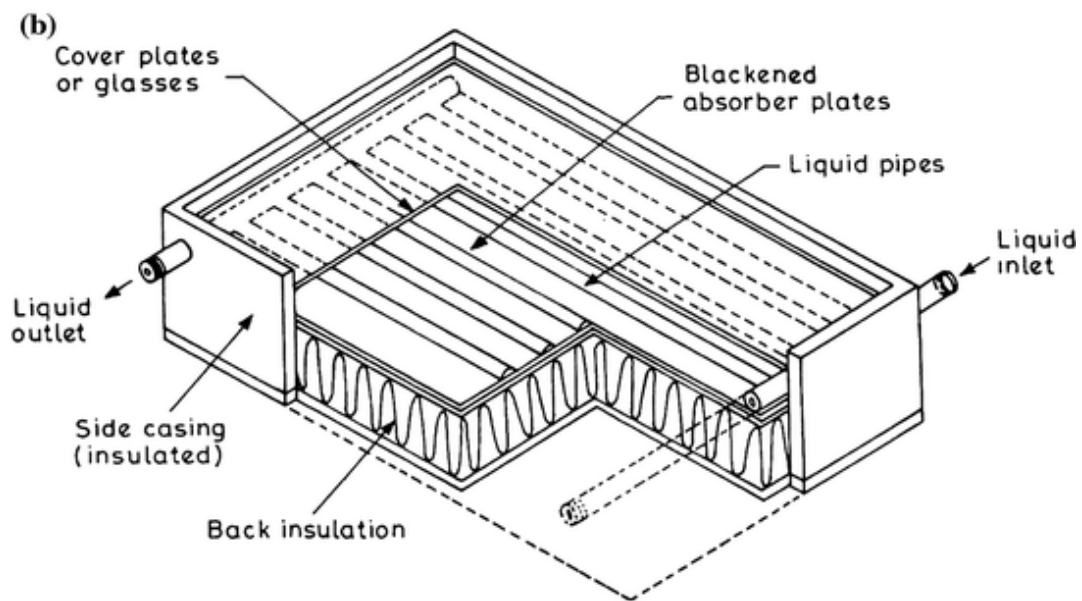
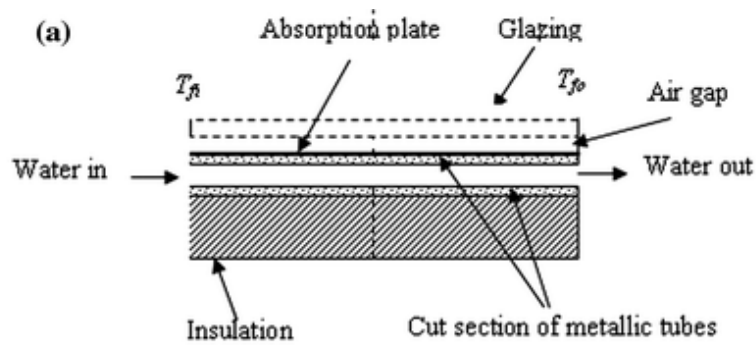
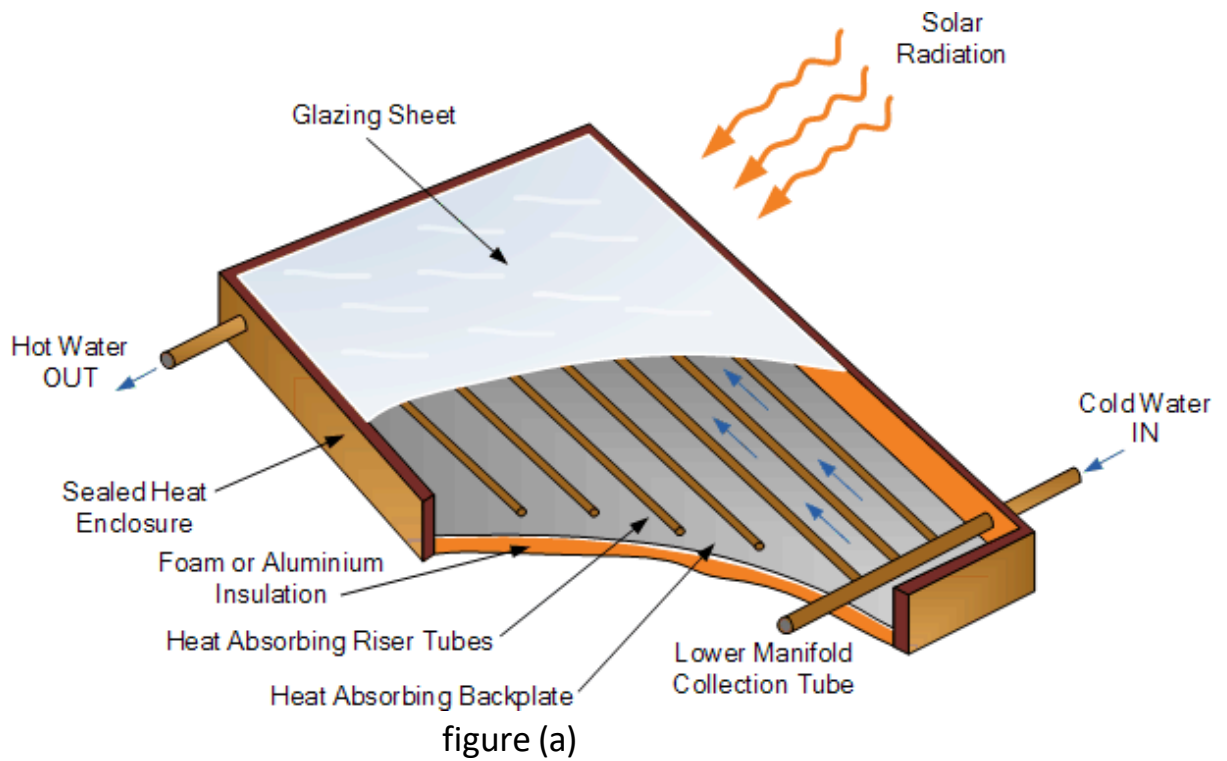

Figure (b)

To reduce the heat losses, the back side and sides of the collector (below the absorber) are covered with insulation. The front above of the absorber is covered with one or two transparent glass sheets. The whole thing is sealed in a box or some sort of casing. The working of the collector basically depends upon the greenhouse effects. Flat plate collectors can convert solar radiation into heat upto maximum 100°C. Air heating solar collectors are mostly used for agricultural drying and space heating applications. The basic advantages are low sensitivity to leakage, less corrosion and no need for additional heat exchanger. The main disadvantage is the requirement of larger surface area for heat transfer and higher flow rate.

Ch. 3- Low-Temperature Applications of Solar Energy.

The easiest and most direct application of solar energy is the direct conversion of sunlight into low-temperature heat - up to a temperature of 100 degrees Celsius. In general, two classes of technologies can be distinguished: passive and active solar energy conversion. With active conversion there is always a solar collector, and the heat is transported to the process by a medium. With passive conversion the conversion takes place in the process, so no active components are used.

Solar domestic hot water systems.

The solar domestic hot water system (SDHW) consists of three components: a solar collector panel, a storage tank, and a circulation system to transfer the heat from the panel to the store. SDHW systems for household range in size, because of differences in hot water demands and climate conditions. In general price/performance analysis will be made to size the solar hot water system and to investigate the optimum solar fraction (contribution of solar energy in energy demand). The results show a general dependence on the climate. The SDHW systems in Northern and Central Europe are designed to operate on a solar fraction of 50 - 65 percent. Subtropical climates generally achieve solar fractions of 80 - 100 percent. Table 7.16 indicates typical characteristics of applied systems in various climate zones in Europe.

Pump/circulation systems are generally used in climate zones with a serious frost and overheating danger. These systems either use the drain-back principle (the fluid drains from the collector if there is no solar contribution) or an antifreeze additive in the collector fluid. In countries with a warmer climate, natural circulation systems are mostly used. Almost all collectors installed are of the flat plate type. But in China in 1997 about 2 million evacuated tube collectors (about 150,000 square metres of collector area) were produced (Morrison, 1999). These are double-walled concentric glass tubes, of which the enclosed space is evacuated. In regions with high solar irradiation, the use of SDHW systems may result in solar heat production costs ranging from \$0.03 - 0.12 a kilowatt-hour.

In regions with relatively low solar irradiation, the costs may range from \$0.08 - 0.25 a kilowatt-hour. In many areas these costs can be competitive with electricity prices - but in most cases not with fossil fuel prices. Further cost reductions are therefore required.

One approach is the use of complete prefabricated systems or kits, leaving no possibility to make changes in the system design, thus simplifying the installation work and reducing both the hardware and the installation cost.

Another approach, in Northern Europe, is the development of solar thermal energy markets on a large scale, to reduce production, installation, and overhead costs. As demonstrated in the Netherlands, large projects can reduce the installed system price by 30 - 40 percent relative to the price of individually marketed systems.

Cost reductions can also be achieved by further development of the technology (including integration of collector and storage unit). As a result of these approaches, solar heat production costs may come down 40 - 50 percent (TNO, 1992).

SDHW systems are commonly produced from metals (aluminium, copper, steel), glass and insulation materials. In most designs the systems can easily be separated into the constituent materials; all metals and glass can be recycled. The energy payback time of a SDHW system is now generally less than one year (van der Leun, 1994).

Large water heating systems.

Solar thermal systems can provide heat and hot water for direct use or as pre-heated water to boilers that generate steam. Such large water heating systems find widespread use in swimming pools, hotels, hospitals, and homes for the elderly. Other markets are fertiliser and chemical factories, textile mills, dairies, and food processing units. Substantial quantities of fossil fuels or electricity can be saved through their use. But the installed collector area is rather low - around a tenth of the total installed area. It is especially low in the industrial sector, mainly because of low fossil fuel costs and relatively high economic payback times of solar systems. India provides tax benefits through accelerated depreciation on such commercial systems and also has a programme to provide soft loans to finance their installation. Within these systems about 400,000 square metres of collector area has been installed in India (TERI, 1996/97). The costs per kilowatt-hour of large water heating systems are now somewhat less than SDHW energy costs. And in the long term these costs can be reduced, probably about 25 percent, mainly by mass production.

Solar space heating.

Total world space heating demand is estimated at 50 exajoules a year. In northern climates this demand can be more than 20 percent of total energy use. Mismatch between supply and demand limits the direct contribution of solar thermal energy to the space heating of a building to a maximum of 20 percent in these regions. If seasonal storage of heat is applied, solar fractions of up to 100 percent are achievable (Fisch, 1998). Space heating systems are available as water systems and as air heating systems, with air heating systems generally cheaper. Water-based systems are usually solar combi-systems that supply domestic hot water and space heating.

Seasonal storage has mainly been applied in demonstration projects, showing its technological feasibility. The technologies are divided into large and small systems. For large systems (storage for more than 250 houses) the insulation is not so important, and duct storage or aquifer storage is possible. For small systems storage of heat in an insulated tank is the only solution to date. More advanced concepts - such as chemical storage of heat - have been proven on a laboratory scale. Storage of cold from the winter to be used in the summer has proven to be profitable, if aquifers are available in the underground.

District heating.

Solar energy can also be applied for district heating. Providing hot water and space heat, several of these systems, using a central collector area, have been realised in Denmark, Germany, and Sweden. They reach similar solar fractions as single house systems: 50 percent for hot water production and 15 percent for the total heat demand (hot water plus space heating). Some of these systems have been combined with a seasonal storage increasing the solar fraction to 80 percent for the total heat demand.

Heat pumps.

Heat pumps can generate high-temperature heat from a low-temperature heat source. Working in the opposite direction the same appliance can also be used as a cooling device. In fact most heat pumps are air conditioners that are also suitable for heating purposes. Tens of millions of these appliances have been installed world-wide. In colder climates there is a market for heat pumps for heating only. In Europe in 1996 around 900,000 of these pumps were installed (Laue, 1999), and the market is growing at about 10 percent a year (Bouma, 1999).

Energy (mostly electricity) is needed to operate the heat pump. Typically the heat energy output is two to four times the electrical energy input. The

low-temperature heat input can come directly or indirectly from the sun. For example, with ground-coupled heat pump systems, the surface can be seen as a cheap solar collector - and the ground beneath it as a storage system from which the low-temperature heat can be extracted. Today, however, most systems extract heat from the open air. Different systems have been tested using solar collectors as a heat source. Because heat pumps can work with low temperatures, the collectors can be cheap.

No general statement can be made about the contribution of heat pumps to savings in fossil fuel consumption and environmental emissions. But by further improving the performance of the heat pump and by using electricity from renewable sources (hydro, wind, photovoltaics), this contribution will be definitely positive.

Solar cooling.

About 30 million air conditioners are sold each year (Nishimura, 1999). Cooling with solar heat seems an obvious application, because demand for cooling and supply of solar heat are in phase. The technologies available are absorption cooling, adsorption cooling, and desiccant cooling. A standard, single-effect absorption chiller can be driven with temperatures around 90 degrees Celsius. This can be generated with standard flat plate solar collectors. Different systems have been designed and tested, but their economics turned out to be poor. As a result this field of applications has been disregarded over the last 10 years. Recently some newer cooling cycles have become available, the solar collector performance has improved, and collector prices have gone down. So solar cooling may become a feasible option (Henning, 1999).

Solar cooking.

About half the world's cooking uses firewood as the fuel, with the other half based on gas, kerosene, or electricity. In some regions cooking energy requirements place a great pressure on biomass resources while also causing considerable inconvenience and health effects to users in the collection and burning of biomass (see chapter 3). Considering that these regions also have significant levels of solar radiation, it would appear that cooking provides a significant and beneficial impact.

China and India are among several countries promoting the use of solar cookers. A simple box-type cooker and a parabolic concentrating type cooker are among the common models deployed. Efforts have also been made to develop solar cookers for institutional use. In India some 450,000 box type

cookers have been installed. The world's largest solar cooking system - capable of preparing meals for 10,000 persons twice a day - was installed in 1999 in Taleti in Rajasthan, India (TERI, 1996/97; MNCES, 1999). In China some 100,000 concentrator-type cookers have been deployed (Wentzel, 1995).

Solar cooking devices have certain limitations and can only supplement, not replace conventional fuels. A home that uses a solar cooker regularly can save a third to a half of the conventional fuel that is used for cooking. The economic payback time is usually between 2 - 4 years. The large-scale use of solar cookers, however, will also require some adjustment by users.

Solar crop drying.

The drying of agricultural products requires large quantities of low-temperature heat - in many cases, year round. Low-cost air-based solar collectors can provide this heat at collection efficiencies of 30 - 70 percent (Voskens and Carpenter, 1999). In Finland, Norway, and Switzerland hay drying is already an established technology. By 1998 more than 100,000 square metres of air collectors for drying purposes had been installed.

Ch.4- Passive Space Conditioning & Collectors

Passive Solar Design

Passive solar design refers to the use of the sun's energy for the heating and cooling of living spaces by exposure to the sun. When sunlight strikes a building, the building materials can reflect, transmit, or absorb the solar radiation. In addition, the heat produced by the sun causes air movement that can be predictable in designed spaces. These basic responses to solar heat lead to design elements, material choices and placements that can provide heating and cooling effects in a home.

Unlike active solar heating systems, passive systems are simple and do not involve substantial use of mechanical and electrical devices, such as pumps, fans, or electrical controls to move the solar energy.

Passive Solar Design Basics

A complete passive solar design has five elements:

Aperture/Collector: The large glass area through which sunlight enters the building. The aperture(s) should face within 30 degrees of true south and should not be shaded by other buildings or trees from 9a.m. to 3p.m. daily during the heating season.

Absorber: The hard, darkened surface of the storage element. The surface, which could be a masonry wall, floor, or water container, sits in the direct path of sunlight. Sunlight hitting the surface is absorbed as heat.

Thermal mass: Materials that retain or store the heat produced by sunlight. While the absorber is an exposed surface, the thermal mass is the material below and behind this surface.

Distribution: Method by which solar heat circulates from the collection and storage points to different areas of the house. A strictly passive design will use the three natural heat transfer modes- conduction, convection and radiation- exclusively. In some applications, fans, ducts and blowers may be used to distribute the heat through the house.

Control: Roof overhangs can be used to shade the aperture area during summer months. Other elements that control under and/or overheating

include electronic sensing devices, such as a differential thermostat that signals a fan to turn on; operable vents and dampers that allow or restrict heat flow; low-emissivity blinds; and awnings.

Passive Solar Heating

The goal of passive solar heating systems is to capture the sun's heat within the building's elements and to release that heat during periods when the sun is absent, while also maintaining a comfortable room temperature. The two primary elements of passive solar heating are south facing glass and thermal mass to absorb, store, and distribute heat. There are several different approaches to implementing those elements.

Direct Gain

The actual living space is a solar collector, heat absorber and distribution system. South facing glass admits solar energy into the house where it strikes masonry floors and walls, which absorb and store the solar heat, which is radiated back out into the room at night. These thermal mass materials are typically dark in color in order to absorb as much heat as possible. The thermal mass also tempers the intensity of the heat during the day by absorbing energy. Water containers inside the living space can be used to store heat. However, unlike masonry water requires carefully designed structural support, and thus it is more difficult to integrate into the design of the house. The direct gain system utilizes 60-75% of the sun's energy striking the windows. For a direct gain system to work well, thermal mass must be insulated from the outside temperature to prevent collected solar heat from dissipating. Heat loss is especially likely when the thermal mass is in direct contact with the ground or with outside air that is at a lower temperature than the desired temperature of the mass.

Indirect Gain

Thermal mass is located between the sun and the living space. The thermal mass absorbs the sunlight that strikes it and transfers it to the living space by conduction. The indirect gain system will utilize 30-45% of the sun's energy striking the glass adjoining the thermal mass.

The most common indirect gain systems is a Trombe wall. The thermal mass, a 6-18 inch thick masonry wall, is located immediately behind south facing glass of single or double layer, which is mounted about 1 inch or less in

front of the wall's surface. Solar heat is absorbed by the wall's dark-colored outside surface and stored in the wall's mass, where it radiates into the living space. Solar heat migrates through the wall, reaching its rear surface in the late afternoon or early evening. When the indoor temperature falls below that of the wall's surface, heat is radiated into the room.

Operable vents at the top and bottom of a thermal storage wall permit heat to convect between the wall and the glass into the living space. When the vents are closed at night, radiant heat from the wall heats the living space.

Passive Solar Cooling

Passive solar cooling systems work by reducing unwanted heat gain during the day, producing non-mechanical ventilation, exchanging warm interior air for cooler exterior air when possible, and storing the coolness of the night to moderate warm daytime temperatures. At their simplest, passive solar cooling systems include overhangs or shades on south facing windows, shade trees, thermal mass and cross ventilation.

Shading

To reduce unwanted heat gain in the summer, all windows should be shaded by an overhang or other devices such as awnings, shutters and trellises. If an awning on a south facing window protrudes to half of a window's height, the sun's rays will be blocked during the summer, yet will still penetrate into the house during the winter. The sun is low on the horizon during sunrise and sunset, so overhangs on east and west facing windows are not as effective. Try to minimize the number of east and west facing windows if cooling is a major concern. Vegetation can be used to shade such windows. Landscaping in general can be used to reduce unwanted heat gain during the summer.

Thermal Mass

Thermal mass is used in a passive cooling design to absorb heat and moderate internal temperature increases on hot days. During the night, thermal mass can be cooled using ventilation, allowing it to be ready the next day to absorb heat again. It is possible to use the same thermal mass for cooling during the hot season and heating during the cold season.

Ventilation:

Natural ventilation maintains an indoor temperature that is close to the outdoor temperature, so it's only an effective cooling technique when the indoor temperature is equal to or higher than the outdoor one. The climate determines the best natural ventilation strategy.

In areas where there are daytime breezes and a desire for ventilation during the day, open windows on the side of the building facing the breeze and the opposite one to create cross ventilation. When designing, place windows in the walls facing the prevailing breeze and opposite walls. Wing walls can also be used to create ventilation through windows in walls perpendicular to prevailing breezes. A solid vertical panel is placed perpendicular to the wall, between two windows. It accelerates natural wind speed due to pressure differences created by the wing wall.

In a climate like New England where night time temperatures are generally lower than daytime ones, focus on bringing in cool nighttime air and then closing the house to hot outside air during the day. Mechanical ventilation is one way of bringing in cool air at night, but convective cooling is another option.

Convective Cooling:

The oldest and simplest form of convective cooling is designed to bring in cool night air from the outside and push out hot interior air. If there are prevailing nighttime breezes, then high vent or open on the leeward side (the side away from the wind) will let the hot air near the ceiling escape. Low vents on the opposite side (the side towards the wind) will let cool night air sweep in to replace the hot air.

At sites where there aren't prevailing breezes, it's still possible to use convective cooling by creating thermal chimneys. Thermal chimneys are designed around the fact that warm air rises; they create a warm or hot zone of air (often through solar gain) and have a high exterior exhaust outlet. The hot air exits the building at the high vent, and cooler air is drawn in through a low vent.

There are many different approaches to creating the thermal chimney effect. One is an attached south facing sunroom that is vented at the top. Air is

drawn from the living space through connecting lower vents to be exhausted through the sunroom upper vents (the upper vents from the sunroom to the living space and any operable windows must be closed and the thermal mass wall of the sunroom must be shaded).