

**GOVERNMENT POLYTECHNIC  
BHUBANESWAR-23**



**DEPARTMENT OF CIVIL ENGINEERING  
LECTURE NOTES**

**Year & Semester: 3<sup>rd</sup> Year, 6<sup>th</sup> Semester**

**Subject code/Name -Th-3, Railway & Bridge Engineering  
(CET-603)**



## CONTENT

Chapter No.	Topic Name	Page No.
1	<b>Section – A : RAILWAYS</b> Introduction	2 to 3
2	Permanent way	4 to 6
3	Track materials	7 to 31
4	Geometric for Broad gauge	32 to 36
5	Points and crossings	37 to 41
6	Laying & maintenance of track	42 to 44
7	<b>Section – B: BRIDGES</b> Introductions	45 to 50
8	Bridge Site investigation, hydrology & planning	51 to 59
9	Bridge foundation	60 to 71
10	Bridge substructure and approaches	72 to 75
11	Permanent bridges	76 to 86
12	Culvert & cause ways	87 to 90

# SECTION A

## RAILWAY ENGINEERING

### INTRODUCTION

Indian Railways is an Indian state-owned enterprise, owned and operated by the Government of India through the Ministry of Railways. It is one of the world's largest railway networks.

Railways were first introduced to India in the year 1853 from Bombay to Thane, nationalized as one unit, the Indian Railways, becoming one of the largest networks in the world. IR operates both long distance and suburban rail systems on a multi-gauge network of broad, metre and narrow gauges. It also owns locomotive and coach production facilities at several places in India and are assigned codes identifying their gauge, kind of power and type of operation.

On 23 April 2014, Indian Railways introduced a mobile app system to track train schedules.

Rolling stock used on railways in the earliest days evolved from carriages and wagons which ran on highways to carry both people and bulk materials.

As railway experience was gained, the design of rolling stock also evolved. Springing, body structure, wheels and axles all are subject to varying loads and stresses, when comparing slower speeds on rough roads to much faster speeds on railways, with a comparatively smoother ride.

Railway rolling stock generally runs on hard wheels on hard rails. The wheels are not only supported by the rails but are guided by them. The only exception to this is for a small number of metros where rubber tyres have been introduced. In this case the supporting function of the rail may be separated from the guiding function.

In all cases railway rolling stock will transmit vertical, horizontal and longitudinal forces to the track and its supports. Most railways have adopted twin rails and flanged wheels. Forces are transmitted to the rail structure either by direct bearing on the rail top from the wheel tyre, or by bearing laterally through the flange, or by longitudinal friction. Potential 'overturning' forces, caused by centrifugal force on curves, coupled with wind forces on exposed locations are resisted by vertical dead weight and super-elevation or 'cant' on curves.

### Advantages of Railways

The railways offers various advantages and for the purpose of convenience, they can be described in following three categories.

#### 1. Economic Advantages

- i) Employment to people in the form of staff required for smooth working of railways.
- ii) Encouragement to commercial farming.
- iii) Increase in cost of land thereby increase of national wealth.
- iv) Industrial development and growth because of mobility of labour and raw materials.

- v) Stabilization of prices due to easy, speedy & efficient mobility of products & natural resources.
- vi) Increase in mobility of people and thereby relieving some extent the congestion of big cities.
- vii) Transporting food and clothes in times of emergencies like floods and famines etc.

2. Political Advantages

- i) Easy control of the central administration.
- ii) Development of a national mentality in the minds of people.
- iii) Migrating population on a mass scale.
- iv) Mobilizing troops and war equipments in times of war and emergencies.
- v) Unity of people of different castes, customs and religions.

3. Social Advantages

- i) Broadening the social outlook of masses as people can visit all the parts of country and be proud of this great country.
- ii) Easy access to religious places of importance.
- iii) Providing convenient and safe mode of transport.
- iv) Removal of feeling of isolation as the railway has proved to be the most safe, economic and comfortable mode of conveyance.

**Classification of Indian Railways**

Indian railway systems according to three classes:-

Class I- Railways with gross annual earnings of over Rs 50 lakhs (Rs 50,00,000).<sup>1</sup>

Class II - Railways with gross annual earnings of between Rs 10 and 50 lakhs.

Class III - Railways with gross annual earnings of under Rs 10 lakhs.

## CHAPTER-2

### Permanent way

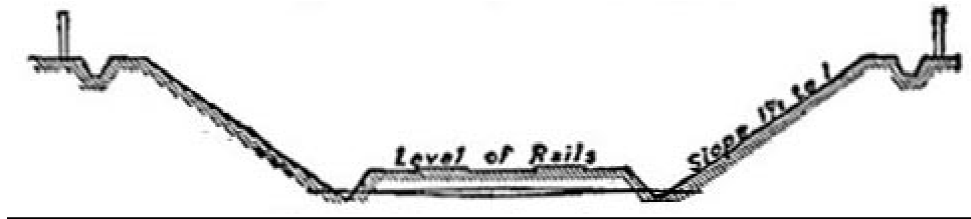

Typical Section of Railway in Cutting.

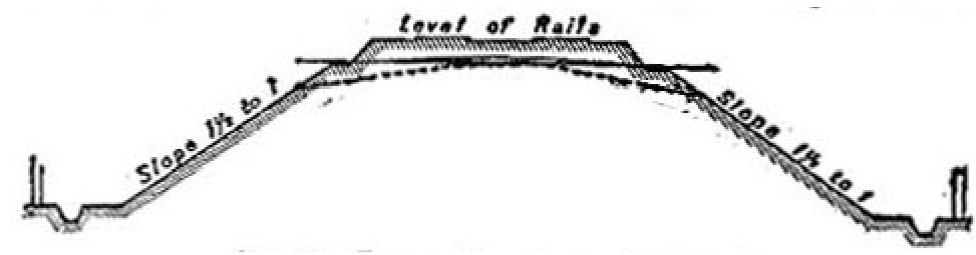

Typical Section of an embankment.

Cross section of a permanent way:

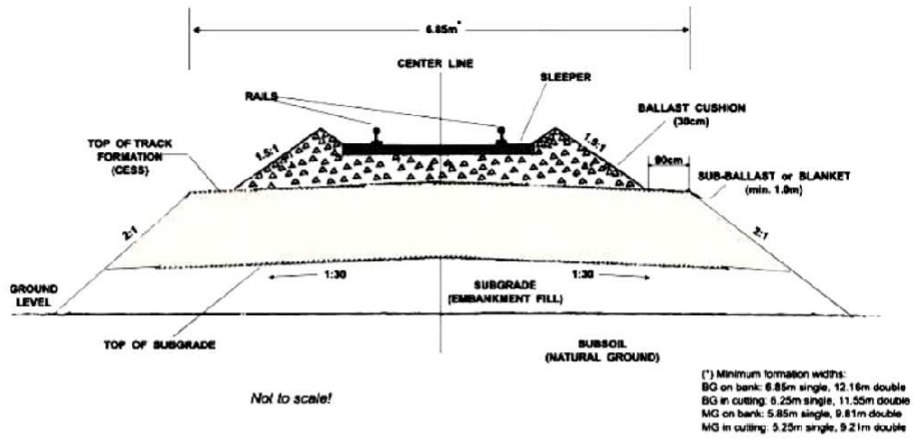

Basic functions of various components of a railway track:

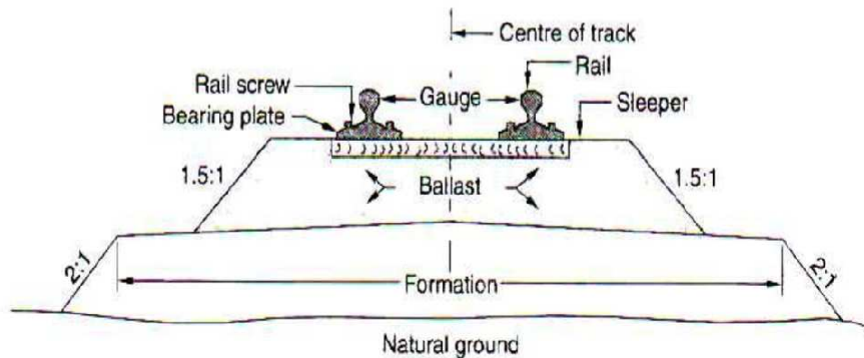

The finished or completed track of a railway line is commonly known as Permanent Way. It essentially consists of following three parts.

1. Rails
2. Sleepers
3. Ballast

The rails are fixed with each other by means of various rail fastenings and they rest on sleepers which are laid at right angles to them. The sleepers in turn rest on ballast which is spread over the formation ground prepared for the railway track.

#### **Requirements of an ideal permanent way**

1. The gauge of track should be uniform and there should not be varying gauges.
2. There should be minimum friction between the wheels of rolling stock and the rails.
3. Facilities should be provided at various points along the permanent way to repair, replace or renew the damaged portion of the track.
4. The design of the permanent way should be such that the load of the train is uniformly distributed over it.
5. The components of the permanent way should be so selected as to produce a permanent way with a certain degree of elasticity to prevent the shocks due to impact.
6. The gradient provided on the permanent way should be even and uniform.
7. The special attention should be given on the design of permanent way on curves.
8. The overall construction of the permanent way should be such that it requires minimum maintenance.
9. The permanent way should possess high resistance to damage at the time of derailment.
10. The drainage facility should be perfect.
11. The rail joints should be properly designed and maintained.
12. The precautions should be taken to avoid the occurrence of creep.
13. Various components of the permanent way should possess anti-sabotage and anti-theft qualities.

#### **Rail Gauges**

In India, the gauge of a railway track is defined as the clear minimum perpendicular distance between the inner faces of the two rails.

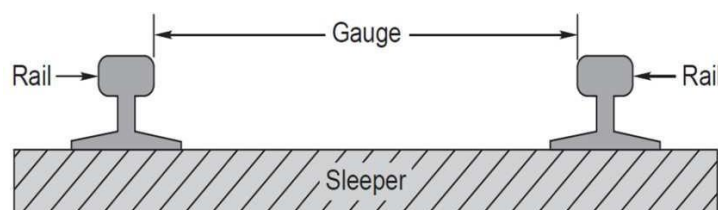

Gauge

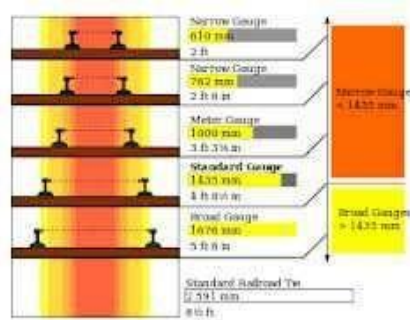

The different gauges used in India can be broadly classified as following four types.

1. Broad Gauge : Width 1676 mm to 1524 mm.
2. Standard Gauge : Width 1435 mm and 1451 mm.
3. Meter Gauge : Width 1067 mm, 1000 mm and 915 mm.
4. Narrow Gauge : Width 762 mm and 610 mm.

**Suitability of these gauges under different conditions**

1. Traffic condition - If the intensity of traffic on the track is likely to be more, a gauge wider than the standard gauge is suitable.
2. Development of poor areas - The narrow gauges are laid in certain parts of the world to develop a poor area and thus link the poor area with the outside developed world.
3. Cost of track -The cost of railway track is directly proportional to the width of gauge. Hence, if the funds available is not sufficient to construct a standard gauge, a meter gauge or a narrow gauge is preferred rather than to have no railways at all.
4. Speed of movement - The speed of a train is a function of the diameter of wheels which in turn is limited by the gauge. The wheel diameter is usually about 0.75 times the gauge width and thus, the speed of a train is almost proportional to the gauge. If higher speeds are to be attained, the B.G. track is preferred to the M.G. or N.G. track.
5. Nature of Country - In mountainous country, it is advisable to have a narrow gauge of track since it is more flexible and can be laid to a smaller radius on the curves. This is the reason why some important railways, covering thousands of kilometers, are laid with a gauge as narrow as 610 mm.

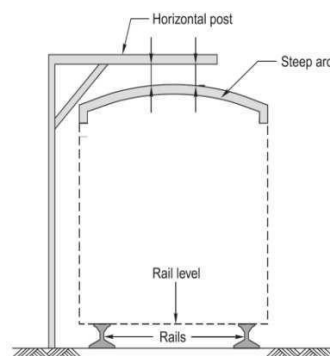
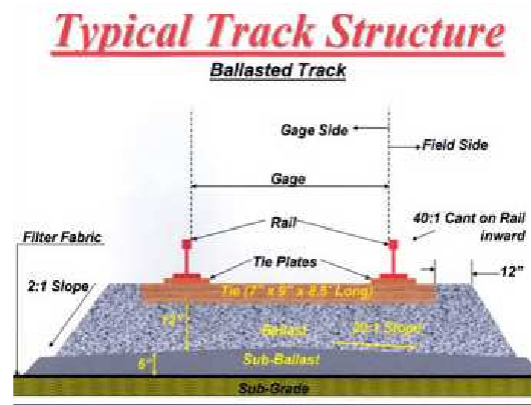

Fig. 2.2 Loading gauge

## CHAPTER-3

### TRACK MATERIALS



### RAILS

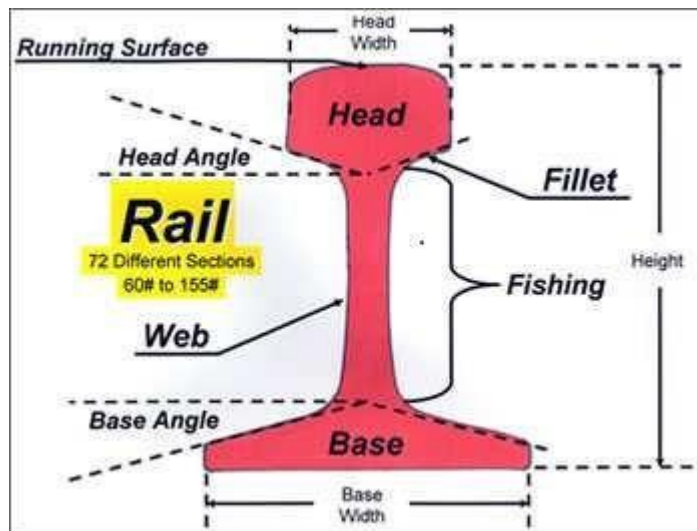

#### Function of Rails

- To transmit the moving loads to the sleepers
- To provide strong, hard and smooth surface for the train journey.
- To bear the stresses developed in the track due to temperature changes and loading patterns. To serve as lateral guide to the running wheels.
- To resist breaking forces caused due to stoppage of trains.



### **Requirements of an Ideal Rail**

1. The rail section consists of three components: head, web and foot. It should be designed for optimum nominal weight to provide for the most efficient distribution of metal in its various components.
2. The bottom of head and top of the foot should be given such shapes that fish-plates can easily be fitted.
3. The C.G. of the rail section should be located very near to the centre of height of rail so that maximum tensile and compressive stresses are more or less the same.
4. The depth of head of rail should be sufficient to allow for adequate margin of vertical wear.
5. The rail should possess adequate lateral and vertical stiff nesses.
6. There should be balanced distribution of metal in the head,web and foot of rail so that each of them is able to fulfill its assigned function.
7. The surface of rail table and gauge face of rail should be hard and should be capable of resisting wear.
8. The thickness of web of rail should be sufficient to take safely the load coming on the rail.

### **TYPES OF RAIL SECTIONS**

#### **Double headed rails:**

These were the rails which were used in the beginning, which were double headed and consisting of a dumb-bell section. The idea behind using these rails was that when the head was worn out in course of time, the rail can be inverted and reused. But as time passed indentations were formed in the lower table due to which smooth running over the surface at the top was impossible.

#### **Bull headed rails:**

In this type of rail the head was made a little thicker and stronger than the lower part by adding more metal to it, so that it can withstand the stresses.

#### **Flat footed rails:**

These rails are also called as vignole's rails. Initially the flat footed rails were fixed to the sleepers directly and no chairs and keys were required. Later on due to heavy train loads problems arose which lead to steel bearing plates between the sleeper and the rail. at rail joints and other important places these are the rails which are most commonly used in India.

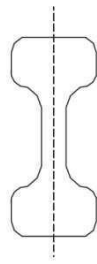

Double headed rail

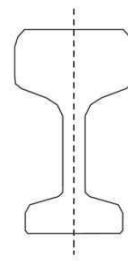

Bull headed rail

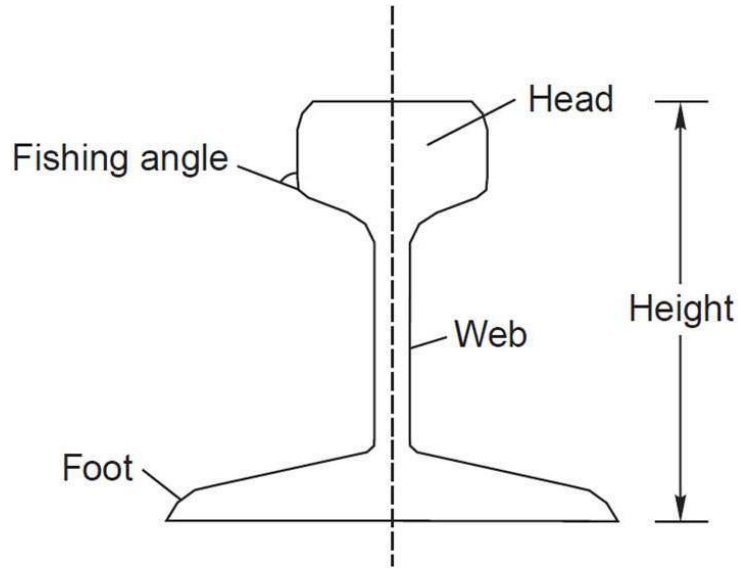

Flat-footed rail

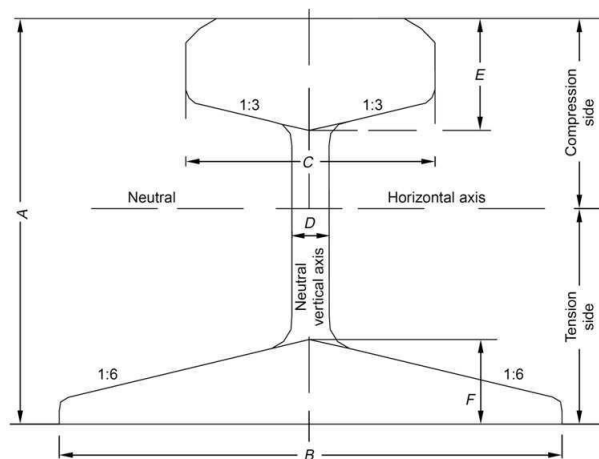

Standard flat-footed rail section

### Length of the Rails:

From the consideration of strength of the track maximum possible length is advisable as it will reduce the number of the joints, less number of fittings and fixtures and economical maintenance. But in practice the following factors are considered to decide the length of rails.

- i) Ease of transportation
- ii) Reasonable cost of manufacture
- iii) Ease in loading into the available wagons
- iv) Development of temperature stresses

Indian Railways have adopted the following length of rails in practice.

- i) For BG tracks = 13 m (42')
- ii) For MG & NG tracks = 12 m (39')

### **Rail Joints**

Rail joints are necessary to hold the adjoining ends of the rails in the correct position, both in the horizontal and vertical planes.

Types of Rail joints ☺ The following are the type of rail joints

#### **Supported rail joints:**

When the rail ends rest on a single sleeper it is termed as supported joint. The duplex joint sleeper with other sleepers is an example of the supported joint.

#### **Suspended rail joint:**

When rail ends are projected beyond sleepers it is termed as suspended joint. This type of joint is generally used with timber and steel through sleepers.

#### **Bridge joints:**

When the rail ends are projected beyond sleepers as in the case of suspended joint and they are connected by a flator corrugated plate called as bridge plate it is termed as a bridge joint.

#### **Insulated joint:**

When an insulating medium is inserted in a rail joint to stop the flow of current beyond the track circuited part then that type of joint is called an insulated joint.

#### **Compromise joint:**

Where two different rail sections are required to be joined together it is done by means of fish plated which fit both rails and this joint is termed as compromise joint.

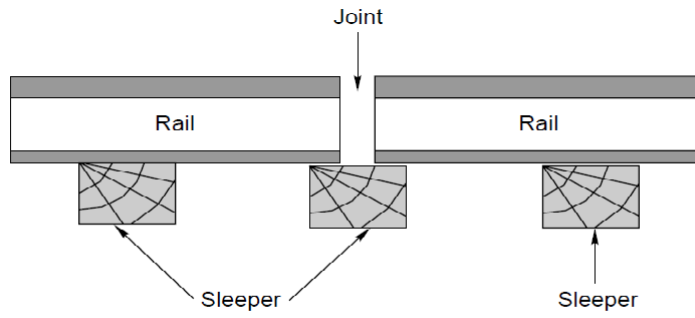

Supported rail joint

---

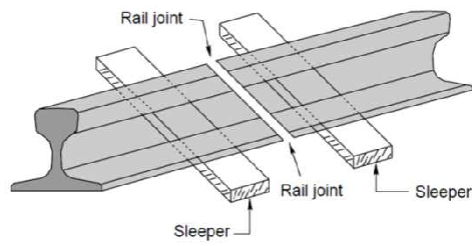

Suspended joint

---

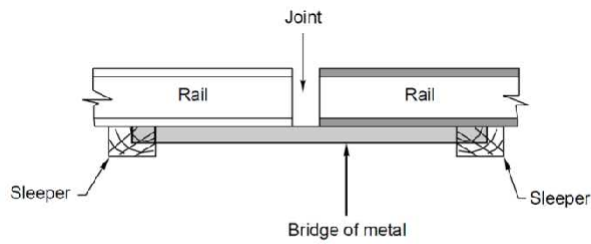

Bridge joint with metal flat

---

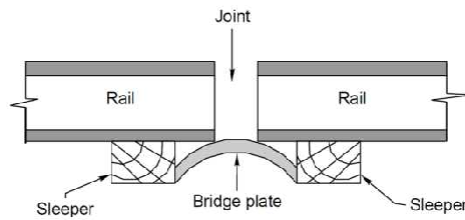

Bridge joint with bridge plate

---

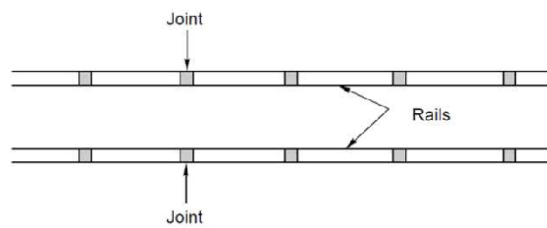

Square joint

---

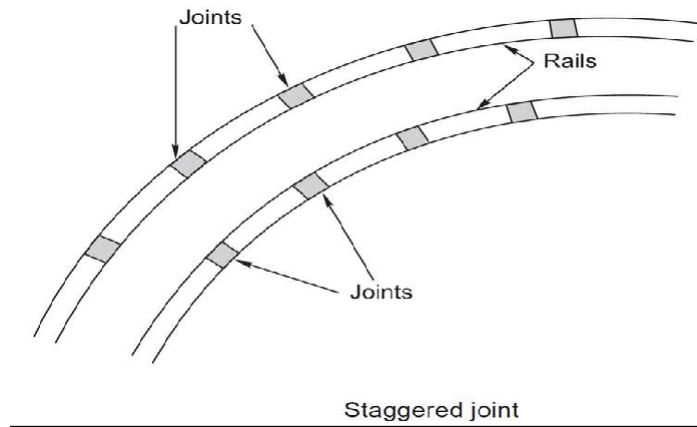

### **Requirements of an Ideal Rail Joint**

- i) Ends to remain true
- ii) Should be strong and stiff
- iii) Provision for expansion
- iv) Perfectly elastic
- v) Ends should not get battered
- vi) Provision for easy removal and replacement
- vii) Economical in cost

### **Purpose of Welding of Rails**



### **Welded rail joint**

#### **Purpose of welding:**

- To increase the length of the rails
- To repair the worn out or damaged rails
- To build up worn out points and rails on the sharp curves

#### **Advantages of welding rails:**

- Reduces the creep and friction due to increase in length of rail.
- Expansion effect due to reduction in temperature.

- Increase the life of the rails due to decrease in wear.
- It facilitates track circuiting on electrified tracks.
- The cost decrease because as the length increase automatically the number of joints decreases.
- High frequency vibrations due to heavy moving loads are decreased due to the heaviness of the rails.

**CREEP**



Creep in rails denotes longitudinal movement of rails in the track.

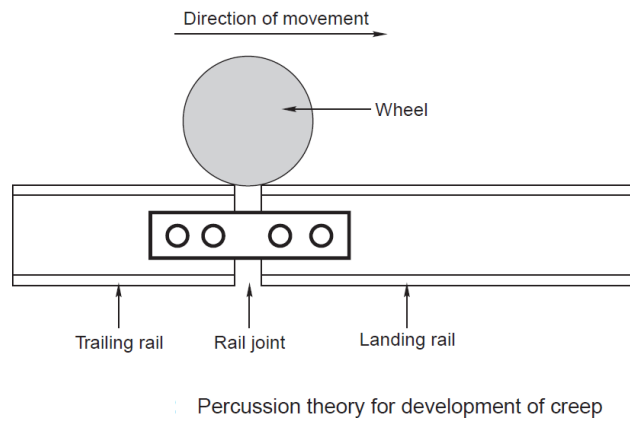
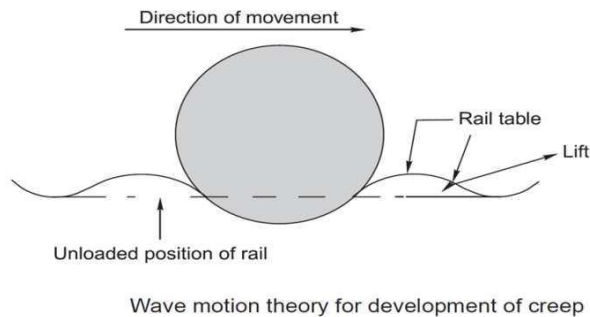

The following figure shows a type of Fair V-anchor which is used in the track to prevent creep of rails.

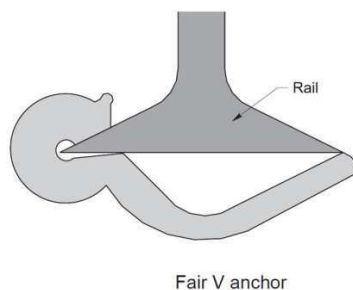

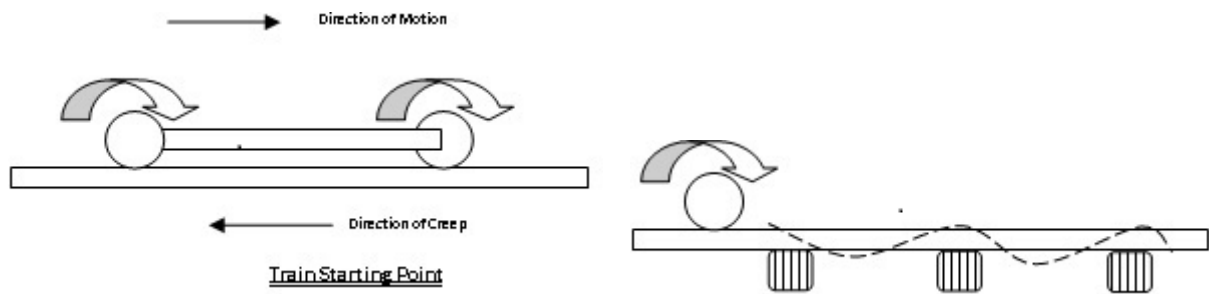

It is defined as the longitudinal movement of rails with respect to sleepers in a track.

### **Causes of creep:**

1. Closing of successive expansion spaces at rail joints in the direction of creep and opening out of joints at the point from where the creep starts.
2. Marks on flanges and webs of rails made by spike heads by scraping or scratching as the rails slide.

### **Effects of Creep:**

1. Sleepers move out of position which leads to the change in gauge and alignment of the track.
2. Rail joints are opened out of their limit in some case and stresses are set up in fish plates and bolts which leads to the breakage of the bolts.
3. Pints and crossings get disturbed.
4. Maintenance and replacement of tracks becomes difficult.
5. Smashing of fish plates and bolts, bending of bars, kinks at joints are other effects of creep.

## **Sleepers & Ballast**

### **Definition:**

Sleepers (known in the US as railroad ties) are used as a base for laying railway tracks. Sleepers were traditionally made from wood but are now usually made from concrete. Ties are laid on top of sand, gravel or heavy crushed stone - called ballast.

### **Functions of sleepers**

The functions of sleepers are as follows

1. To hold the rails in correct gauge i.e exact gauge in the case of straight and flat curves, loose gauge in the case of sharp curves and tight gauge in the case of diamond crossings.
2. To act as an elastic medium between the ballast and rail to absorb the blows and vibrations of moving loads.
3. They also add to the longitudinal and lateral stability of the permanent track on the whole.
4. They also provide means to rectify track geometry during service life.
5. To support the rails at proper level in straight tracks and at proper super elevation on curves.
6. To distribute the load from the rails to the index area of ballast underlying it or to the girders in the case of bridges.
7. To hold the rails in proper level.

### **Requirements of Good Sleepers**

1. It should be economical
2. It should be minimum possible initial and maintenance costs.
3. The fittings should be such that they can be easily adjusted.
4. Weight should not be too heavy or too light.
5. It should not be easily damaged by anti Nationals.
6. They should be capable of resisting shocks and vibrations.
7. The insulation of rails should be possible for track circuiting, if required through sleepers.
8. It should be designed that it could not be disturbed from its position easily by the passage of trains.

### **Classification of Sleepers**

Sleepers can be classified into the following types according to the material of construction.

#### **1. Wooden sleepers**

#### **2. Metal sleepers**

- Cast iron sleepers

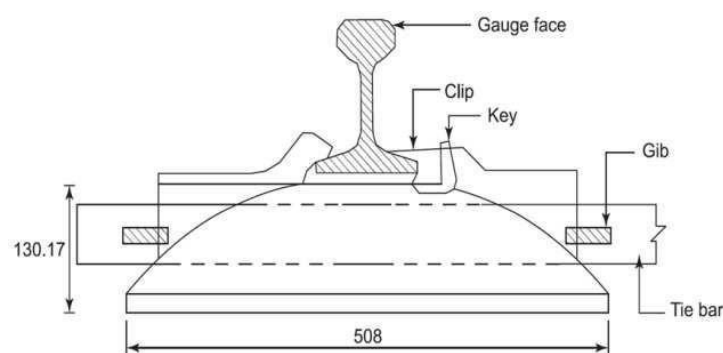

CI pot sleeper (dimensions in mm)



### 3. Steel sleepers

### 4. Concrete sleepers

- Reinforce concrete sleepers
- Prestressed concrete sleepers

### Timber or Wooden Sleepers

wooden sleepers are regarded as the best as they satisfy almost all the requirements of a good sleeper. The life of timber sleepers depend upon their ability to resist

- Wear and tear
- Decay
- Attack by white ants
- Quality of the timber used

#### **Advantages:**

- It is easily available in all parts of india
- Fittings are few and simple in design
- They are easy to lay, relay, pack, lift and maintain
- They are suitable for all types of ballast
- They are able to resist the shocks and vibrations of the heavy moving loads
- They are economical

#### **Disadvantages:**

- They are subjected to decay, attack by white ants, warping, cracking and end splitting
- It is difficult ot maintain the gauge in the case of wooden sleepers.
- It is difficult to maintain the alignment in the case of wooden sleepers.
- They have got minimum service life(12 to 15 yrs) as compared to other types of sleepers

## Concrete Sleepers

Concrete sleepers are made of a strong homogeneous material, impervious to effects of moisture and unaffected by the chemical attacks. It is moulded easily to size and shape required and it is an ideal material to withstand stresses introduced by fast and heavy traffic.

### **Advantages**

1. The concrete sleepers are quite heavy and thus provide longitudinal, lateral and vertical stability. Because of their weight, these sleepers are more suitable to LWR tracks.
2. The concrete sleepers result in reduced rail bending stresses.
3. The concrete sleepers reduce the wear of rolling stocks.
4. The concrete sleepers produce less vertical motion and thus provide a comfortable journey due to less noise.
5. The concrete sleepers have flat bottoms. That's why modern method of track maintenance i.e. MSP and machine maintenance can be suitably employed.
6. The concrete sleepers are neither flammable nor subjected to damage by corrosion or termite.
7. These sleepers have a long useful life of 50 years. It means rail and sleeper renewals can be matched.
8. The concrete sleepers with their fastening system maintain gauge, cross levels, twist, alignment, longitudinal level and unevenness of the track.
9. The concrete sleepers are suitable for track circuiting.
10. The concrete sleepers can be manufactured from local resources.

### **Disadvantages**

1. They are not economical because of high cost of construction.
2. In case of derailments, heavy damage is caused.
3. High standard of maintenance of track is required.
4. The design and construction are both complicated.
5. They are more rigid.
6. They do not have any scrap value.

## Steel sleepers

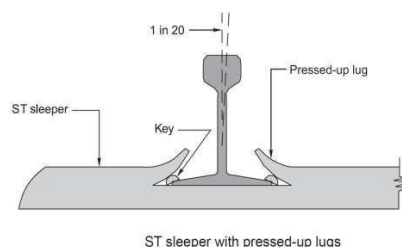

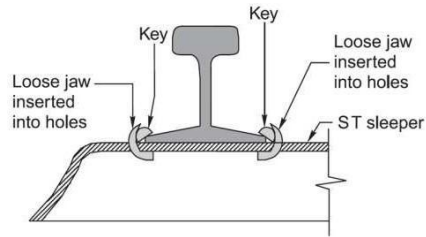

Sleeper with loose jaws inserted into holes

Steel sleepers are lightweight, dimensionally more accurate than wooden or concrete and regarded as an effective technical solution for modern rail networks.

### Advantages of steel Sleepers

1. They are manufactured by a simple operation.
2. They can be easily handled as these are light in weight as compared to other types of sleepers. Hence, damages during handling and transporting are less.
3. Less number of fastenings are required and that too simple in nature.
4. The maintenance and adjustment of gauge are easy as compared to the other of sleepers.
5. These sleepers are rolled sections in one piece.
6. Their life is longer than that of other types of sleepers.
7. They provide better lateral rigidity to the track.
8. They are not attacked by vermins.
9. They are not susceptible to fire hazards.
10. Their scrap value is good.

### Disadvantages of Steel of Sleepers

1. The steel sleepers possess the following disadvantages:
2. They get easily rusted and corroded.
3. They develop cracks at rail seats or near lugs.
4. Their lugs get broken easily.
5. The steel sleepers do not provide effective track circuiting.
6. The steel sleepers can only be for the type of rails for which these are manufactured.
7. These develop the tendency to become center bound because of slope at both ends.
8. The overall cost of steel sleepers is more than that of timber sleepers.

## Ballast

### Definition:

It is a layer of broken stones, gravel or any other such gritty material laid and packed below and around sleepers.

### Functions of ballast:

- To distribute the loads uniformly over the subgrade.
- To provide good drainage for the track structure.
- To provide elasticity and resilience to track for getting proper riding comfort.
- To held the track structure to line and grade.
- To reduce dust.
- To prevent growth of brush and weeds.

### Requirements of Good Ballast

1. It should be tough and should not crumble under heavy loads.
2. It should not make the track dusty or muddy.
3. It should offer resistance to abrasion and weathering.
4. It should not produce any chemical reaction with rails and sleepers.
5. The materials should be easily workable.
6. It should retain its position and should not be distributed.

### Materials used as Ballast

1. Broken Stone - Broken stone is one of the best materials for railway ballast to be used on the railway tracks. Almost all the important railway tracks are provided with broken stone. The stone to be used as railway ballast should be hard, tough nonporous and should not decompose when exposed to air and light. Igneous rocks like quartzite and granite forms the excellent ballast materials. When these are not available then lime stone and sand stone can also be used as good ballast material.

#### Advantages of Broken Stone

1. It holds the track in position
2. It is good for heavy traffic
3. It can serve high speeds

#### equally well. Disadvantages of Broken

#### Stone

1. The main disadvantage is that it is expensive in its initial cost.

2. Gravel - Gravel ranks next in its suitability for use as materials for ballast and is used in many countries of the world in very large quantities. Gravel consists of worn fragments of rocks occurring in



natural deposits. Gravel or shingle may be obtained from river bed or it may be dug out from gravel pits.

### Advantages of Gravel

1. It is cheaper in its cost as it has not to be broken as like stone ballast
2. It has got excellent drainage properties, if properly

### cleaned Disadvantages of Gravel

1. It easily rolls down under the vibrations and packing under the sleepers get tense
2. The variation in size is considerable and hence requires screening before use
3. Grovel as obtained from gravel pits, is full of earth and hence requires proper cleaning if proper drainage of the track is to be done.
3. Cinders Or Ashes- The residue from the coal in locomotives or other furnaces is called cinder or ashes. It is one of the universal forms of ballast as it is a byproduct of all the railway which uses coal as a fuel.

### Advantages of Cinders or Ashes

1. Handling of the material is not cumbersome this material can be handle easily
2. Cost is very low and hence can also be used for sidings
3. It has got fairly good drainage properties
4. Large quantities of this material can be made available at short notice.
5. In case of emergence such as caused by the destruction of portion of railway track during floods. This material proves to be very useful and is used in the formation repairing as well as for packing of track.

### Disadvantages of Cinders or Ashes

1. It is highly corrosive and cannot be used where steel sleepers are fixed
2. The foot of the rails get affected due to use of this type of material as ballast
3. It is very soft and can easily be reduced to powder under vibrations and hence the track becomes very dusty. This is objectionable particularly in dry weather.
4. Sand- Sand is another good materials for railway ballast , coarser sand is to be preferred to finer sand and the best sand is that which contains a quantity of fine gravel varying in size from 1/8 upwards.

### Advantages of Sand

1. If the sand is free from earth and vegetation then it has good excellent properties to drain off water immediately
2. It is cheaper if available in nearby locality
3. It produces very silent track and hence are suitable for packing cast iron pot sleepers.

### Disadvantages of Sand

1. It gets easily disturbed under vibrations and hence its maintenance is very difficult
2. The sand can be easily washed off or blown away and hence requires frequent renewal.
3. The sand particles may get into the moving parts of the vehicles and produces friction. This leads to heavy wear of vehicles.
5. Kankar- Kankar a lime agglomerate is found in many places in the form of nodules of varying sizes. Advantages of Kankar



1. Kankar is suitable Materials for ballast when other good material for ballast is not available or if available

uneconomically.

2. Kankar is good for light traffic on metre and narrow gauges  
Disadvantages of Kankar

1. It is very soft and can be reduced to powder form easily, hence, making the track dusty.
2. The maintenance of track is very difficult

6. Moorum-The decomposition of laterite results into the formation of moorum. It has red and sometimes yellow color. The best moorum is that which contains large quantities of small laterite stones.

Advantages of Moorum

1. Moorum is good materials for ballast when other material for ballast is not available.
2. Moorum can be safely used on newly laid track and acts as a soling when broken stones are laid afterwards.

3. Moorum has got good drainage properties  
Disadvantages of Moorum

1. Moorum is very soft and reduces to powder and hence to dust form in short time.
2. Maintenance of tracks laid with this material is difficult

7. Brick Ballast Or Brick Bats-Sometimes the broken pieces of over burnt bricks, called brickbats, are used as materials for ballast.

Advantages of Brick Ballast

1. It has got excellent drainage properties
2. They can be used as good ballast material where suitable material for ballast is either unavailable or uneconomical

Disadvantages of Brick Ballast

1. Brickbats turn down into powder form easily and hence the track becomes dusty
2. Maintenance of the track laid with this material as ballast is very difficult.
3. Rails are often corrugated on the tracks laid with this material as ballast

8. Selected Earth-Selected earth may be used as material for railway ballast for sidings and also for newly laid tracks.

### **Track fixtures for BG**

Rail joints – Fish plates – Fish bolts- Fang bolts- Hook bolts – Rail chairs and keys – Bearing plates – Blocks – Spikes-Elastic fastenings- Anchors & Anti creepers

### **Fastening**

A rail fastening system is a means of fixing rails to railroad ties. The terms rail anchors, tie plates, chairs and track fasteners are used to refer to parts or all of a rail fastening system. Various types of fastening have been used over the years.



## Fish Plates



In rail terminology, a fishplate, splice bar or joint bar is a metal bar that is bolted to the ends of two rails to join them together in a track. The name is derived from fish, a wooden bar with a curved profile used to strengthen a ship's mast. The top and bottom edges are tapered inwards so the device wedges itself between the top and bottom of the rail when it is bolted into place. In rail transport modelling, a fishplate is often a small copper or nickel silver plate that slips onto both rails to provide the functions of maintaining alignment and electrical continuity.

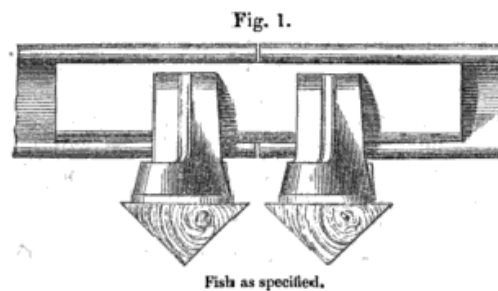

### **The first railway fishplate**

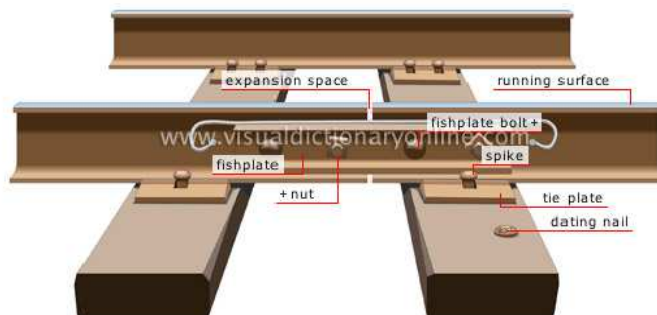

## RAIL-TO-RAIL Fastenings

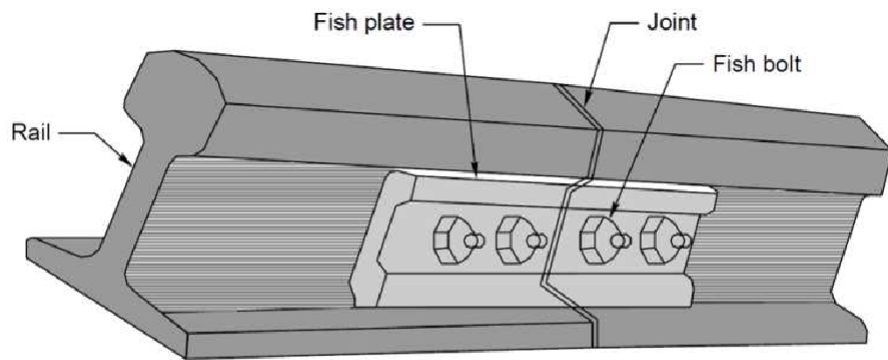

Fish plate

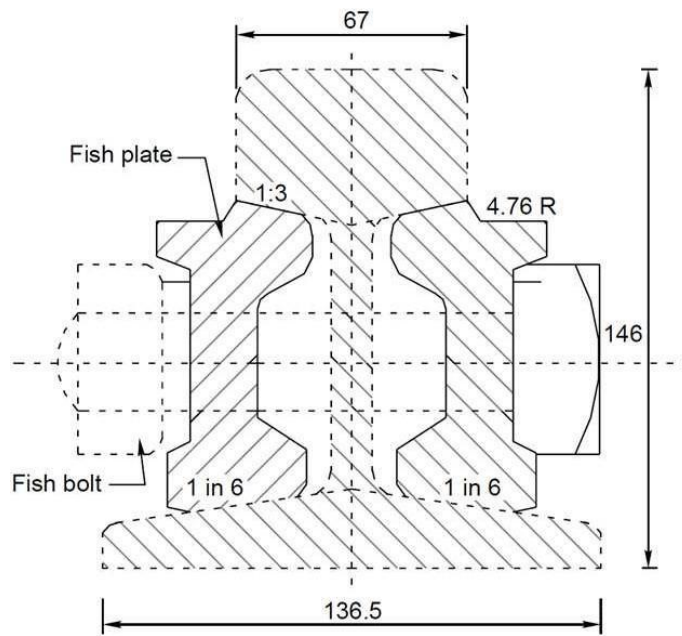

Fish plate for 90 R rails

**Combination Fish Plates**

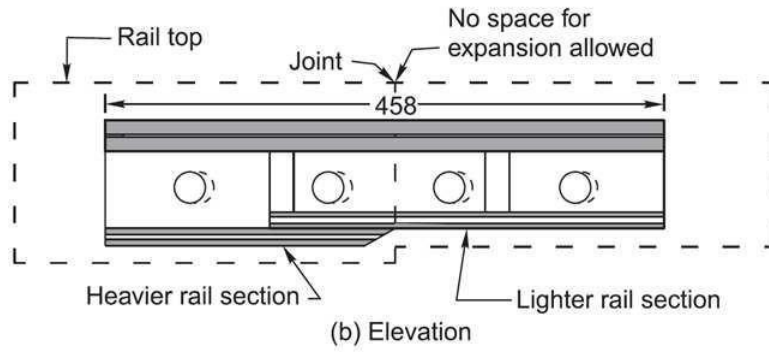
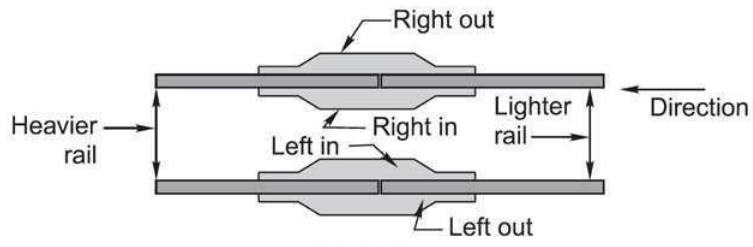

Combination fish plate (dimensions in mm)

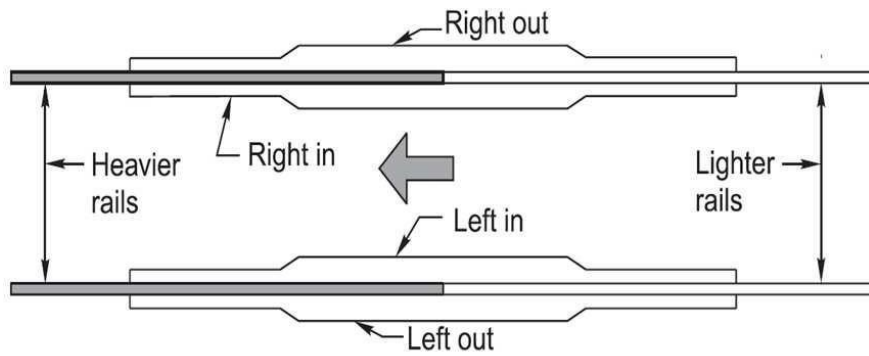

Marking of combination fish plates

**Fang Bolts**

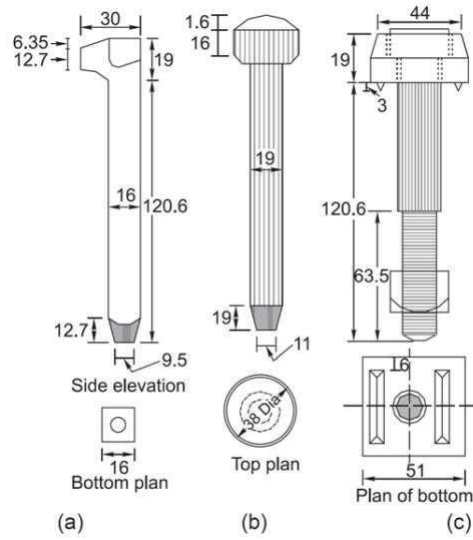

(a) Dog spike, (b) round spike, (c) fang bolt

### Screw Spikes

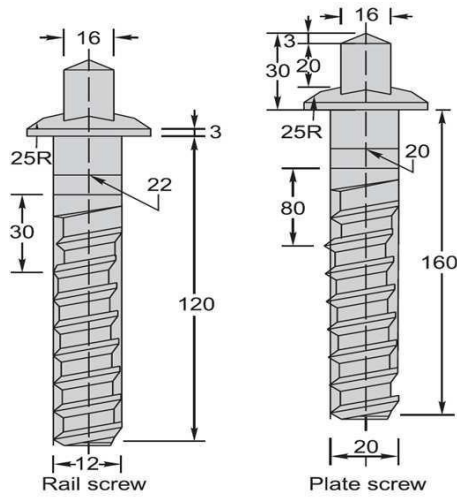

Screw spikes

### Bearing Plates

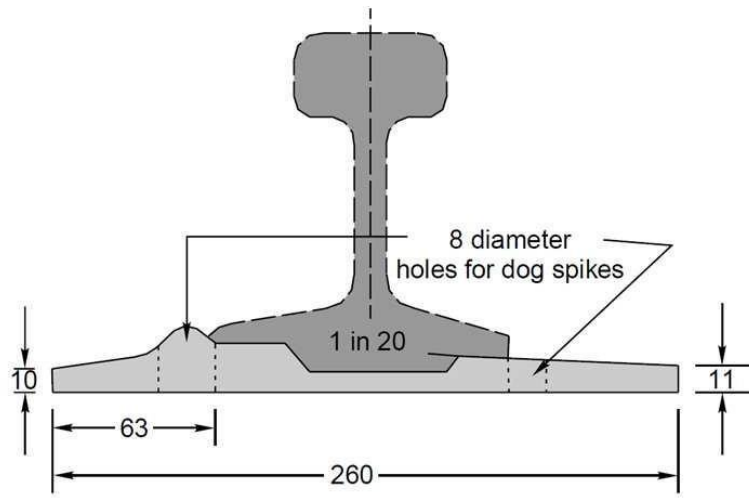

Canted MS bearing plate for 90 R (dimensions in mm)

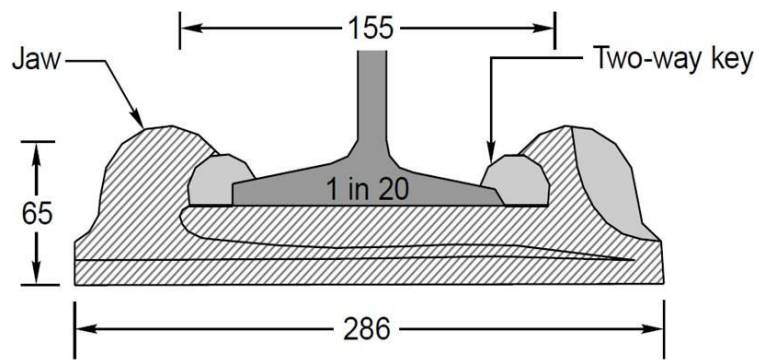

CI anticreep bearing plate

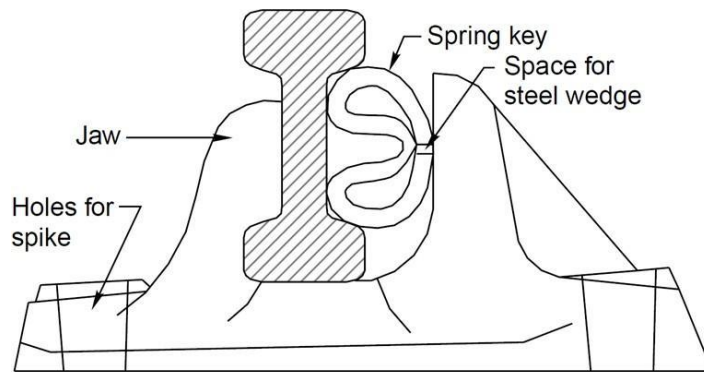

CI bearing plate for BH rail

**Fittings of Steel Trough Sleepers**

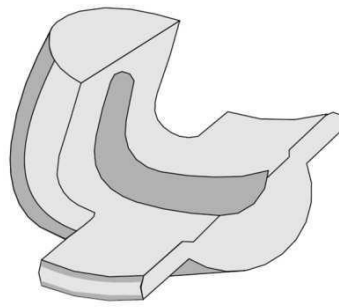

Spring steel loose jaw

**Rubber Coated & Epoxy-coated Fish Plates**

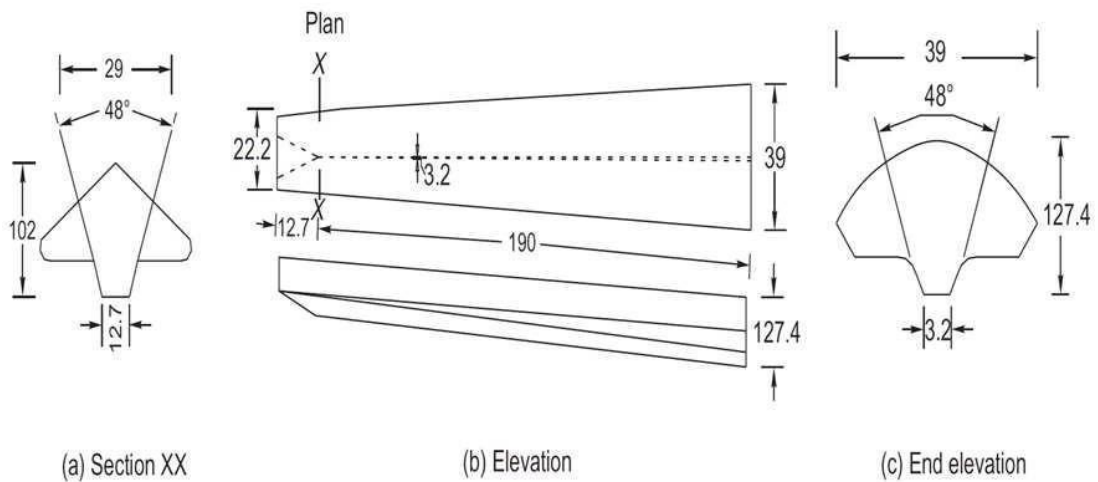

Two-way keys (dimensions in mm)

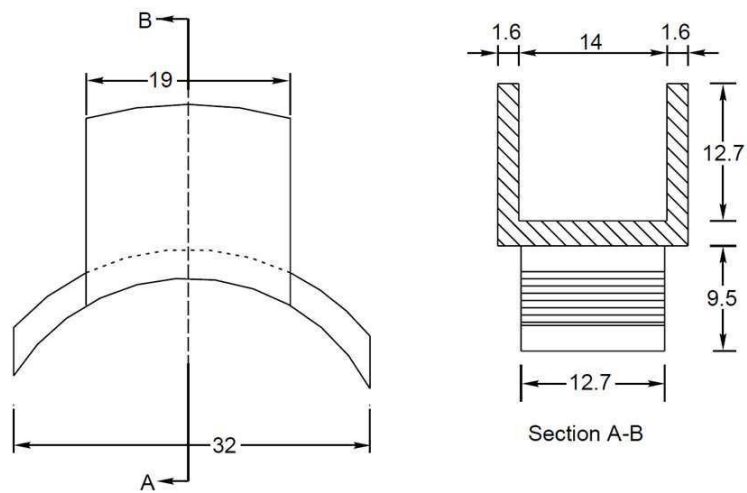

Mota Singh liner (all dimensions are in mm)

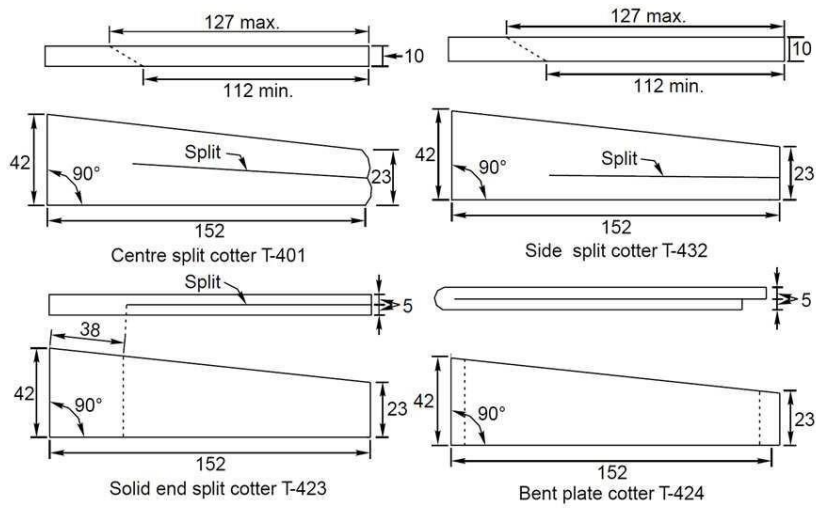

MS cotters (all dimensions are in mm)

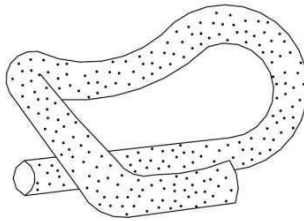

Pandrol clip or elastic rail clip

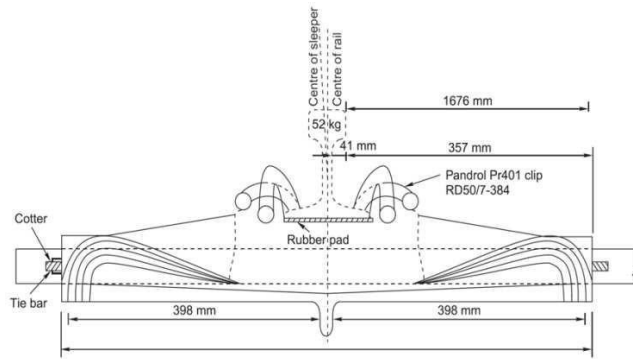

Isometric view of Pandrol clip

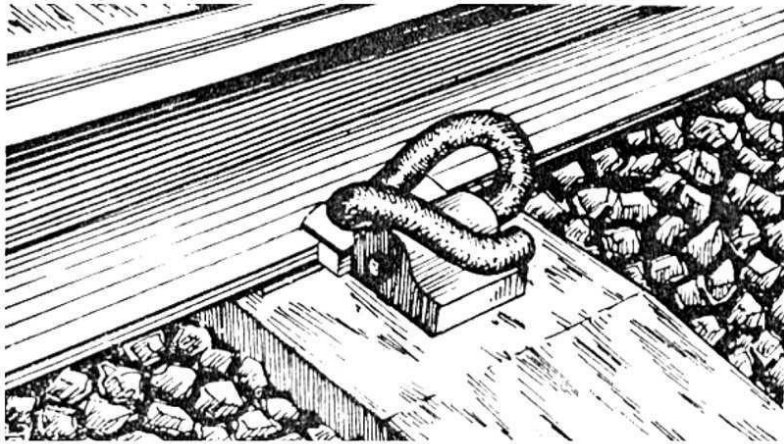

Pandrol clip fixed to the rail seat

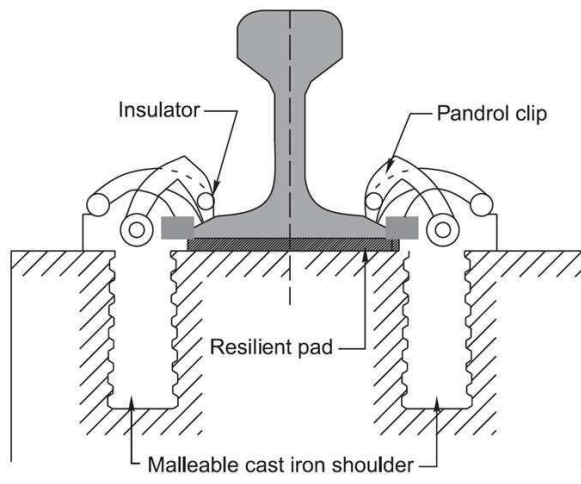

Insulated liners

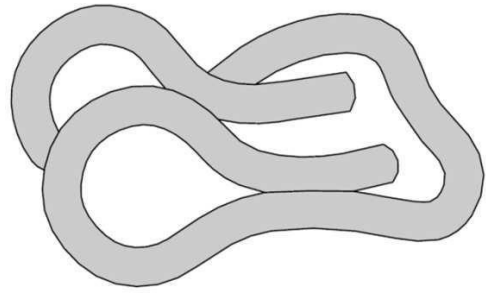

IRN 202 clip



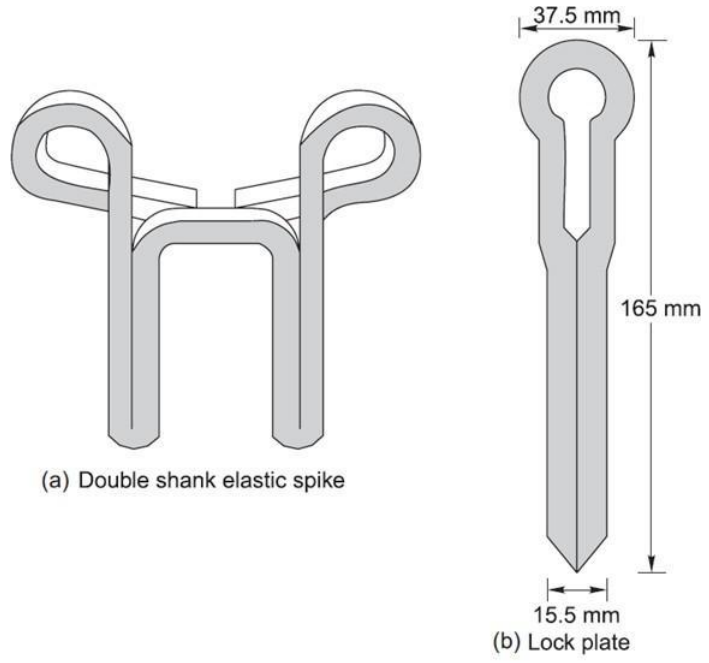

Lock spike

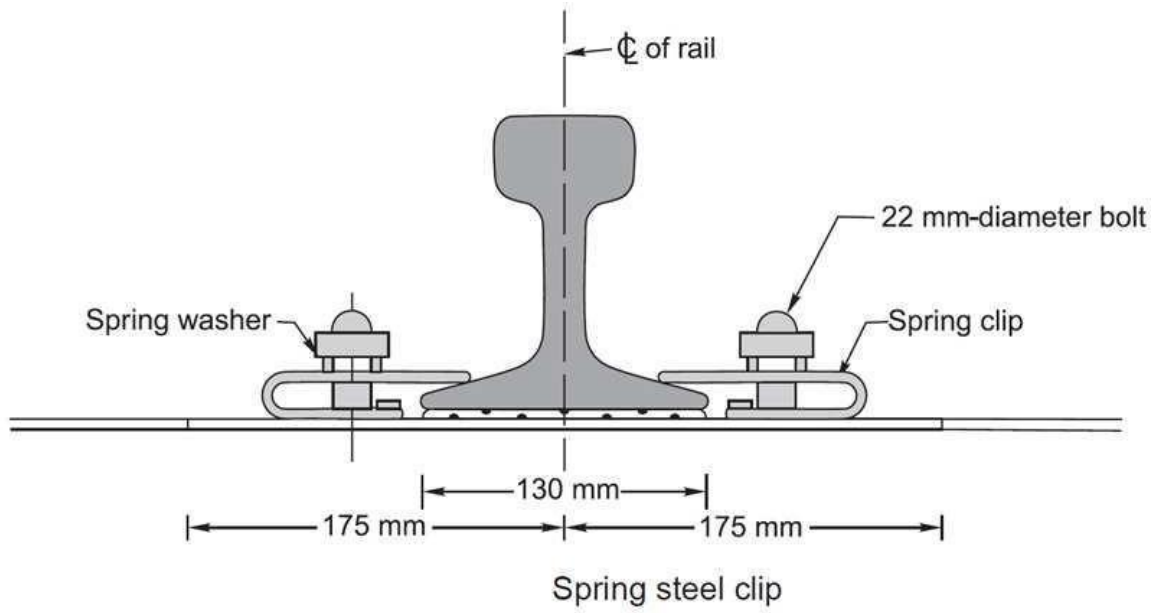

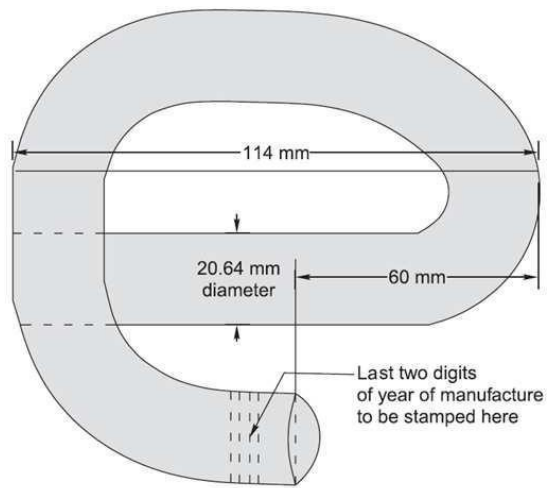

Pandrol clip (ERC rail clip) MK III

### New Elastic Fastening ( G Clip)

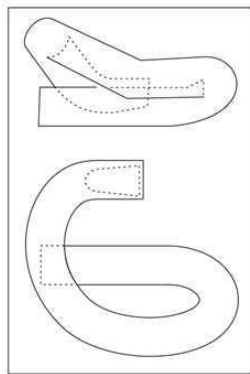

Logwell G clip

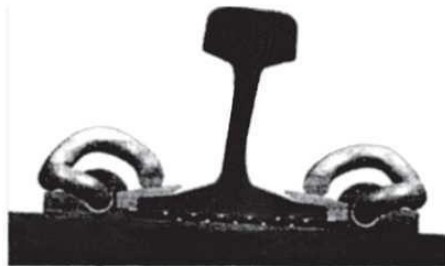

Isometric view of G clip assembly

**CHAPTER-4**

**Geometric for Broad gauge**

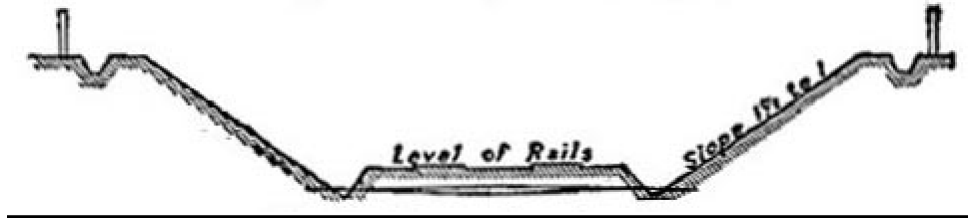

Typical Section of Railway in Cutting.

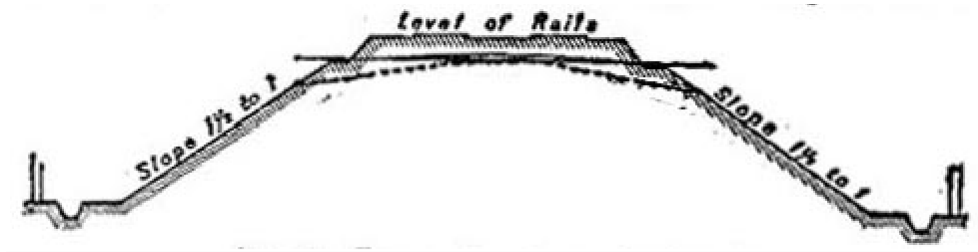

Typical Section of an embankment.

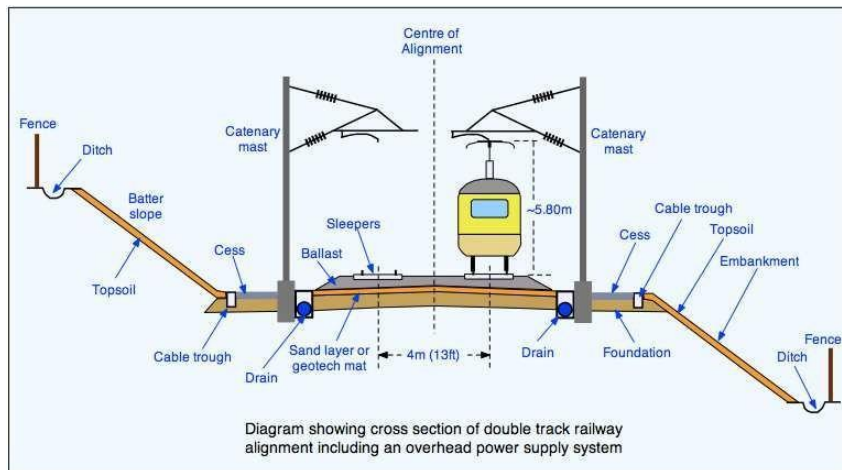

**Classification of Railway Land.** With a view to determine what the disposition of the land will probably be on the completion of the work for which it had been acquired, the classification given in paragraph 818 etc. should be adopted.

On railways, land is divided into two classes, viz.,

- (i) permanent land width

(ii) temporary land width

**Permanent land width** is land which will be required permanently after the railway is open for traffic and the work of construction is complete. Under this head will be included all land to be occupied by the formation of the permanent line of railway with side slopes of banks and cuttings, and the berms connected therewith; catchwater drains and borrow pits or such parts of them as it is necessary to retain; the entrances to tunnels and shafts belonging to them; the sites of bridges, and protection or training works; station yards; landing places for railway ferries; ground to be occupied by works belonging to the railway such as gas works, arrangements for water supply, septic tanks, collecting pits, filter beds and pumping installations, & c., ground for the storage manufacture or acquisition of materials; land for sanitary zones, cemeteries, churches, plantations; gardens, and recreation grounds, sites for stations, offices, workshops; dwelling houses and other buildings required for the purposes of the railway, or the accommodation of the staff, with the grounds, yards, roads, & c., appertaining thereto. Under this head will also be included land outside the permanent railway boundary, which will be required for the permanent diversion of roads or rivers, or for other works incidental to the construction of the railway, which are made for public purposes and will not on completion of the works be maintained by the railway authorities.

**Temporary land width** is land which is acquired for temporary purposes only, and which is disposed of after the work of construction is completed.

**Gradients for drainage**

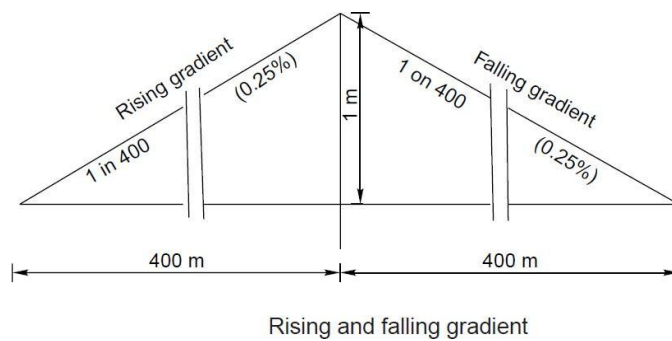

Drainage is defined as interception, collection and disposal of water away from track. Drainage is the most important factor in track maintenance and for stability of banks/cuttings. When water seeps into the formation, it weakens the bonds between the soil particles, softens the soil and results in creation of ballast pockets. On one hand, ingress of water into bank/cutting adds to weight of soil mass trying to slide, thereby increasing propensity for slope-slide, on the other hand, it reduces shear strength of soil, thereby decreasing factor of safety for stability of slope. Therefore, quick disposal of water from formation top/slopes is very essential. Drainage system should be effective in preventing the stagnation of water and allow quick disposal of water. At present, drainage is not being given its due importance in field. Provisions relating to drainage

have been detailed in various guidelines issued by RDSO from time to time, however, the present Guidelines highlight the salient features of drainage arrangement in embankment as well as cuttings.

## CONVENTIONAL DRAINAGE SYSTEMS

SURFACE DRAINAGE  
 SIDE DRAINS  
 CATCH WATER DRAINS  
 SUB SURFACE DRAINS

## SUPER ELEVATION

- (1) **Cant or super elevation** is the amount by which one rail is raised above the other rail. It is positive when the outer rail on a curved track is raised above inner rail and is negative when the inner rail on a curved track is raised above the outer rail.
- (2) **Equilibrium speed** is the speed at which the centrifugal force developed during the movement of the vehicle on a curved track is exactly balanced by the cant provided.
- (3) **Cant deficiency**- Cant deficiency occurs when a train travels around a curve at a speed higher than the equilibrium speed. It is the difference between the theoretical cant required for such higher speed and actual cant provided.
- (4) **Cant excess** - Cant excess occurs when a train travels around a curve at a speed lower than the equilibrium speed. It is the difference between the actual cant and the theoretical cant required for such a lower speed.
- (5) **Maximum permissible speed of the curve**-It is the highest speed which may be permitted on a curve taking into consideration the radius of the curvature, actual cant, cant deficiency, cant excess and the length of transition. When the maximum permissible speed on a curve is less than the maximum sectional speed of the section of a line, permanent speed restriction becomes necessary.
- (6) **Cant gradient** and cant deficiency gradient indicate the amount by which cant or deficiency of cant is increased or reduced in a given length of transition e.g., 1 in 1000 means that cant or deficiency of cant of 1 mm. is gained or lost in every 1000mm. of transition length.
- (7) **Rate of change of cant** or rate of change of cant deficiency is the rate at which cant or cant deficiency is increased or reduced per second, at the maximum permissible speed of the vehicle passing over the transition curve, e.g., 35 mm. per second means that a vehicle when traveling at a maximum speed permitted will experience a change in cant or deficiency of cant of 35mm. in each second of travel over the transition.
- (8) **Transition curve** is an easement curve, in which the change of radius is progressive throughout its length and is usually provided in a shape of a cubic parabola at each end of the circular curve. It affords a gradual increase of curvature from zero at the tangent point to the specified radius of circular arc and permits a gradual increase of super elevation, so that the full superelevation is attained simultaneously with the curvature of the circular arc.

## Superelevation, Cant deficiency and Cant excess

(1) Superelevation/cant

(a) The equilibrium superelevation/cant necessary for any speed is calculated from the formula

$$C = \frac{GV^2}{127R}$$

Where C is cant/superelevation in mm. G is the gauge of track width of rail head in mm. R is the radius of the curve in metres.

### Necessity of SuperElevation

In order to counteract the effect of centrifugal force the outside rail of the curve may be elevated above the inside rail effectively moving the centre of gravity of the rolling stock laterally toward the inside rail. This procedure is generally referred to as super elevation.

If the combination of lateral displacement of the centre of gravity provided by the super elevation, velocity of the rolling stock and radius of curve is such that resulting force becomes centered between and perpendicular to a line across the running rails the downward pressure on the outside and inside rails of the curve will be the same.

The super elevation that produces this condition for a given velocity and radius of curve is known as the balanced or equilibrium elevation.

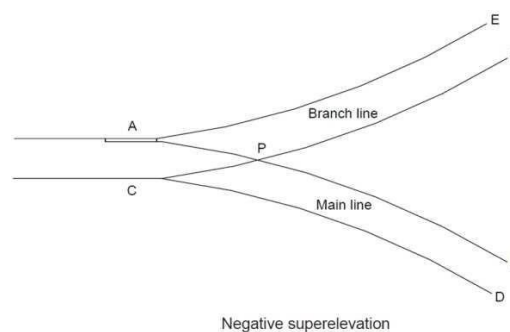
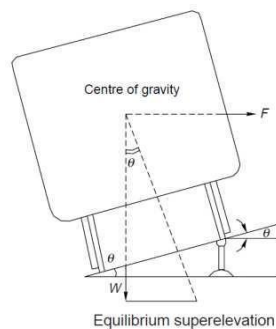

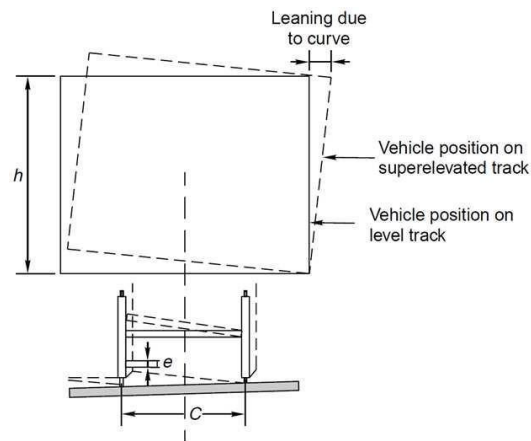

Effect of lean due to superelevation

### **Limitation of Super elevation**

#### **For Mixed Passenger & Freight Routes**

Typical early railway operation resulted in rolling stock being operated at less than equilibrium velocity (all wheels equally sharing the rolling stock weight), or coming to a complete stop on curves. Under such circumstances excess super elevation may lead to a downward force sufficient to damage the inside rail of the curve, or cause derailment of rolling stock toward the centre of the curve when draft force is applied to a train. Routine operation of loaded freight trains at low velocity on a curve super elevated to permit operation of higher velocity passenger trains will result in excess wear of the inside rail of the curve by the freight trains.

**Thus on these types of routes, super elevation is generally limited to not more than 6 inches.**

#### **For High Speed Passenger Routes**

Modern high speed passenger routes, do not carry slower speed trains, nor expect trains to stop on curves, so it is possible to operate these routes with higher track super elevation values. Curves on these types of route are also designed to be relatively gentle radius, and are typically in excess of 2000m (2km) or 7000m (7km) depending on the speed limit of the route.

**CHAPTER -5.0**

**POINTS AND CROSSING**

**Necessity:-**

- I. Points and crossing are provided to help transfer railway vehicle from one track to another.
- II. The track may be parallel to diverging from or converging with each other point and crossing are necessary because the wheels of railway vehicles are provided with inside flange and therefore they require this in special arrangement in order to navigate their way on the rail.
- III. The points or switches aid in diverting the vehicles and the crossing provide gaps in the rails so as to help the flanged wheels to roll over them.
- IV. A complete set of points and crossings, along with lead rails, is called a *turnout*.

**Points or Switches**

A pair of tongue rail and stock rail with necessary connection and fitting forms a switch

Crossing: - it is a device introduced at the junction where two rails cross each other to permit the wheel flanges of a railway vehicle to pass from one track to another

**Switches**

A pair of stock rail, AB and CD made of medium-manganese steel.

A pair of tongue rails, PCS and RS also known as switch rails made withstand wear. The tongue rails are machined to very thin section to obtain a snug fit with the stock rail is called ‘toe’ and thicker end is called the ‘heel’

A no. of slide chairs to support the tongue rail and enable from stock rail.

Two or more stretcher bars connecting both the tongue rails close to the toe for the purpose of holding them at a fixed distance from each other.

A gauge ties plate to fix gauges and ensure correct gauge at the points.

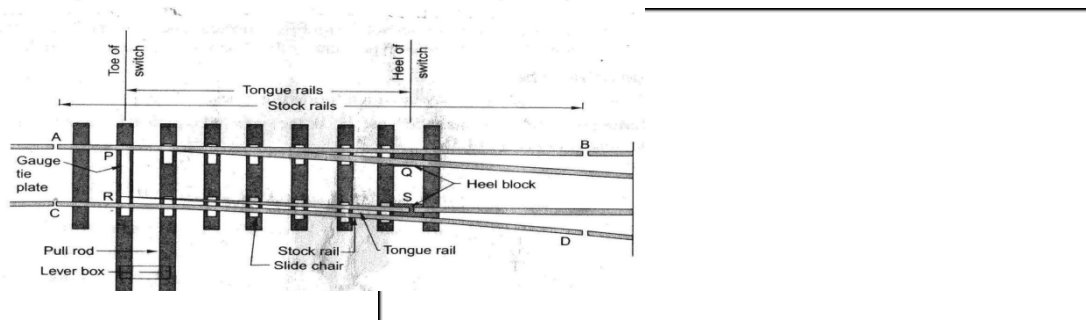

**FIGURE: DETAILS OF SWITCH**



## Types of Switches

Switches are of two types, namely 'stud switches' and 'split switch'.

In 'stud switch' no separate tongue rail is provided and some portion of the track is moved from one side to the other side.

In 'split switch' a pair of stock rail and pair of tongue rails are present, split switches are two types:-

### 1) Loose Heel type:-

In this type of split switch, the switch or tongue rail finishes at the heel of the switch to enable movement of the free end of the tongue rail.

The fish plates holding the tongue rail may be straight or highly bent.

The tongue rail is fastened to the stock rail with the help of a fishing fit block and four bolts.

All the fish bolts in the lead rail are tightened while those in the tongue rail are kept loose or snug to allow free movement of the tongue.

As the discontinuity of the track at the heel is a weakness in the structure, the use of these switches is structures, the use of these switches is not preferred.

### (2) Fixed Heel Type:-

In this type of split switch the tongue rail does not end at the heel of the switch, but extends further and is rigidly connected. The movement at the toe of the switch is made possible on account of flexibility of tongue rail.

### Crossing:-

A crossing or Frog is a device introduced at the point/junction where two gauge faces / rails cross each other to permit the wheel flanges of a railway vehicle to pass from one track to each other.

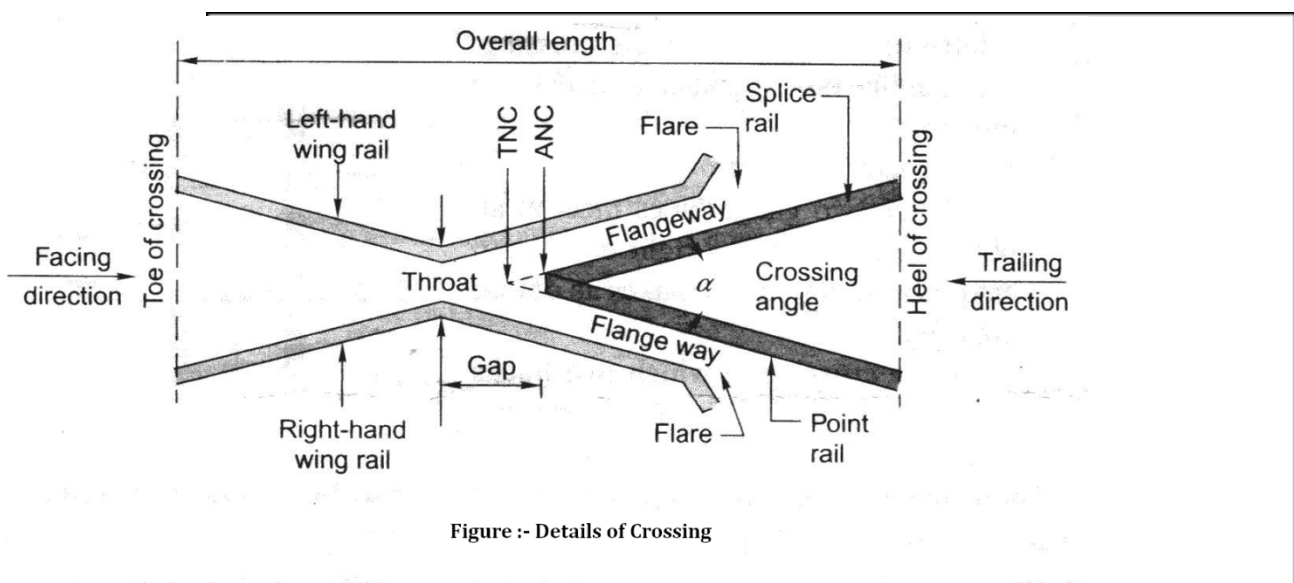

*A crossing consists of the following components.*

- (i) Two rails, *point rails and splice rails*, which are machined to form a nose. The point rail ends at the nose whereas the splice rail joins it a little behind the nose.

Theoretically, the point rail should end in a point and be made as thin as possible, but a knife edge of point rail would break off under the movement of traffic. The point rail therefore, has its fine end slightly cut off to form a blunt nose, with a thickness of 6mm. The toe of the blunt nose is called the *actual nose of crossing (ANC)* and the theoretical point where the gauge faces form both sides intersect is called the *theoretical nose of crossing (TNC)*. The 'V' rail is planed to a depth of 6mm (1/4") at the nose and runs out in 89mm to stop a wheel running in the facing direction from hitting the nose.

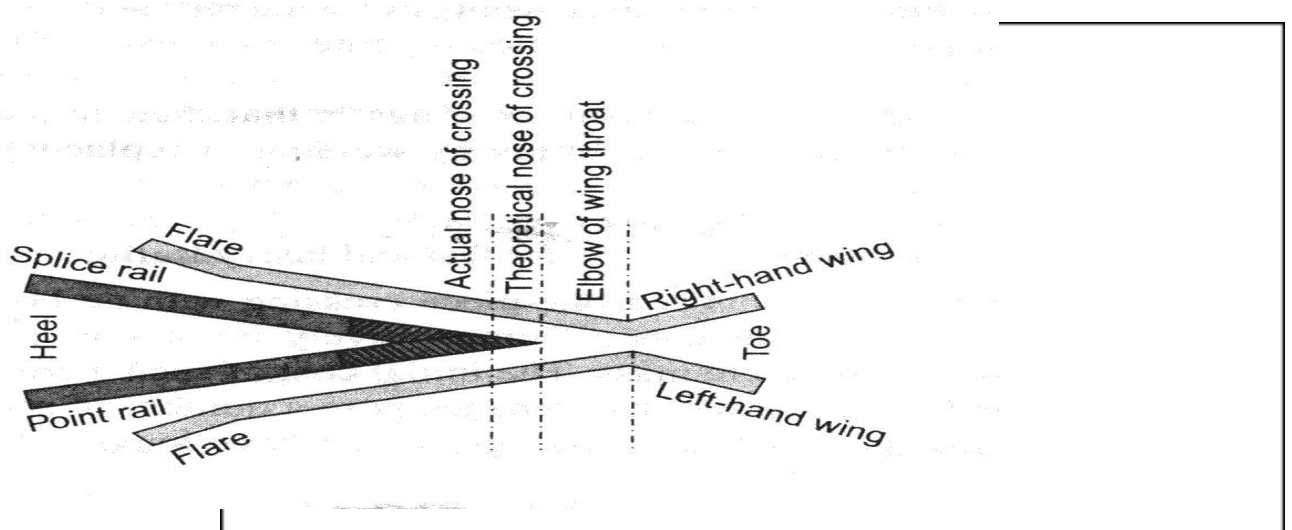

**Figure: - Point Rail and Splice Rail**

- (ii) Two wing rails consisting of a right hand and a left hand wing rail that converge to form a throat and diverge again on either side of the nose. Wing rails are flared at the ends to facilitate the entry and exit of the flanged wheel in the gap.
- (iii) A pair of check rails to guide the wheel flanges preventing them from moving sideways which would otherwise may result in the wheel hitting the nose of the crossing as it moves in the facing direction.

**TYPES OF CROSSING:**

**A crossing may be of the following types:-**

- (a) **An acute angle crossing or 'V' crossing** in which the intersection of two gauge faces forms an acute angle, For example when a right rail crosses a left rail, it makes an acute crossing. So unlike rail crossing from an acute crossing.

- (b) **An obtuse or diamond crossing** in which the two gauge faces meet at an obtuse angle. When a right on left rail crosses a similar rail, it makes an obtuse crossing.
- (c) **A square crossing** in which two tracks crossing at right angles, such crossings are rarely used in actual practice. For manufacturing purposes, crossing is of following types.

**According to manufacture, the crossing may be classified as mentioned under:-**

**(a) Built up crossing:-**

In a built-up crossing two wing rails and a V-section consisting of splice and point rails are assembled together by means of bolts and distance blocks to form a crossing.

Advantages:-

- (a) Initial cost is low.
- (b) Repair can be carried out by welding.

**(b) Cast steel crossing:-**

This is one piece crossing with no bolts and therefore requiring very little maintenance.

Comparatively

**Advantages:-**

- (a) Longer life.

**Disadvantages:-**

- (a) Initial cost is high.
- (b) Repair and maintenance causes a no of problem.

**(c) Combined rail and cast crossing:-**

is a combination of a built-up and cast steel crossing and consists of a cast steel nose finished to ordinary rail faces to form the two legs of the crossing.

Through it allows the welding of worn-out wing rails, the nose is still liable to fracture suddenly.

**CMS Crossing:-** Due to increase in traffic and the use of heavier axle loads, the ordinary built-up crossing manufacturer from medium –manganese rails subjected to vary heavy wear and tear, especially in fast lines and suburban sections with electric traction. Past experience has shown that life of such crossings varies six months to two years, depending on their location and service conditions. CMS crossings possess higher strength, offer more resistance to wear and consequently have a longer life.

**Advantages:-**

- Less wear and tear.
- Longer life.
- Free from bolts as wheel as other components that normally to get loose as a result of movement of traffic.

**Spring or Movable Crossing:-**

In a spring crossing, one wing rail is movable and held against the V of the crossing with a strong helical spring while the other wing rail is kept fixed. When a vehicle passes on the main track, the



movable wing rail is snug with crossing and the vehicle does not need to negotiate any gap at the crossing. In case the vehicle has to pass over a turnout track, the movable wing is forced out by the wheel flanges and the vehicle has to negotiate a gap as in normal turnout

This type of crossing is useful when there is high-speed traffic on the main track and slow-speed traffic on the turnout track

## CHAPTER 6

### METHODS OF LYING & MAINTENANCE OF TRACK:-

#### **Essential of Track Maintenance:-**

1. The gauge should be correct or within the specified limits.
2. There should be no difference in cross levels except on curves, where cross levels vary in order to provide superelevation.
3. Longitudinal levels should be uniform.
4. The alignment should be straight and kink-free.
5. The ballast should be adequate and sleepers should be well packed.
6. The track drainage should be good and formation should be well trained.

Railway track can be maintained either conventionally by manually labour or by the application of modern methods of track maintenance, such as mechanical tamping or measured shovel packing. The major maintenance operations performed in a calendar year (12-months) are as follows for achieving the above mentioned standards:-

- 1) **Through Packing:-**
- 2) **Systematic Overhauling**
- 3) **Picking up slacks**
  - 1) **Through Packing**

follows:-

Through Packing is carried out in a systematic and sequential manner as described as

#### **□ Opening of road:-**

The ballast is dug out on either side of the rail seat for a depth of 50mm (2") below the bottom of the sleeper with the help of a shovel with a wire claw. On the outside, the width of the opening should extend up to the end of the sleeper.

On the inside it should extend from the rail seat to a distance of 450mm (18") in case of BG, 350mm (14") in case of MG, and 250mm (10") in case of NG.

#### **□ Examination of rails, sleepers and fastening:-**

The rails, sleepers and fastening to be used are thoroughly examined. Defective sleepers are removed and loose fastening are tightened. Any kinks in rails are removed.

#### **□ Squaring of sleepers:-**

- (a) To do this one of the rails is taken as the sighting rail and the correct sleeper spacing is marked on it.
- (b) The position of the sleeper is checked with reference to the second rail with the help of a T-square.

- (c) The sleeper attended to after this defects have been established, which may include their being out of square or at incorrect spacing.

**□ Aligning the track:-**

- (a) The alignment of the track is normally checked visually, where in the rail is visually assessed from a distance of about four rail lengths or so.
- (b) Small errors in the alignment are corrected by slewing the track after loosening the cores at the ends and drawing out sufficient ballast at the ends of the sleeper.
- (c) Slewing is carried out by planting crowbar deep into the ballast at an angle not more than 30 from the vertical.

**Advantages of Track Maintenance:-**

1. If the track is suitably maintained, the life of the track as well as that of the rolling stock increases since there is lesser wear and tear of their components.
2. Regular track maintenance helps in reducing operating costs and fuel consumption.
3. Small maintenance jobs done at the appropriate time, such as tightening a bolt or key, hammering the dog spike, etc., help in avoiding loss of concerned fitting and thus saving on the associated expenditure.
4. When track maintenance is neglected for along time, it may render the track beyond repair, calling for heavy track renewals that entail huge expenses

**Gauging:-**

The gauge should be checked and an attempt should be made to provide a uniform gauge within permissible tolerance limits.

**2. Systematic overhauling:-**

The systematic overhauling of the track should normally commence after the completion of one cycle of through packing. It involves the following operations in sequence:-

- (a) Shallow screening and making up of ballast section.
- (b) Replacing damaged or brother fittings.
- (c) Including all items in through packing.
- (d) Making up the cess.

**3. Picking up stacks:-**

Stacks are those points in the track where the running of trains is faculty. Slacks generally occur in the following cases:-

- (a) Stretches of yielding formation.
- (b) Improperly aligned curves.
- (c) Portions of track with poor drainage.
- (d) Approaches to level crossing, girder bridges etc.
- (e) Section with an inadequate or unclean ballast cushion.

No through packing is done during the raining season and slacks are only picked up in order to



keep the track safe and in good running condition.

### **Duties of a permanent way Inspector (PWI)**

The PWI is generally responsible for the following:-

- (a) Maintenance and inspection of the track to ensure satisfactory and safe performance.
- (b) Efficient execution of all works incidental to track maintenance, including track relaying work.
- (c) Accounts and periodical verification of the stores and tools in his or her charge.
- (d) Maintenance of land boundaries between stations and at important stations as may be specified by the administration.

The PWI also carries out inspection of the following facts of a track.

- (a) Testing the track.
- (b) Inspection of track and gauge.
- (c) Level crossing inspection.
- (d) Point and crossing inspection.
- (e) Curve inspection.
- (f) Safety of track.

In addition to the inspections, a PWI also carries out following duties:-

- (a) Check the proximity of trees that are likely to damage the track and get them removed.
- (b) Check night patrolling at last once a month by train as well as by trolley.
- (c) Takes the necessary safety measures while executing maintenance work that affects the safety of the track.
- (d) Periodically inspects and respective LWR tracks to ensure their safety.
- (e) Ensures the cleanliness of station yards.
- (f) Keeps proper records of the training out of ballast.
- (g) Looks after all establishment work, including the welfare of the staff working under his charge and maintenance their service records.
- (h) Ensures the safety of the track during the execution of work that affects the track.



## SECTION-B

### CHA PTE R-7 BRI DG E EN GI NE RR IN G

#### DEFINATION

The following definitions of certain important terms used in Bridge Engineering are given below:

1. **Bridge:** - A structure is facilitating a communication route for carrying road traffic or other moving loads over a depression or obstruction such as river, stream, channel, road or railway. The communication route may be a railway track, a tramway, a roadway, footpath, a cycle track or a combination of them.
2. **High Level Bridge or Non-submersible Bridge:** - The Bridge which does not allow the high flood waters to pass over them. All the flood water is allowed to pass through its vents. In other words it carries the roadway above the highest flood level of the channel.
3. **Submersible Bridge:** - A submersible bridge is a structure which allows flood water to pass over bridge submerging the communication route. Its formation level should be so fixed as not to cause interruption to traffic during floods for more than three days at a time nor for more than six times in a year.
4. **Causeway:** - It is a pucca submersible bridge which allows floods to pass over it. It is provided on less important routes in order to reduce the construction cost of cross drainage structures. It may have vents for low water flow.
5. **Foot Bridge:** - The foot bridge is a bridge exclusively used for carrying pedestrians. Cycles and animals.
6. **Culvert:** - When a small stream crosses a road with linear waterway less than about 6 meters. The cross drainage structure so provided is called culvert.
7. **Desk Bridge:** - These are the bridge whose floorings are supported at top of the superstructures.
8. **Through Bridge.** These are the bridges whose floorings are supported or suspended at the bottom of the superstructures.
9. **Semi-Through Bridges:** - These are the bridges whose floorings are supported at some intermediate level of the superstructure.
10. **Simple Bridges:** - They include all beam, girder or truss bridges whose flooring is supported at some intermediate level of superstructure.



11. **Cantilever Bridges:** - Bridges which are more or less fixed at one end and free at other. It can be used for spans varying from 8 meters to 20 meters.
12. **Continues Bridges:** - Bridges which continue over two or more spans. They are used for large spans and where unyielding foundations are available.

13. **Arch Bridge:** - These are the bridges which [produce inclined pressures on supports under vertical loads. These bridges can be economically used up to spans about 20 meters. The arches may be in the barrel form or in the form of ribs.
14. **Rigid Frame Bridges:** - In these bridges the horizontal deck slab is made monolithic with the vertical abutments walls. These bridges can be used up to span about 20 meters. Generally this type of bridge is not found economical for spans less than 10 meters.
15. **Square Bridge:** - These are the bridges at right angles to axis of the river.
16. **Square Bridge:** - These are the bridges not at right angles to axis of the river.
17. **Suspension Bridges:** - These are the bridges which are suspended on cables anchored at ends.
18. **Under-Bridges:** - It is a bridge constructed to enable a road to pass under another work or obstruction.
19. **Over-Bridges:** - It is a bridge constructed to enable one from of land communication over the other.
20. **Class AA Bridges:** - These are bridges designed for I.R.C. class AA loading and checked for class A loading. They are provided within certain municipal limits, in certain existing or contemplated industrial area, in other specified areas, and along certain specified highways.
21. **Class A Bridges:** - These are permanent bridges designed for I.R.C. class A loading.
22. **Class B Bridges:** - These are permanent bridges designed for I.R.C. class B loading.
23. **Viaduct:** - It is a long continuous structure which carries a road or railways like Bridge over a dry valley composed of series of span over trestle bents instead of solid piers.
24. **Apron:** - It is a layer of concrete, masonry stone etc. placed like flooring at the entrance or out of a culvert to prevent scour.
25. **Piers:** - They are the intermediate supports of a bridge superstructure and may be solid or open type.
26. **Abutments:** - They are the end supports of the superstructure.
27. **Curtain Wall:** - It is a thin wall used as a protection against scouring action a stream.
28. **Effective Span:** - The centre to centre distance between any two adjacent supports is called as the effective span of a bridge.
29. **Clear Span:** - The clear distance between any two adjacent supports of a bridge is called clear Span.
30. **Economic Span:** - the span, for which the total cost of bridge structure is minimum is known as economic span.
31. **Afflux:** - due to construction of the Bridge there is a contraction in waterway. This results in rise of water level above its normal level while passing under the Bridge. This rise is known as afflux.
32. **Free Board:** - Free Board at any point is the difference between the highest flood level after allowing for afflux, if any, and the information level of road embankment on the approaches or top level of guide bunds at the points.
33. **Headroom:** - Headroom is the vertical distance between the highest points of a vehicle or vessel and the lowest points of any points of any protruding member of a Bridge.
34. **Length of the Bridge:** - The length of a Bridge structure will be taken as the overall length measure along the centre line of the Bridge from the end to end of the Bridge deck.

35. **Liner Waterway:** - The liner waterway of a Bridge shall be the length available in the bridge between extreme edges of water surface at the highest flood level, measures at right angles to the abutment faces.
36. **Low Water Level (L.W.L.):** - The low water level is the of water surface obtained generally in the dry season.
37. **Ordinary Flood Level (O.F.L.):**- It is average level of a high flood which is expected to occur normally every year.
38. **Highest Flood Level (H.F.L.):**- It is the level of highest flood every recorded or the calculated level for the highest possible flood.
39. **Effective Liner Waterway:** - Effective linear waterway is the total width of waterway of a bridge minus the effective width of obstruction. For calculating the effective linear waterways, the width of mean obstruction due to each pier shall be taken as mean submerged width of the pier at its foundation up to maximum scour level. The obstruction at ends due to abutments or pitched slopes should be ignored.

### **COMPONENTS OF A BRIDGE**

#### **The bridge structure is divided mainly into two components:**

##### **1) Substructure**

The function of substructure is similar to that of foundations, columns and walls etc. of a building.

Thus the substructure supports the superstructure and distributes the load into the soil below through foundation.

The substructure consists of foundation piers and abutment piers, foundation for the piers, abutments, wing walls, and approaches.

The above all supports the superstructure of the bridge.

##### **2) Superstructure**

The superstructure of a bridge is analogues to a single story building roof and substructure to that of walls, columns and foundations supporting it.

Superstructure consists of structural members carrying a communication route

It consists of handrails, parapets, roadways, girders, arches, wall trusses over which the road is support.

It is that part of the bridge over which the traffic moves safely

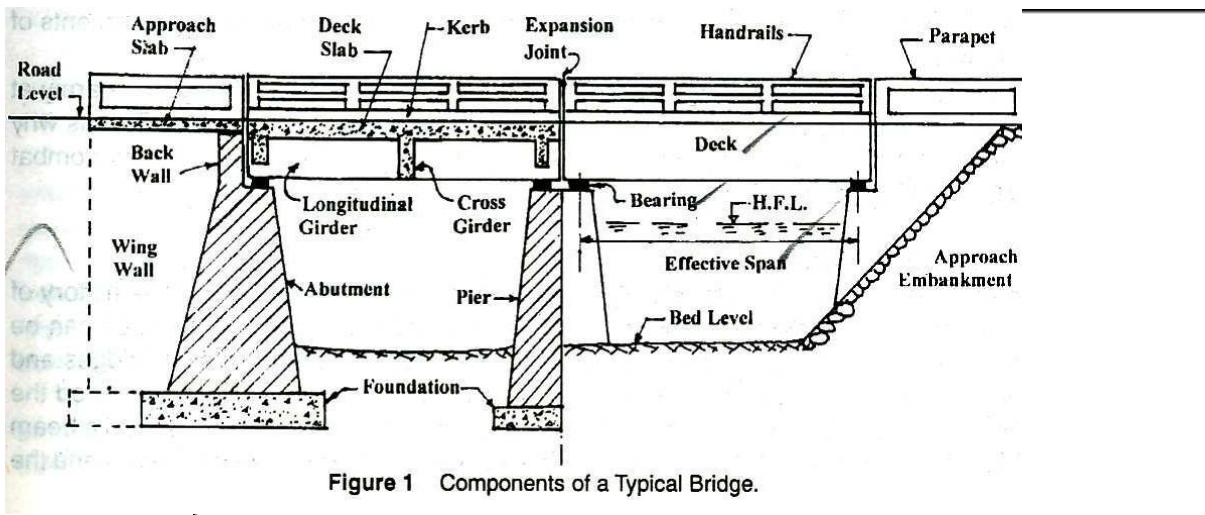

### Classification of a Bridge: -

The bridges may be classified depending upon the following factors:-

- (a) Their functions or purpose as railway, highway Foot Bridge, aqueduct etc.
- (b) Their material of construction used as timber masonry, R.C.C. Steel, prestresses concrete etc.
- (c) Nature or life span such as temporary permanent bridge etc.
- (d) Their relative position of floor such as deep bridge, through bridges etc.
- (e) Type of super-structure such as arched girder, truss, suspension bridge etc.
- (f) Loadings: - Road Bridges and culverts have been classified by I.R.C. into class AA, Class A, Class B bridges according to the loadings they are designed to carry.
- (g) Span Length:- Under this category the bridges can be classified as
  - Culverts (Span Less than 8m) i.e. BOX Type, Hume Pipe Type,
  - Minor Bridge ( Span length = 8 to 30m) i.e. BOX type, Girder Type
  - Major Bridge (Span Length =above than 30m)
- (h) Degree of Redundancy: - Under this the bridges can be classified as indeterminate bridges
- (i) Types of Connection:- Under this category the steel bridges can be classified as pinned connected , riveted or welded bridges.

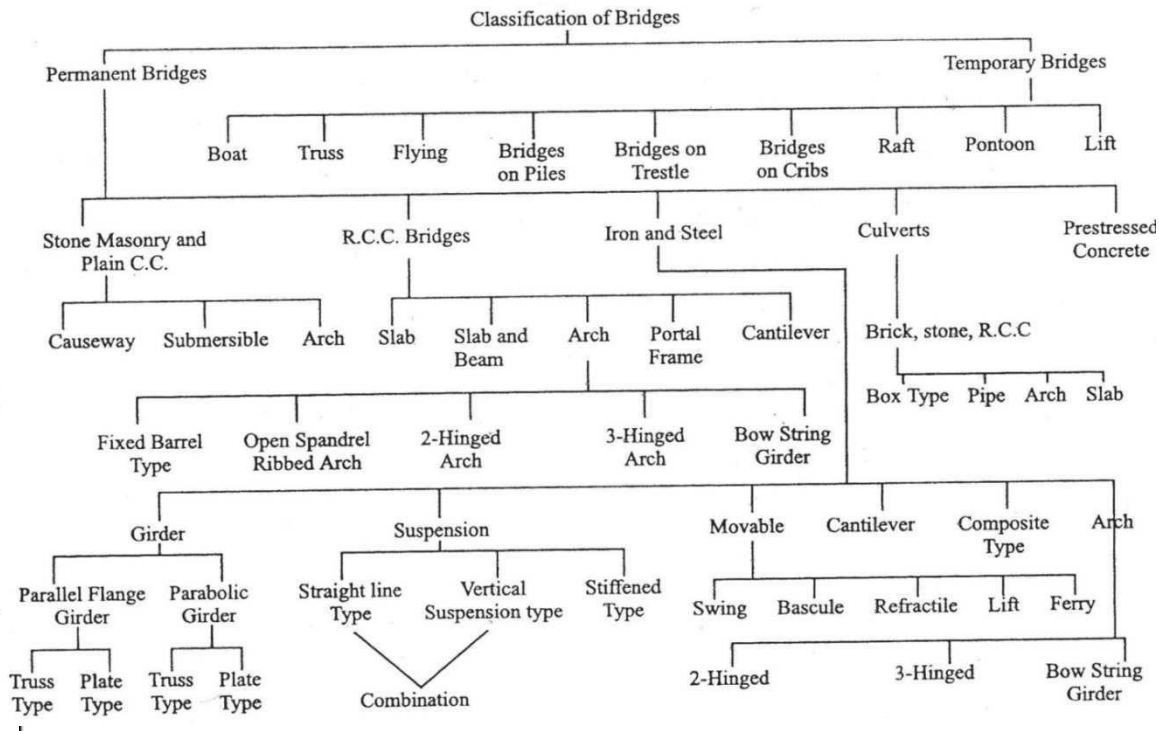

Classification of Bridge

### REQUIRMENTS OF AN IDEAL BRIDGE:-

An ideal bridge meets the following requirements to fulfil the three criteria of efficiency, effectiveness and equity

It serves the intended function with utmost safety and convenience

It is aesthetically sound

It si economical

The site characteristic of an Ideal Bridge has been discussed below:

1. The stream at the bridge side should be well defined and as narrow as possible.
2. There should be a straight reach of stream at bridge site
3. The site should have firm, permanent, straight and high banks.
4. Te flow of water in the stream at the bridge site should be in steady regime condition. It should be free from whirls and cross-current
5. There should be no confluence of large tributaries in the vicinity of bridge site
6. It should be reliable to have straight approach roads and square alignment, i.e. right-angled crossing
7. There should be minimum obstruction of a natural waterway so as to have minimum afflux
8. In order to achieve economy there should be easy availability of labour, construction material and transport facility in the vicinity of bridge site.
9. In order to have minimum foundation cost, the bridge site should be such that no excessive work is to be carried inside the water
10. At bridge site it should be possible to provide secure and economical approaches.

11. In case of curved alignment the bridge should not be on the curve, but preferably on the tangent since otherwise there is a greater likelihood of accident as well as an added centrifugal force which increases the load effect on the structure and will require modification of design.
12. There should be no adverse environmental impact
13. The bridge site should be such that adequate vertical height and waterway is available
14. Underneath the bridge for navigational use.

In actual practice the determination of best possible site for any proposed bridge is truly an economic problem. The various factors which should be carefully examined before settling finally upon the layout of a bridge as follows:

- i. Grade on alignment,
- ii. Geographical Conditions,
- iii. Government requirements,
- iv. Commercial influences ,
- v. Adjacent property consideration,
- vi. General features of the bridge structure,
- vii. Future trends for enlargement,
- viii. Time Consideration,
- ix. Foundation Considerations,
- x. Construction facilities available,
- xi. Erection Consideration,
- xii. Aesthetics,
- xiii. Maintenance and repairs,
- xiv. Environment Impact

## CHAPTER-8

### **Bridge Alignment:-**

Depending upon the angle which the bridge makes with the axis of the river, the alignment can be of two types:

- a) Square Alignments: - In this the bridge is at right angle to the axis of the river.
- b) Skew Alignments: - In this the bridge is at some angle to the axis of the river which is not a right angle.

Note: - As far as possible, it is always desirable to provide the square alignment. The skew alignment suffers from the following disadvantages:-

- (i) A great skill is required for the construction of skew Bridges. Maintenance of such type of Bridges is also difficult.
- (ii) The water-pressure on piers in case of skew alignment is also excessive because of non-uniform flow of water underneath the bridge superstructure.
- (iii) The foundation of skew bridge is more susceptible to scour action.

### **Flood Discharge: -**

One of the essential data for the bridge design is fair assessment of the maximum flow which could be expected to occur at the bridge site during the design period of the bridge. The conventional practice in India for determination of flood discharge is to use a few convenient formulae or past records.

Note: - This faulty determination of flood discharge which led to failure of many hydraulic structures.

As per I.R.C. recommendation the maximum discharge which a bridge on a natural stream should be designed to pass determined by the following methods:-

- (a) From the rainfall and other characteristics of the catchment.
  - (i) By use of an empirical formula applied to that region, or
  - (ii) By a rational method, provided it is possible to evaluate for the region concerned the various factors employed in the method.
- (b) From the hydraulic characteristics of the stream such as cross-sectional area, and slope of the stream allowing for velocity of flow.
- (c) From the records available, if any, of discharges observed on the stream at the site of the bridge, or at any other site vicinity.



## Empirical Methods for Estimation of Flood Discharge:-

In these methods area of basin or catchment is considered mainly. All other factors which influence peak flow are merged in a constant.

A general equation may be followed in the form:-

$$Q = C \cdot M^n$$

Here, Q= Peak Flow or rate of maximum discharge

C= a constant for the catchment

M= area of catchment, and 'n' is an index

The constant for catchment is arrived at, after taking the following factors into account:

### (A) Basin Characteristics

- a) Area
- b) Shape
- c) Slope

### (B) Storm Characteristics

- a) Intensity
- b) Duration
- c) Distribution

### Limitations

These methods do not take frequency of flood into consideration.

These methods cannot be applied universally

Fixing of constant is very difficult and exact theory cannot be put forth for its selection.

## 1) Dicken's Formula

$$Q = C \cdot M^{3/4}$$

Here, Q= Discharge in cum/sec

C= a constant

M= area of catchment in sq .km.

## 2) Ryve's formula

$$Q = C. M^{2/3}$$

Here, Q= Discharge in cum/sec

C= 6.74 for area within 24 km from coast or,

C= 8.45 for areas within 24-161 km from coast or,

C= 10.1 for limited hilly areas

In worst case C goes up to 40.5

M= area of catchment in sq .km.

## 3) Inglis Formula

This formula used only Mahastra state and here three different cases are taken into consideration.

(a) For small areas only (It is also applicable for fan-shaped catchment)

$$Q = 123.2 \sqrt{M}$$

(b) For areas between 160 to 1000 square km.

$$Q = 123.2 \sqrt{M - 2.62(M - 259)}$$

(c) For all type of catchment

$$Q = 123.2 M / \sqrt{(M + 10.36)}$$

In all equations, M= area of catchment in sq .km.

## 4) Nawab Jang Bahadur's Formula :-

$$Q = C (M / 2.59)^{(a - b \cdot \log A)}$$

Here, a, b, and C are constant.

a= 0.993 and b= 1/14

C = 59.5 for North India or,

= 48.1 for South India

## 5) Creager's Formula :-

$$q = C.M^n$$

Here, q=the peak flow per sq. km of a basin

M= area of catchment in sq. km. and 'n' is some index

By multiplying both sides of the above equation are of the basin M, we get

$$Q = C. M^{n+1}$$

Where Q is peak value

Equation given by Creager , Justin and Hinds is

$$Q = 46. CM^{0.849M - 0.048}$$

**6) Khosla's Formula :-**

It is a rational formula, It is based on the equation  $P = R + L$

**Or**  $R = P - L$

Here, R is runoff, P is rainfall and L is losses.

$L = 4.82 T_m$ , where L is in mm and  $T_m$  is in centigrade {in C.G.S. System}

$R = P - 4.82 T_m$

**7) Besson's Formula :-**

This formula is very rational and can be used in any case:

$$Q_m = (P_m \times Q_r) / (P_r)$$

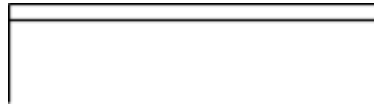

Here,  $Q_m$  = Peak flow expected

$Q_r$  = Some observed peak flow

$P_r$  = Observed rainfall

$P_m$  = expected rainfall

**Rational Methods for Estimation of Flood Discharge:-**

This method is applicable for determination of flood discharge for small culverts only. In order to arrive at a rational approach, a relationship has been established between rainfall and runoff under various circumstances. The size of flood depends upon the following factors.

(i) Climate or Rainfall Factors. This includes

- (a) Intensity (b) Distribution and (c) Duration of Rainfall

(ii) Catchment Area Factors. This includes:

- (a) Catchment Area (b) its slope (c) its shape (d) porosity of soil
- (e) Vegetable cover (f) initial state of wetness

**WATERWAY**

The area through which the water flows under a bridge superstructure is known as the waterway of the bridge. The linear measurement of this area along the bridge is known as the linear waterway. This linear waterway is equal to the sum of all the clear spans. This may be called as artificial linear waterway.

Due to the construction of a bridge the natural waterway gets contracted thereby increasing the velocity of flow under a bridge. This increased velocity results into heading up of water on the upstream of the river or stream, known as Afflux.

**Economic Span:** - the economic span of a bridge is the one which reduces the overall cost of a bridge to be minimum. The overall cost of a bridge depends upon the following factors

- a. Cost of material and its nature.
- b. Availability of skilled labour
- c. Span Length.
- d. Nature of stream to be bridged.
- e. Climatic and other conditions.

**Notes:-**

It is not in the hand of engineers to bring down the cost of living index or price of the materials like cement, steel, timber, etc. but they can help in bringing down the cost of bridges by evolving economical designs.

Considering only variable items, the cost of superstructure increases and that of sub-structure decreases with an increase in the span length. Thus most economic span length is that which stultifies the following :-

i.e. The cost of Super Structure= The cost of the Sub-Structure

**AFFLUX**

When a bridge is constructed, the structure such as abutments and piers cause the reduction of natural waterway area. The contraction of stream is desirable because it leads to tangible saving in the cost specially for alluvial stream whose natural surface width is too large than required for stability. Therefore, to carry the maximum flood discharge, the velocity under a bridge increases. This increased velocity gives rise to sudden heading up of water on the upstream side of the stream. The phenomenon of heading up of water on the upstream side of the stream is known as “**AFFLUX**”

Greater the afflux greater will be the velocity under the downstream side of the bridge and greater will be the depth of scour and consequently greater will be depth of foundations required.

**Afflux is calculated by one of the following formula**

**(A) Marriman’s Formula**

$$h_a = (V^2 / 2g) \{ (A/Ca)^2 - (A/A_1) \}$$

Here,  $h_a$  = Afflux in meters

V= Velocity of approach in meters per second

A= Natural Waterway area at the site

a=Contracted area in square meters

A<sub>1</sub>= The enlarged area upstream of the bridge square meters

C= Coefficient of Discharge =  $0.75+0.35 (a/A)- 0.1(a/A)^2$  approximately

**(A) Molesworth's Formula**

$$h_w = \left[ \frac{V}{1.7} + 0.015 \right] (A/a)^2$$

Here, V, A and a have the same meaning as in the Marrison's Formula

**CLEARANCE**

To avoid any possibility of traffic striking any structural part clearance diagram are specified. The horizontal clearance should be the clear width and vertical clearance of the clear height, available for the passage of vehicular traffic as shown in the clearance diagram in the figure below.

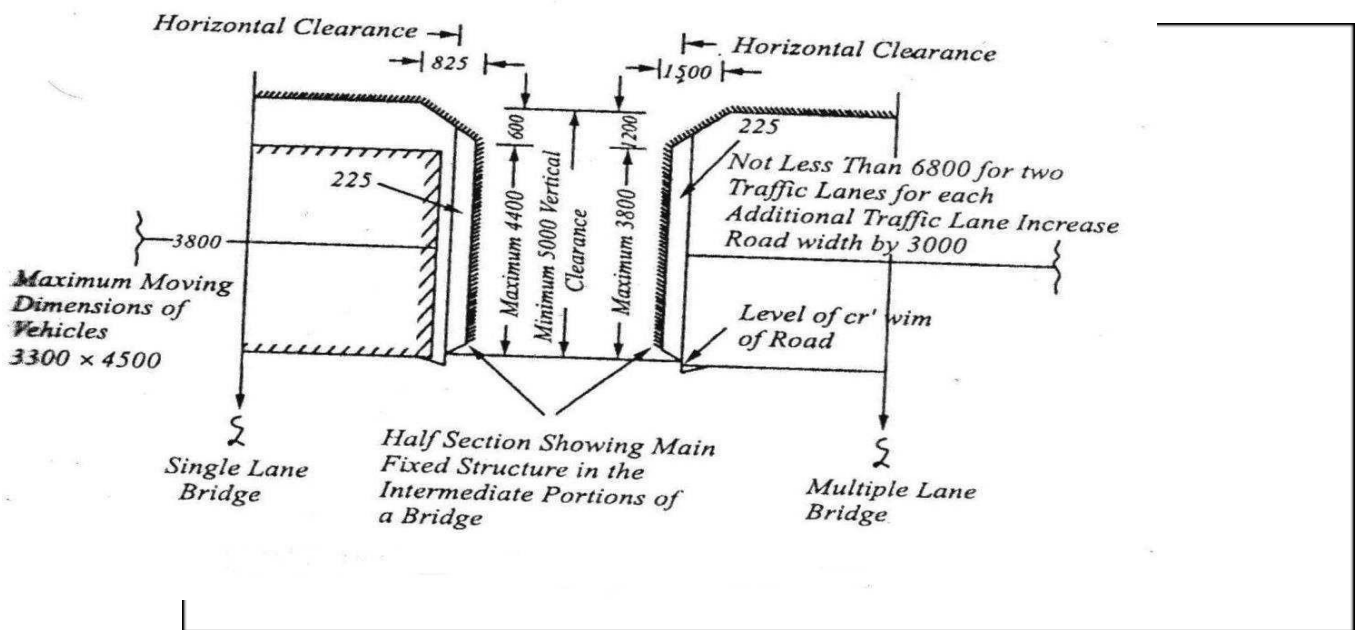

**Clearance Diagram for Road Bridges**

*Note* : - For a bridge constructed on a horizontal curve with superelevated road surfaces, the horizontal clearance should be increased on the side of inner kerb by an amount equal to 5m multiplied by the superelevation. The minimum vertical clearance should be measured from the super elevated level of roadway.

## FREE BOARD

Free board is the vertical distance between the designed high flood level, allowing for the afflux, if any, and level of the crown of the bridge at its lowest point.

It is essential to provide the free board in all types of bridges for the following reasons:-

Free Board is required to allow floating debris, fallen tree trunks and approaches waves top pass under the bridge.

Free board is also required to allow for the afflux during the maximum flood discharge due to contraction of waterway.

Free board is required to allow the vessels to cross the bridges in case of navigable rivers.

The value of free-board depends upon the types of the bridge.

### **Collection of Bridge Design Data: -**

For a complete and proper appreciation of the bridge project the engineer in charge of the investigation should carry out studies regarding its financial, economic, social and physical feasibility. The detailed information to be collected may cover loading to be used for design based on the present and anticipated future traffic, hydraulic data based on stream characteristics, geological data, subsoil data, climatic data, alternative sites, aesthetics, cost etc.

The following drawings containing information as indicated should be prepared

1. INDEX MAP
2. CONTURE SURVEY PLAN
3. SITE PLAN
4. CROSS-SECTION
5. LONGITUDINAL SECTION
6. CATCHEMENT AREA MAP
7. SOIL PROFILE

### **Design data for major bridge:-**

#### **A- General data:-**

- (i) Name of the road and its classification.
- (ii) Name of the stream.
- (iii) Location of nearest G.T.S. bench mark and its reduced level.
- (iv) Chainage at centre line of the stream.
- (v) Existing arrangement for crossing the stream.
  - a)                                      During Monsoon                      b) During dry season
- (vi)                                      Liability of the site to earthquake disturbance

**B- Catchment Area and Run Off Data:-**

- (i) Catchment Area
  - (a) Hilly Area
  - (b) In plains
- (ii) Maximum recorded intensity and frequency of rainfall in catchment.
- (iii) Rainfall in centimeter per year in a season
- (iv) Length of catchment in kilometres.
- (v) Width of catchment in kilometres.
- (vi) Longitudinal slope of catchment.
- (vii) Cross slope of catchment.
- (viii) The nature of catchment and its shape.

**C- Data Regarding Nature of Stream**

**Sub-Surface Investigation:-**

Sub-Surface investigation is essential for to know the properties of the bridge site soil. The field and laboratory investigations required to obtain the necessary soil data for the design are called soil exploration.

The principal requirements of a complete investigation can be summarized as follows:-

1. Nature of the soil deposits up to sufficient depth.
2. Depth, thickness and composition of each soil stratum.
3. The location of ground water.
4. Depth to rock and composition of rock.
5. The engineering properties of soil and rock strata that affect the design of the structure.

In exploration programme the extent of distribution of different soils both in the horizontal and vertical directions can be determined by the following methods:

1. By use of open pits.
2. By making bore holes and taking out samples.
3. By Soundings.
4. By use of geophysical methods.

**Equipments for laboratory Work:-**

The disturbed soil sample as taken from bed level to scour level at every one meter interval or at depths wherever strata changes are tested to determine the following properties:-

1. Liquid Limit, Plastic Limit and Plasticity Index
2. Organic Content
3. Harmful Salts
4. Sieve Analysis
5. Silt Factor

The undisturbed soil samples as taken below the scour level to a level where the pressure is about 5% of the pressure at the base are tested to determine

1. Particle size analysis.
2. Values of cohesion and angle of internal friction by shear test.
3. Compression index and pre-consolidation pressure by consolidation test.
4. Density specific gravity and moisture content.

**Advantage of Sub-Surface Investigation:-**

There are manifold advantages of carefully planned investigation programme. These can be summarized as below:-

1. A suitable and economical solution can be worked out.
2. The construction schedule can be properly planned.
3. The extent and nature of difficulties likely to be met with can be determined.
4. The rate and amount of settlements can be determined.
5. The variation in the water –table, of the presence of artesian pressures can be found out.



## CHAPTER 9

### Depth of Scour:-

DEPTH OF SCOUR (D) is the depth of the eroded bed of the river, measured from the water level for the discharge considered. Well-laid foundation is mostly provided in road and railway bridges in India over large and medium-sized rivers. The age-old Lacey–Inglis method issued for estimation of the design scour depth around bridge elements such as pier, abutment, guide bank, spur and groyene. Codal provisions are seen to produce too large a scour depth around bridge elements resulting in bridge sub-structures that lead to increased construction costs. Limitations that exist in the codes of practice are illustrated in this paper using examples. The methods recently developed for estimation of the scour are described. New railway and road bridges are required to be built in large numbers in the near future across several rivers to strengthen such infrastructure in the country. It is strongly felt that provisions in the existing codes of practice for determination of design scour depth require immediate review. The present paper provides a critical note on the practices followed in India for estimating the design scour depth.

Indian practices on estimation of design scour depth

1. Lacey–Inglis method

2. Comments on Lacey’s method

- The probable maximum depth of scour for design of foundations and training and protection works shall be estimated considering local conditions.
- Wherever possible and especially for flashy rivers and those with beds of gravel or boulders, sounding for purpose of determining the depth of scour shall be taken in the vicinity of the site proposed for the bridge. Such soundings are best taken during or immediately after a flood before the scour holes have had time to silt up appreciably. In calculating design depth of scour, allowance shall be made in the observed depth for increased scour resulting from:

(i) The design discharge being greater than the flood discharge observed.

(ii) The increase in velocity due to the constriction of waterway caused by construction of the bridge.

(iii) The increase in scour in the proximity of piers and abutments.

- 4.6.3 In the case of natural channels flowing in alluvial beds where the width of waterway provided is not less than Lacey’s regime width, the normal depth or Scour (D) below the foundation design discharge ( $Q_f$ ) level may be estimated from Lacey’s formula as indicated below

$$D = 0.473 (Q_f^3 / f)^{1/3}$$

Where D is depth in metres  $Q_f$  is in cumecs and ‘f’ is Lacey’s silt factor for representative sample of bed material obtained from scour zone.

- Where due to constriction of waterway, the width is less than Lacey’s regime width for  $Q_f$  or where it is narrow and deep as in the case of incised rivers and has sandy bed, the normal depth of scour may be estimated by the following formula:

$$D = 1.338 (Q_f^2 / f)^{1/2}$$

Where 'Q<sub>f</sub>' is the discharge intensity in cubic metre per second per metre width and f is silt factor  
 The silt factor 'f' shall be determined for representative samples of bed material collected from scour zone using the formula :  $f = 1.76 \sqrt{m}$  where m is weighted mean diameter of the bed material particles in mm.

Values of 'f' for different types of bed material commonly met with are given below :

Type of bed	Material Weighted mean dia of particle(mm)	Value of 'f'
(i) Coarse silt	0.04	0.35
	0.08	0.50
(ii) Fine sand	0.15	0.68
	0.3	0.96
(iii) Medium sand	0.5	1.24
	0.7	1.47
	1.0	1.76
(iv) Coarse sand	2.0	2.49

The depth calculated (vide clause 4.6.3 and 4.6.4 above) shall be increased as indicated below, to obtain maximum depth of scour for design of foundations, protection works and training works:-







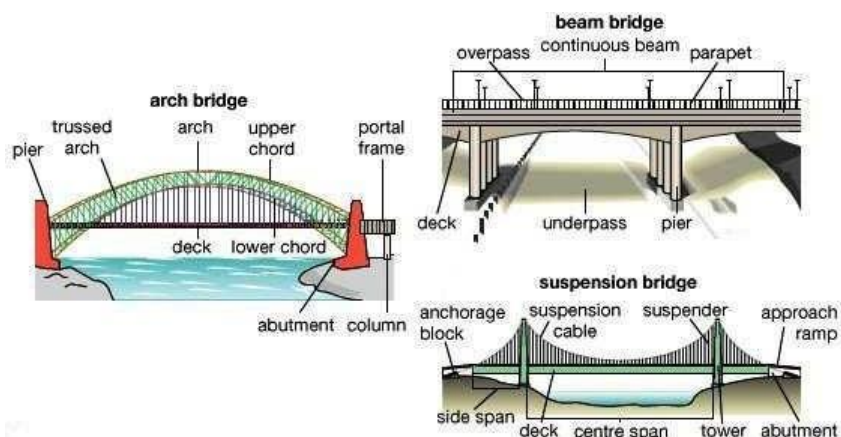

Nature of the river	Depth of scour
In a straight reach	1.25D
At the moderate bend conditions e.g. along apron of guide bund	1.5D
At a severe bend	1.75D
At a right angle bend or at nose of piers	2.0D
In severe swirls e.g. against mole head of a guide bund.	2.5 to 2.75D









In case of clayey beds, wherever possible, maximum depth of scour shall be assessed from actual observations.











### Types of Bridge











Types of Bridge

<p>Arch bridge</p>	
<p>Arch bridge (concrete)</p>	
<p>Through arch bridge</p>	
<p>Beam bridge</p>	
<p>Log bridge (beam bridge)</p>	
<p>Cavity wall Viaduct</p>	
<p>Bowstring arch</p>	
<p>Box girder bridge</p>	

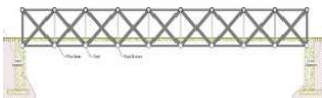
<p><u>Cable-stayed bridge</u></p>	
<p><u>Cantilever bridge</u></p>	
<p><u>Cantilever spar cable-stayed bridge</u></p>	
<p><u>Clapper bridge</u></p>	
<p><u>Covered bridge</u></p>	
<p><u>Girder bridge</u></p>	
<p>Continuous span girder bridge</p>	
<p><u>Moon bridge</u></p>	
<p><u>Movable bridge</u></p>	

<p><u>Pigtail bridge</u></p>	
<p><u>Plate girder bridge</u></p>	
<p><u>Pontoon bridge</u></p>	
<p><u>Roving bridge</u></p>	
<p><u>Segmental bridge</u></p>	
<p><u>Self-anchored suspension bridge</u></p>	
<p><u>Side-spar cable-stayed bridge</u></p>	
<p><u>Simple suspension bridge (Inca rope bridge)</u></p>	
<p><u>Step-stone bridge</u></p>	
<p><u>Stressed ribbon bridge</u></p>	
<p><u>Suspension bridge</u></p>	

<p><u>Transporter bridge</u></p>	
<p><u>Trestle</u></p>	
<p><u>Truss arch bridge</u></p>	
<p><u>Truss bridge</u></p>	
<p><u>Vierendeel bridge</u></p>	
<p><u>Brown truss</u></p>	
<p><u>Covered bridge</u></p>	
<p><u>Lattice truss bridge</u> (Town lattice truss)</p>	
<p><u>Tubular bridge</u></p>	

**Bridge Foundation:-**

**Definition:-** A foundation is the part of the structure which is in direct contact with the ground. It transfers the load of the structure to the soil below. Before deciding upon its size, we must ensure that:

- (i) The bearing pressure at the base does not exceed the allowable soil pressure.
- (ii) The settlement of foundation is within reasonable limits
- (iii) Differential settlement is to limited as not to cause any damage to the structure.

Broadly, foundation may be classified under two categories i.e.

1. Shallow foundation
2. Deep Foundation

Shallow Foundation:-According to Trezaghi, a foundation is said to be shallow if its depth is equal or less than its width.

Deep Foundation:- According to Trezaghi, a foundation is said to be deep , the depth is greater than its width and it cannot be prepared by open excavation.

#### Types of Bridge Foundation:-

The selection of foundation type suitable for a particular site depends on the following considerations:-

- 1 ) Nature of Subsoil
- 2) Nature and extent of difficulties, e.g. presence of boulder, buried tree trunks, etc. Likely to be met with, and
- 3) Availability of expertise and equipment.

Depending upon their nature and depth, bridge foundation can be categories as follows:

- i. Open Foundation,**
- ii. Raft Foundation,**
- iii. Pile Foundation,**
- iv. Well foundation,**

#### (i)Open Foundation in Bridges:-

1. An open foundation or spread foundation is a type of foundation and can be laid using open excavation by allowing natural slopes on all sides.
2. This type of foundation is practicable for a depth of about 5m and is normally convenient above the water table.
3. The base of the pier or abutment is enlarged or spread to provide individual support.
4. Since spread foundations are constructed in open excavation, therefore, they are termed as open foundation.
5. This type of foundation is provided for bridges of moderate height built on sufficiently firm day ground.
6. The piers in such cases are usually made with slight batter and provided with footings widened at bottom. Where the ground is not stiff the bearing surface is further extended by a wide layer of concrete at bottom (see the figure).

#### (ii) Raft Foundation:-

1. A raft foundation or mat is a combined footing that covers the entire area beneath a bridge and supports all the piers and abutments.
2. When the allowable soil pressure is low, or bridge loads are heavy, the use of spread footing would cover more one-half of the area, and it may prove more economical to use raft foundation
3. They are also used where the soil mass contains compressible lenses so that the differential settlement would be difficult to control.
4. The raft tends to bridge over the erratic deposits and eliminates the differential settlement.

5. Raft foundation is also used to reduce the settlement above highly compressible soils by making the weight of bridge and raft may undergo large settlement without causing harmful differential settlement. For this reason, almost double settlement of that permitted for footings is acceptable for rafts.
6. Usually when hard soil is not available within 1.5 to 2.5 m a raft foundation is adopted.
7. The raft is composed of reinforced concrete beams a relatively thin slab underneath, figure

**(iii)Pile foundation in Bridges:-**

1. The pile foundation is constructions for the foundation of a bridge pier or abutment supported on piers.
2. A pile is an element of construction composed of timber, concrete or steel or combination of them.
3. Pile foundation may be defined as a column support type of foundation which may be cast-in-situ or precast.
4. The piles may be place separately or they may be placed in form of a cluster throughout the length of the pier or abutment.
5. This type of construction is adopted when the loose soil extends to great depth.
6. The load of the bridge is transmitted by the piles to hard stratum below or it is resisted by the friction developed on the sides of piles.

**Classification of piles:-**

Piles are broadly classified into two categories:-

- i- Classification based on the function
- ii- Classification based on the materials and composition

**Classification based on the function**

- Bearing Pile.
- Friction Pile.
- Screw Pile.
- Compaction Pile.
- Uplift Pile.
- Batter Pile.
- Sheet Pile.

**Classification based on the function**

- Cement concrete piles.
- Timber Piles.
- Steel Piles.
- Sand Piles.
- Composite Piles.



**(iv) Well Foundation in bridges**

- a) Well foundations are commonly used for transferring heavy loads to deep strata in river or sea bed for bridges, transmission towers and harbour structures. The situation where well foundations are resorted are as below
  - a) Wherever consideration of scour or bearing capacity require foundation to be taken to depth of more than 5 M below ground level open foundation becomes uneconomical. Heavy excavation and dewatering problem coupled with effort involve in retaining the soil makes the open foundation costlier in comparison to other type of foundation.
  - b) Soil becomes loose due to excavation around the open foundation and hence susceptible to scouring. This is avoided in well foundation which is sunk by dredging inside of the well.
  - c) From bearing pressure considerations, a well foundation can always be left hollow thereby considerably reducing bearing pressure transmitted to the foundation material. This is very important in soils of poor bearing capacity, particularly in clayey soils. In other type of foundation, the soil displaced is occupied by solid masonry/concrete which are heavier than the soil displaced and hence this does not give any relief in respect of adjusting bearing capacity. However in case of well foundation this is easily achieved because of cellular space left inside the well. -

Caisson:-

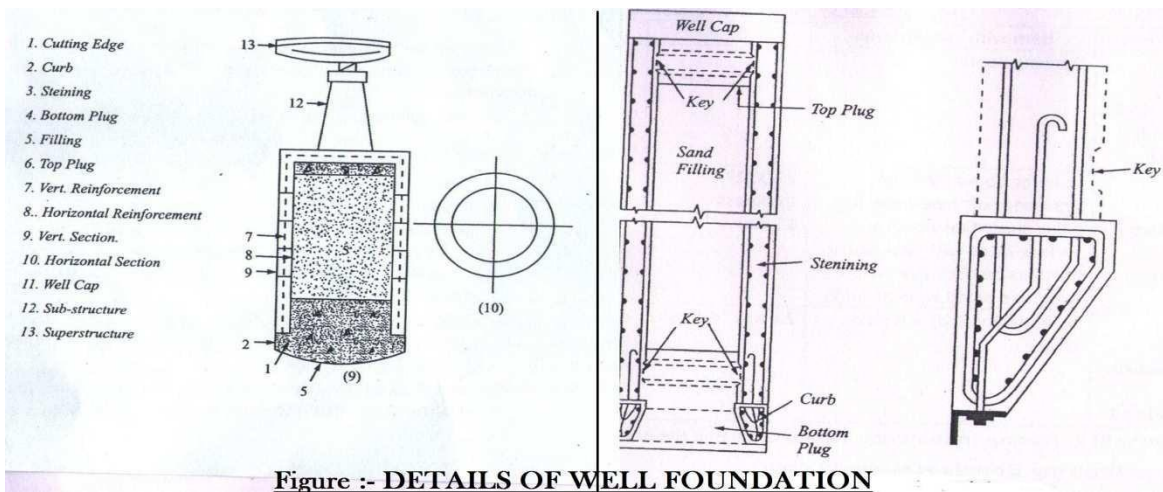

**Figure :- DETAILS OF WELL FOUNDATION**

Caisson: - The caisson is a structure used for the purpose of placing as foundation in correct position under water. The term caisson is derived from the French word ‘caisse’ meaning a box. It is a member with hollow portion, which after installing in place by any means is filled with concrete or other material. Caissons are prepared in sandy soils the caissons can be divided in the following three groups

- a. Box Caissons
- b. Open Caissons or Wells
- c. Pneumatic Caissons

### **Well components and their functions:**

**Cutting edge:** - It provides a comparatively sharp edge to cut the soil below during sinking operation. It usually consists of a mild steel equal angle of side 150mm.

**Curb:** - It has a two-fold purpose. During sinking it acts as an extension of cutting edge and also provided support to the well steining and bottom plug while after sinking it transfers the load to the soil below. It is made up of reinforced concrete using controlled concrete of grade M200.

**Steining:-** It is the main body of the well. It serves dual purpose. It acts as a cofferdam during sinking and structural member to transfer the load to the soil below afterwards. The steining may consist of brick masonry or reinforced concrete. The thickness of steining should not be less than 4.5 cm not less than that given by equation.

$$t = K \{ (H/100) + (D/10) \}$$

Here,  $t$  = minimum concrete steining thickness.

H= well depth below bed

D= External diameter of Well

K= a constant which is 1.0 for sandy strata.

Bottom Plug: - Its main function is to transfer load from the steining to the soil below.

Sand Plug: - Its utility is doubtful. It is supposed to afford some relief to the steining by transferring directly a portion of load from well cap to bottom plug.

Top Plug: - The opinion is divided about the top plug. It, at least, serves as a shuttering for laying well cap.

Reinforcement: – It provides requisite strength to the structure during sinking and



service.

Well Cap: - It is needed to transfer the loads and moments from the pier to the well or wells below. The shape of well cap is similar to that of the well with a cantilevering of about 15cm. Whenever 2 or 3 wells of small diameter are needed to support the sub-structure, the well cap designed as a slab resting over the well or wells with partial fixity at the edges of the wells.

Depth of Well Foundation:- As per I.R.C. Bridge Code (Part-III), the depth of well foundation is to be decided on the following consideration

1. The minimum depth of foundation below the H.F.L. should be  $1.33D$ , Where  $D$  is the anticipated max. Depth of scour below H.F.L. Depth should provided proper grip according to some rational formula.
2. The max bearing pressure on the subsoil under the foundation resulting form any combination of the loads and forces except wind and seismic forces should not exceed the safe bearing capacity of the subsoil, after taking into account the effect of scour.

With wind and seismic forces in addition, the max. Bearing pressure should not exceed the safe bearing capacity of the subsoil by more than 25%.

3. While calculating max. Baring pressure on the foundation bearing layer resulting from the worst combination of direct forces and overturning moments, the effect of a passive resistance of the earth on sides of the foundation structure may be taken into account below the max, depth of the scour only.
4. The effect of skin friction may be allowed on the portions below the max, depth of scour. Accordingly for deciding the depth of well foundation, we require correct estimation of the following.
  1. Max. Sour depth.
  2. Safe bearing capacity.
  3. Skin friction.
  4. Lateral earth support below max. Scour level.

It is always desirable to fix the level of a well foundation on a sandy strata with adequate bearing capacity. Whenever a thin stratum of clay occurring between two layers of sand is met with, in that case well must be pierced through the clayey strata. If at all foundation has to be laid on clayey layer it should be ensured that the clay is stiff.

Design loads and Forces. The forces acting on a bridge structure, to be considered for the design of a well foundation, are as follows:

Vertical

- (i) Dead load,
- (ii) Live load,
- (iii) Buoyancy.

## Horizontal

- (i) Wind force.
- (ii) Force due to water currents.
- (iii) Longitudinal forces caused by the tractive effort of vehicle or by braking effect of vehicles.
- (iv) Longitudinal force on account of resistance of the bearing against movement due to variations of temperature.
- (v) Seismic force.
- (vi) Earth pressure.
- (vii) Centrifugal force.

The I.R.C. Bridge code II stipulates the magnitude of above loads and forces. The magnitude, direction and point of application of all the above forces can be resolved into two horizontal forces, P and Q and a single vertical force W under the worst possible combinations.

## Chapter 10

### Piers:-

Piers provide vertical supports for spans at intermediate points and perform two main functions: transferring superstructure vertical loads to the foundations and resisting horizontal forces acting on the bridge. Although piers are traditionally designed to resist vertical loads, it is becoming more and more common to design piers to resist high lateral loads caused by seismic events. Even in some low seismic areas, designers are paying more attention to the ductility aspect of the design. Piers are predominantly constructed using reinforced concrete. Steel, to a lesser degree, is also used for piers. Steel tubes filled with concrete (composite) columns have gained more attention recently.



**FIGURE: 1 : Typical cross-section shapes of piers for overcrossings or viaducts on land.**

Pier is usually used as a general term for any type of substructure located between horizontal spans and foundations. However, from time to time, it is also used particularly for a solid wall in order to distinguish it from columns or bents. From a structural point of view, a column is a member that resists the lateral force mainly by flexure action whereas a pier is a member that resists the lateral force mainly by a shear mechanism. A pier that consists of multiple columns is often called a bent.

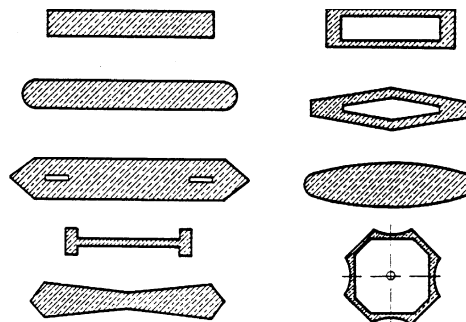

**FIGURE:-2 Typical cross-section shapes of piers for river and waterway crossings.**

There are several ways of defining pier types. One is by its structural connectivity to the superstructure: monolithic or cantilevered. Another is by its sectional shape: solid or hollow; round, octagonal, hexagonal, or rectangular. It can also be distinguished by its framing configuration: single or multiple columns bent; hammerhead or pier wall. Selection of the type of piers for a bridge should be based on functional, structural, and geometric requirements. Aesthetics is also a very important factor of selection since modern highway bridges are part of a city's landscape. Figure-1 shows a collection of typical cross section shapes for overcrossings and viaducts on land and Figure-2 shows some typical cross section shapes for piers of river and waterway crossings. Often, pier types are mandated by government agencies or owners. Many state departments of transportation in the United States have their own standard column shapes.

Broadly piers are classified under following two categories:-

- I. Solid Piers.
- II. Open Piers.

**Solid wall piers**, as shown in Figures 3-a and 4, are often used at water crossings since they can be constructed to proportions that are both slender and streamlined. These features lend themselves well for providing minimal resistance to flood flows.

**Hammerhead piers**, as shown in Figure 3-b, are often found in urban areas where space limitation is a concern. They are used to support steel girder or precast prestressed concrete superstructures. They are aesthetically appealing. They generally occupy less space, thereby providing more room for the traffic underneath. Standards for the use of hammerhead piers are often maintained by individual transportation departments. A column bent pier consists of a cap beam and supporting columns forming a frame.

**Column bent piers**, as shown in Figure 3-c and Figure 27.5, can either be used to support a steel girder superstructure or be used as an integral pier where the cast-in-place construction technique is used. The columns can be either circular or rectangular in cross section. They are by far the most popular forms of piers in the modern highway system.

**A pile extension pier** consists of a drilled shaft as the foundation and the circular column extended from the shaft to form the substructure. An obvious advantage of this type of pier is that it occupies minimal amount of space. Widening an existing bridge in some instances may require pile extensions because limited space precludes the use of other types of foundations.

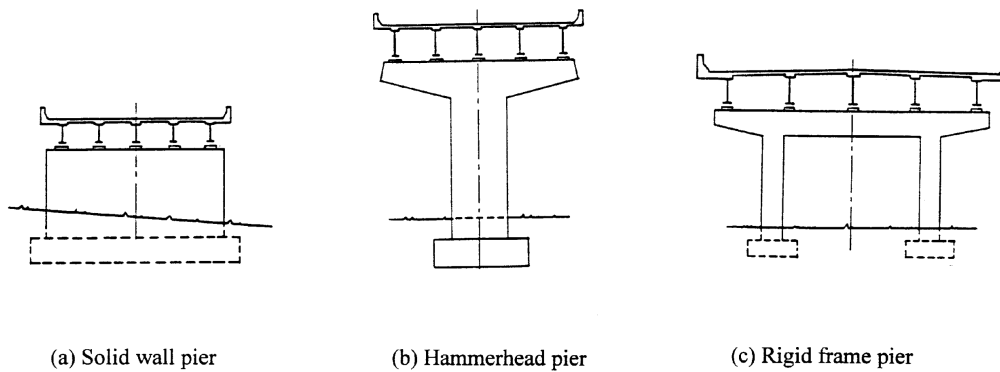

**FIGURE-3**

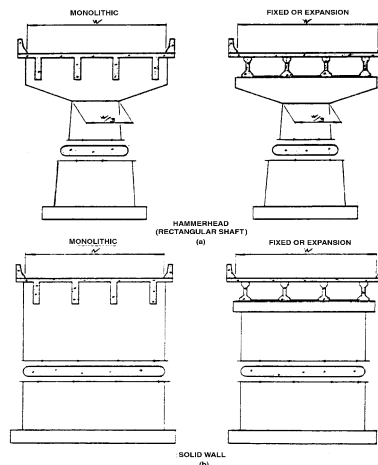

**FIGURE-4**

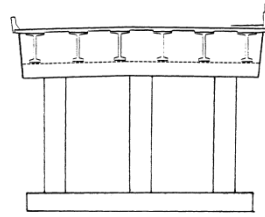

(a) Bent for precast girders

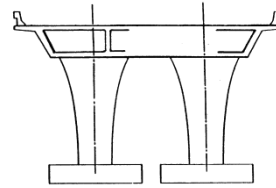

(b) Bent for cast-in-place girders

### **Abutments:-**

They are the end supports of the superstructure, retaining earth on their back. They are built either with masonry, stone or brick work or ordinary mass concrete or reinforced concrete. The top surface of the abutment is made flat when the superstructure is of trusses or girders or semi-circular arch. In case of segmental or elliptical arch type of superstructure, the abutment top is made skew. Weep holes are provided at different levels through the body of the abutment to drain of the retained earth.

The salient features of bridge abutments are listed below.

- (a) Height. The height of the abutments is kept equal to that of the piers.
- (b) Abutment batter. The water face of the abutment is usually kept vertical or could be given a batter of 1 in 12 to 1 in 24 as of piers. The face retaining earth is given a batter of 1 in 6 or may be stepped down.
- (c) Abutment Width. The top width of the abutment should provide enough space for the bridge seat and for the construction of a dwarf wall to retain earth up to the approach level.
- (d) Length of Abutment. The length of abutment is kept at least equal to the width of the bridge.
- (e) Abutment cap. The design is similar to that of pier cap.

Abutments can be spill-through or closed. The spill through abutment generally has a substantial berm to help restrain embankment settlement at the approach of the structure.

Approach embankment settlement can also be accommodated by approach slabs to eliminate bumps at the bridge ends, closed abutments partially or completely retain the approach embankments from spilling under the span, and Bridges of several spans require expansion at the abutments. Therefore they are not usually required to resist the longitudinal forces that develop.

Broadly, abutments are classified under the following categories.

1. Abutments with wing walls
2. Abutments without wing walls

#### Abutments with wing walls

- (a) Straight Wing walls
- (b) Splayed Wing walls
- (c) Return Wing

#### Walls Abutments without wing walls

- (a) Buried Abutments
- (b) Box Abutments
- (c) Tee Abutments



(d) Arch Abutments

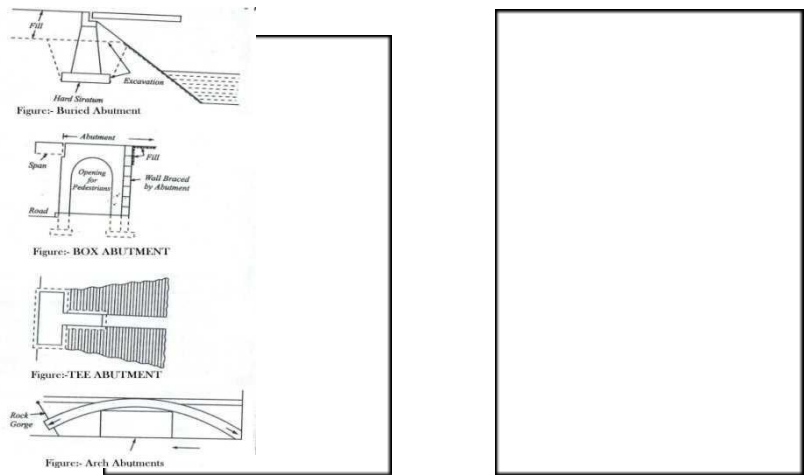

**FIGURES: - ABUTMENTS**

**Buried Abutments:** - This type of abutments is generally built prior to the placing of the fill. Since it is filled on both sides the earth pressure is low. Superstructure erection can be begin before placement of fill .

**Box Abutments:** - This employs a short span of bridge built integral with columns to act as a frame and resist earth pressure of the approaches. It is most often used overpass work where the short span may be employed for pedestrian passage (see figure).

**Tee Abutments:** - This type looks like T in plan and has now become absolute (see figure)

**Arch Abutments:** - This type of abutment is used where arches are employed because of their economy in certain conditions. The high inclined skewback thrusts are difficult to handle unless the abutment can be seated in rock. Therefore, they are often used for span over gorges. (see figure)

**WING WALLS:**

In a bridge, the wing walls are adjacent to the abutments and act as retaining\_walls. They are generally constructed of the same material as those of abutments. The wing walls can either be attached to the abutment or be independent of it. Wing walls are provided at both ends of the abutments to retain the earth filling of the approaches. Their design period depends upon the nature of the embankment and does not depend upon the type or parts of the bridge.<sup>[1]</sup>

The soil and fill supporting the roadway and approach embankment are retained by the wing walls, which can be at a right angle to the abutment or splayed at different angles. The wing walls are generally constructed at the same time and of the same materials as the abutments.

**Classification of wing walls**

Wing walls can be classified according to their position in plan with respect to banks and abutments. The classification is as follows:

1. **Straight Wing walls:** They are used for small bridges, on drains with low banks and for railway bridges in cities (weep holes are provided).
2. **Splayed Wing walls:** These are used for bridges across rivers. They provide smooth entry and exit to the water. The splay is usually 45°. Their top width is 0.5 m, face batter 1 in 12 and back batter 1 in 6, weep holes are provided.
3. **Return Wing walls:** They are used where banks are high and hard or firm. Their top width is 1.5 m and face is vertical and back battered 1 in 4. Scour can be a problem for wing walls and abutments both, as the water in the stream erodes the supporting soil.<sup>1</sup>

# CHAPTER-11

## PERMANENT BRIDGES

### Masonry Bridges:-

Bridge unit the spandrel, which supports the bridge roadway. The spandrel is made from gravel or crushed stone backing held in by lateral (side) walls made of concrete masonry or stonework or in the form of an open main load-bearing structures are made of natural stone, brick, or concrete blocks. Such a bridge is always arched, with massive supports. The main load-bearing element of a masonry bridge is the arch, over which is structure of small arches resting on crosswalk. The advantages of a masonry bridge are its architectural attractiveness and its durability. Masonry bridges are known that have been in use for more than 1,000 years. The basic short comings that limit the use of masonry bridges are their complexity and labor intensiveness of construction.. Their simplicity, economy and ease with which pleasing appearance can be obtained make them suitable for this purpose.

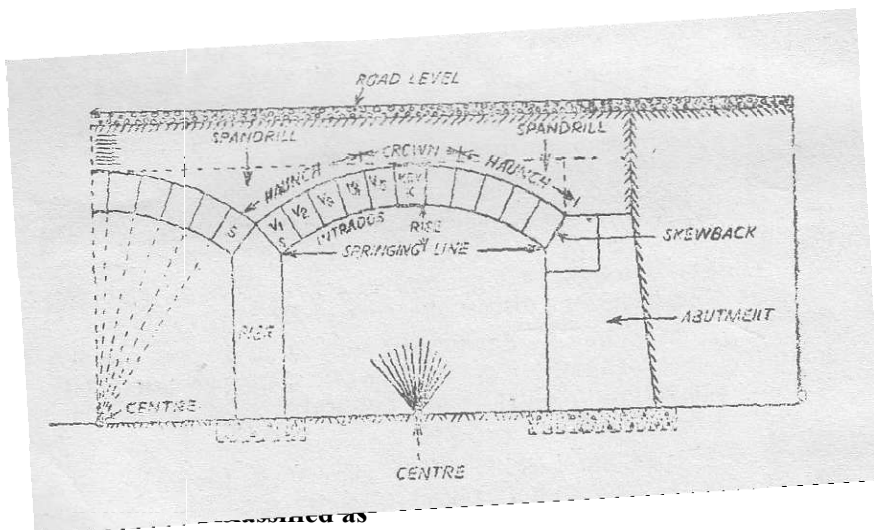

he main structural

- Highway or road bridges
- Railway or rail bridges
- Road - cum - rail bridges

### Classification based on the main structural system

Many different types of structural systems are used in bridges depending upon the span, carriageway width and types of traffic. Classification, according to makeup of main load carrying system, is as follows:

(i) **Girder bridges** - Flexure or bending between vertical supports is the main structural action in this type. Girder bridges may be either solid web girders or truss girders or box girders. Plate girder bridges are adopted for simply supported spans less than 50 m and box girders for continuous spans up to 250 m. Cross sections of a typical plate girder and box girder bridges are shown in Fig.7.2 (a) and Fig. 7.2(b) respectively. Truss bridges [See Fig.7. 2(c)] are suitable for the span range of 30 m to 375 m. Cantilever bridges have been built with success with main spans of 300 m to 550 m. . They may be further, sub-divided into simple spans, continuous spans and suspended-and-cantilevered spans, as illustrated in Fig.7. 3.

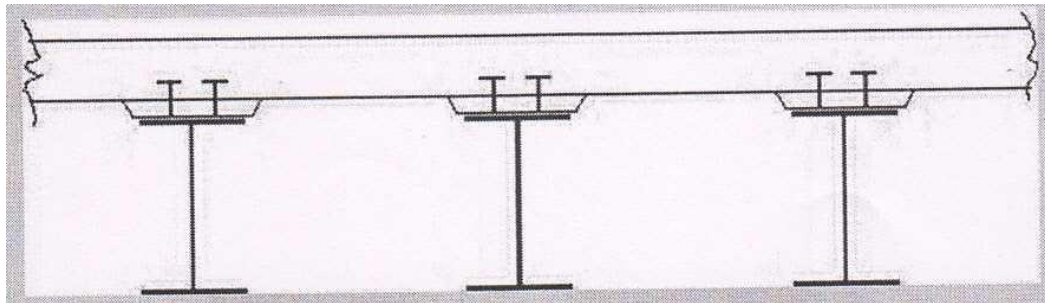

Fig.7.2 (a) Plate girder bridge section

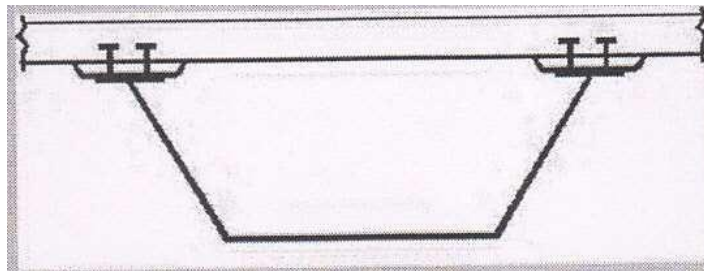

Fig.7.2 (b) Box girder bridge section

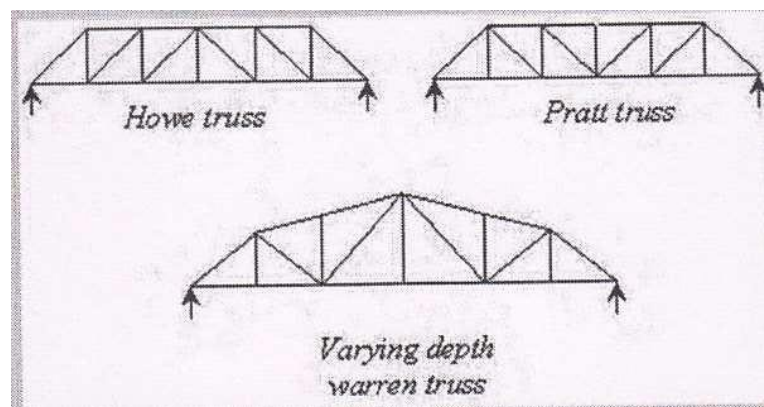

Fig.7.2 (c) Some of the trusses used in steel bridges

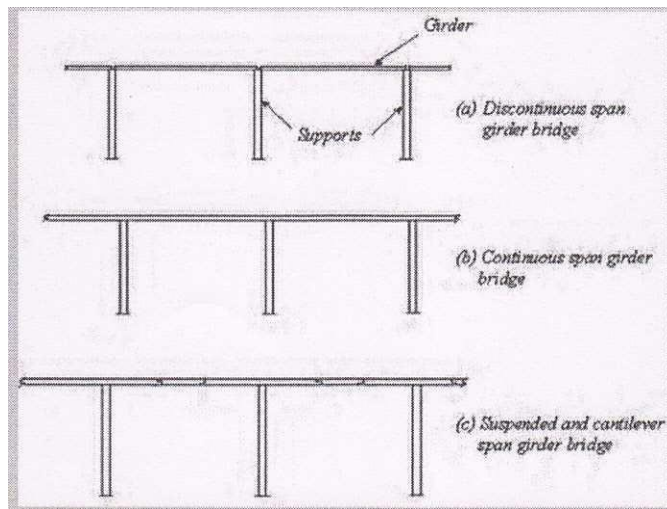

Fig.7.3 Typical girder bridges

(ii) **Rigid frame bridges** - In this type, the longitudinal girders are made structurally continuous with the vertical or inclined supporting member by means of moment carrying joints [Fig.7.4]. Flexure with some axial force is the main forces in the members in this type. Rigid frame bridges are suitable in the span range of 25 m to 200 m.

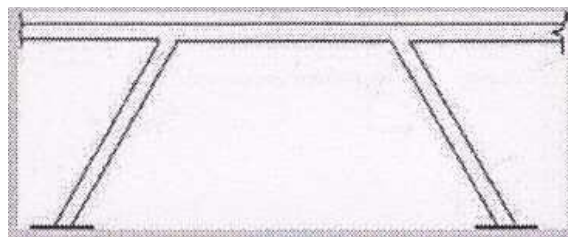
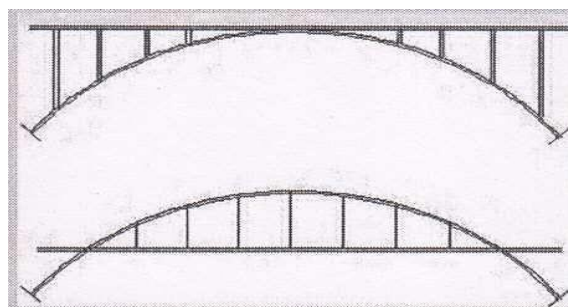

Fig.7.4 Typical rigid frame bridge

(iii) **Arch bridges**

The loads are transferred to the foundations by arches acting as the main structural element. Axial compression in arch rib is the main force, combined with some bending. Arch bridges are competitive in span range of 200 m to 500 m.



(iv) **Cable stayed bridges** - Cables in the vertical or near vertical planes support the main longitudinal girders. These cables are hung from one or more tall towers, and are usually anchored at the bottom to the

girders. Cable stayed bridges are economical when the span is about 150 m to 700 m. Layout of cable stayed bridges are shown in Fig. 7.6.

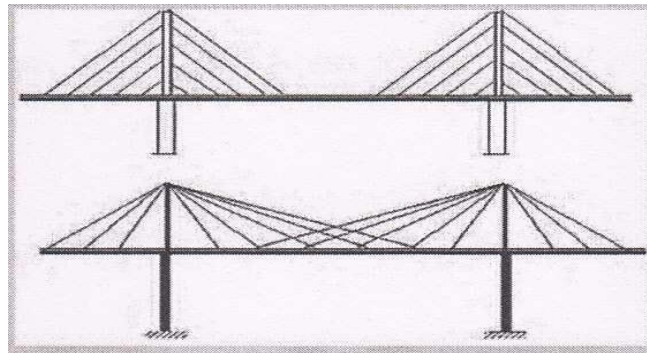

Fig.7.6 Layout of cable stayed bridges

(v) **Suspension bridges** - The bridge deck is suspended from cables stretched over the gap to be bridged, anchored to the ground at two ends and passing over tall towers erected at or near the two edges of the gap. Currently, the suspension bridge is best solution for long span bridges. Fig. shows a typical suspension bridge. Fig. 7.8 shows normal span range of different bridge types.

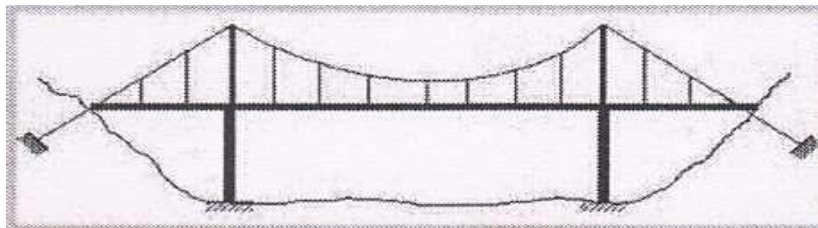

Fig.7.7 Suspension bridge

**Classification based on the position of carriageway**

The bridges may be of the "deck type", "through type" or "semi-through type". These are described below with respect to truss bridges:

(i) **Deck type bridge** -The carriageway rests on the top of the main load carrying members. In the deck type plate girder bridge, the roadway or railway is placed on the top flanges. In the deck type truss girder bridge, the roadway or railway is placed at the top chord level as shown in Fig. 7.9(a).

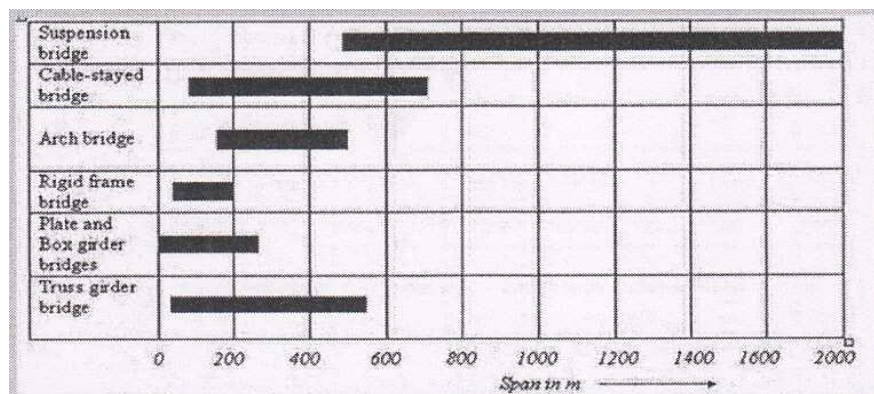
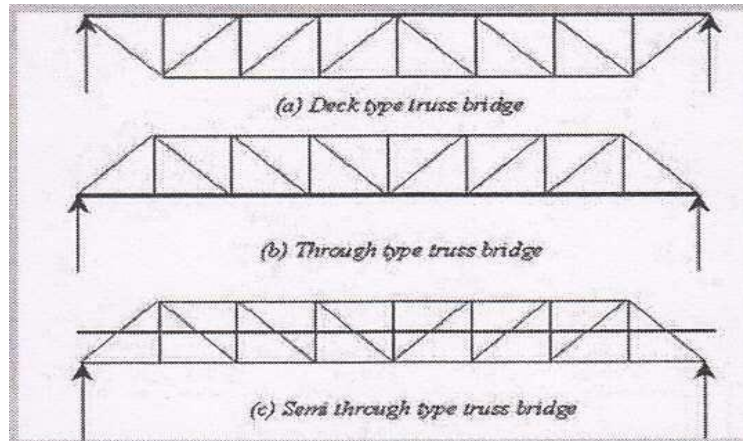

Fig.7.8 Normal span ranges of bridge system



### TYPES OF CONCRETE BRIDGES

#### Arch Bridges

Arch bridges derive their strength from the fact that vertical loads on the arch generate compressive forces in the arch ring, which is constructed of materials well able to withstand these forces. The compressive forces in the arch ring result in inclined thrusts at the abutments, and it is essential that arch abutments are well founded or buttressed to resist the vertical and horizontal components of these thrusts. If the supports spread apart the arch falls down. Traditionally, arch bridges were constructed of stone, brick or mass concrete since these materials are very strong in compression and the arch could be configured so that tensile stresses did not develop. Modern concrete arch bridges utilize prestressing or reinforcing to resist the tensile stresses which can develop in slender arch rings.

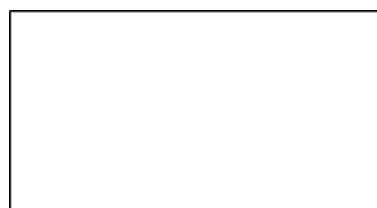

#### Reinforced Slab Bridges

For short spans, a solid reinforced concrete slab, generally cast in-situ rather than precast, is the simplest design. It is also cost-effective, since the flat, level soffit means that false work and formwork are also simple. Reinforcement, too, is uncomplicated. With larger spans, the reinforced slab has to be thicker to carry the extra stresses under load. This extra weight of the slab itself then becomes a problem, which can be solved in one of two ways. The first is to use prestressing techniques and the second is to reduce the deadweight of the slab by including 'voids', often expanded polystyrene cylinders. Up to about 25m span, such voided slabs are more economical than prestressed slabs.



### **Beam and Slab Bridge**

Beam and slab bridges are probably the most common form of concrete bridge in the UK today, thanks to the success of standard precast prestressed concrete beams developed originally by the Prestressed Concrete Development Group (Cement & Concrete Association) supplemented later by alternative designs by others, culminating in the Y-beam introduced by the Prestressed Concrete Association in the late 1980s.

They have the virtue of simplicity, economy, wide availability of the standard sections, and speed of erection. The precast beams are placed on the supporting piers or abutments, usually on rubber bearings which are maintenance free. An in-situ reinforced concrete deck slab is then cast on permanent shuttering which spans between the beams.

The precast beams can be joined together at the supports to form continuous beams which are structurally more efficient. However, this is not normally done because the costs involved are not justified by the increased efficiency.



Simply supported concrete beams and slab bridges are now giving way to integral bridges which offer the advantages of less cost and lower maintenance due to the elimination of expansion joints and bearings.

Techniques of construction vary according to the actual design and situation of the bridge, there being three main types:

1. Incrementally launched
2. Span-by-span
3. Balanced cantilever

#### **Incrementally launched**

As the name suggests, the incrementally launched technique creates the bridge section by section, pushing the structure outwards from the abutment towards the pier. The practical limit on span for the technique is around 75m.

#### **Span-by-span**

The span-by-span method is used for multi-span viaducts, where the individual span can be up to 60m.

These bridges are usually constructed in-situ with the false work moved forward span by span, but can be built of precast sections, put together as single spans and dropped into place, span by span.



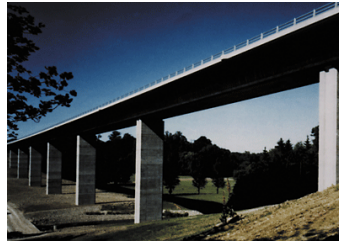

### **Balanced cantilever**

In the early 1950's, the German engineer Ulrich Finsterwalder developed a way of erecting prestressed concrete cantilevers segment by segment with each additional unit being prestressed to those already in position. This avoids the need for false work and the system has since been developed.



Whether created in-situ or using precast segments, the balanced cantilever is one of the most dramatic ways of building a bridge. Work starts with the construction of the abutments and piers. Then, from each pier, the bridge is constructed in both directions simultaneously. In this way, each pier remains stable - hence 'balanced' - until finally the individual structural elements meet and is connected together. In every case, the segments are progressively tied back to the piers by means of prestressing tendons or bars threaded through each unit.

### **Integral Bridges**

One of the difficulties in designing any structure is deciding where to put the joints. These are necessary to allow movement as the structure expands under the heat of the summer sun and contracts during the cold of winter. Expansion joints in bridges are notoriously prone to leakage. Water laden with road salts can then reach the tops of the piers and the abutments, and this can result in corrosion of all reinforcement. The expansive effects of rust can split concrete apart. In addition, expansion joints and bearings are an additional cost so more and more bridges are being built without either. Such structures, called 'integral bridges', can be constructed with all types of concrete deck. They are constructed with their decks connected directly to the supporting piers and abutments and with no provision in the form of bearings or expansion joints for thermal movement. Thermal movement of the deck is accommodated by flexure of the supporting piers and horizontal movements of the abutments, with elastic compression of the surrounding soil.



Already used for lengths up to 60m, the integral bridge is becoming increasingly popular as engineers and designers find other ways of dealing with thermal movement.

### **Cable-Stayed Bridges**

For really large spans, one solution is the cable-stayed bridge. These types of bridges first developed in west Germany. They consists of cables provided above the deck and are connected to the towers. The deck is either supported by a number cables meeting in a bunch at the tower or by joining at different levels on the tower. The multiple cables would facilitate smaller distance between points of supports for the deck girders. This results in reduction of structure depth. The cables can arrange in one plane or two planes. The two plane system requires additional widths to accommodate the towers and deck anchorages. Singly plane system requires less width of deck. Where all elements are concrete, the design consists of supporting towers carrying cables which support the bridge from both sides of the tower. Most cable-stayed bridges are built using a form of cantilever construction which can be either in-situ or precast.



The cable stayed bridges are similar to suspension bridges except that there are no suspenders in the cable stayed bridges and the cables are directly stretched from the towers to connect with decking. No special anchorage is required for the cables as incase of suspension bridges because the anchorage at one end is done in the girder and at the other on top of tower. The cable-stayed bridges have been found economical for up to span 300m. However due to cantilever effect their deflection is rather high and hence they are not preferred for very long span in railways.

### **Suspension Bridges**

Concrete plays an important part in the construction of a suspension bridge suspension bridgs are ideal solution for bridging gaps in hilly areas because of their construction technology and capacity of spanning large gaps. There will be massive foundations, usually embedded in the ground, that support the weight and cable anchorages .The cable takes shape of catenary between two points of suspension. The flooring of bridge supported by the cable by virtue of tension developed in its cross section. The vertical members are known as **suspenders** are provided to transfer load from bridge floor to suspension cable. There will also be the abutments, again probably

in mass concrete, providing the vital strength and ability to resist the enormous forces, and in addition, the slender superstructures carrying the upper ends of the supporting cables are also generally made from reinforced concrete.

Typical deck, through and semi-through type truss bridges

**(ii) Through Type Bridge** - The carriageway rests at the bottom level of the main load carrying members. In the through type plate girder bridge, the roadway or railway is placed at the level of bottom flanges. In the through type truss girder bridge, the roadway or railway is placed at the bottom chord level. The bracing of the top flange or lateral support of the top chord under compression is also required.

**(iii) Semi through Type Bridge** - The deck lies in between the top and the bottom of the main load carrying members. The bracing of the top flange or top chord under compression is not done and part of the load carrying system project above the floor level. The lateral restraint in the system is obtained usually by the U-frame action of the verticals and cross beam acting together.

### **Concrete bridges-**

They can be divided into the following main classes

- (1) Unstiffened suspension Bridges.
- (2) Stiffened suspension Bridges.

**Un-stiffened suspension Bridges:-** In case of Un-stiffened suspension Bridges the moving load is transferred direct to the cables by each suspender. These are used for light construction such as foot bridges forest train structures, etc where the moving load is negligible and deflection requirements are not controlling. Also the places where span is very long and the ratio dead to moving load intensity is so great to render stiffening unnecessary.



**Stiffened suspension Bridges:-** In stiffened type suspension Bridges moving loads are transformed to the cables through medium of trusses called **stiffening girders**. The stiffening girder assists the cable to become more rigid and prevent change in shape and gradient of roadway platform. It is therefore adopted for heavy traffic.

### **IRC Bridge loading:-**

The public roads in India are managed and controlled by the Government and hence bridges to be constructed for roads to be designed as per standards set up by standard authorities. For

highway bridges standard specifications are contained in the Indian Road Congress (I.R.C) Bridge code. In India, highway bridges are designed in accordance with IRC bridge code. IRC: 6 - 1966 – Section II gives the specifications for the various loads and stresses to be considered in bridge design. There are three types of standard loadings for which the bridges are designed namely,

- (a) IRC class AA loading,
- (b) IRC class A loading
- (c) IRC class B loading.

**IRC class AA loading:-**

IRC class AA loading consists of either a tracked vehicle of 70 tonnes or a wheeled vehicle of 40 tonnes with dimensions as shown in Fig. The units in the figure are mm for length and tonnes for load. Normally, bridges on national highways and state highways are designed for these loadings. Bridges designed for class AA should be checked for IRC class A loading also, since under certain conditions, larger stresses may be obtained under class A loading. Sometimes class 70 R loading given in the Appendix - I of IRC: 6 - 1966 - Section II can be used for IRC class AA loading. Class 70 R loading is not discussed further here.

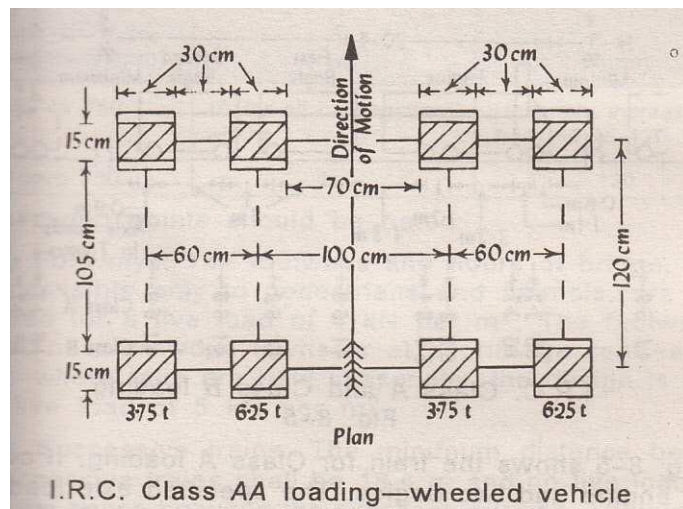

**IRC class A loading:-**Class A loading is based on heaviest type commercial vehicle consists of a wheel load train composed of a driving vehicle and two trailers of specified axle spacings. This loading is normally adopted on all roads on which permanent bridges are constructed.

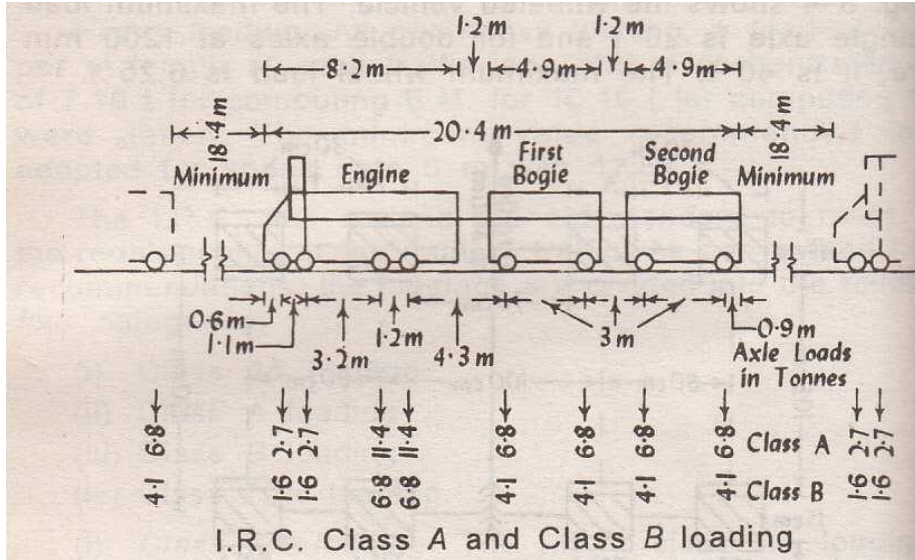

. **IRC class B loading**:-Class B loading is adopted for temporary structures and for bridges in specified areas. For class A and class B loadings, reader is referred to IRC: 6 - 1966 – Section II.

# CHAPTER-12

## CULVERTS AND CAUSE WAYS

**Culvert-** A culvert is defined as a small bridge constructed over a stream which remains dry most part of the year. It is across drainage work having total length not exceeding 6m between faces of abutment.

Types of Culverts;-

The following are six different type culvert.

1. Arch culvert
- 2.Box culvert
- 3.Pipe culvert
- 4.Slab culvert

**Arch culvert:-**

An arch culvert consists of abutments wing walls, arch, parapets and the foundation. The construction materials commonly used are brick work or concrete. Floor and curtain wall may or may not be provided depending upon the nature of foundation soil and velocity of flow. A typical arch culvert is shown in figure.

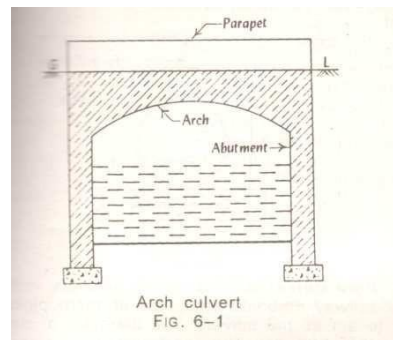

**Box culvert:-**

In case of box culvert the rectangular boxes are formed of masonry, R.C.C or steel. The R.C.C box culverts are very common and they consist of the following two component

- (i) The barrel or box section of sufficient length to accommodate the roadway and the Krebs.
- (ii) The wing walls splayed at 45 for retaining the embankment and also guiding the flow of water into and out of the barrel.

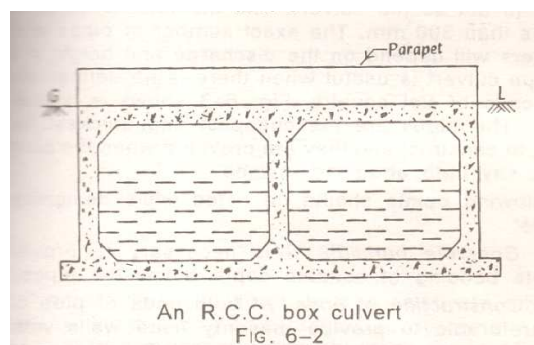

Fig. 6-2 shows an R.C.C box culvert with two openings. Following points should be noted.

- (i) Foundation: The box culverts prove to be safe where good foundations are easily available.
- (ii) Height: The clear vent height i.e. the vertical distance between top and bottom of the culvert rarely exceeds 3 meters.
- (iii) Sap: The box culverts are provided singly or in multiple units with individual span exceed about 6 m or so, it requires thick section which will make the construction uneconomical.
- (iv) Top: Depending upon the site conditions, the top level of box may be at the road level or it can even be at a depth below road level with filling of suitable material.

**Pipe Culvert:**

They are provided when discharge of stream is small or when sufficient headway is not available. Usually one or more pipes of diameter not less than 60cm are placed side by side. Their exact number and diameter depend upon the discharge and height of bank. For easy approach of water splayed type wing walls are provided in fig. 6.3 shows a Hume pipes culvert of single pipe. The pipes can be built of masonry. Stone ware, cement concrete, cast iron or steel. Concrete bedding should also be given below the pipes and earth cushion of sufficient thickness on the top to protect the pipes and their joints. For Economic reason road culverts should have non-pressure heavy duty pipes of type ISI class NP3 conforming to IS:458-1961. As far possible the gradient of the pipe should not be less than 1000.



**Slab Culvert:**

A slab culvert consists of stone slabs or R.C.C slab, suitably support on masonry walls on either side. As shown in fig 6-4. The slab culverts of simply type are suitable up to a maximum span of 2.50 m or so. However the R.C.C culverts of deck slab type can economically be adopted up to spans of about 8 m. However, the thickness of slab and dead weight may sometimes prove to be the limiting factors for deciding the economical span of this type of culverts.



The construction of slab culverts is relatively simple as the frame work can easily be arranged, reinforcement can be suitably placed and concreting can be done easily. This type of culvert can be used for highway as well as Railway Bridge. Depending upon the span of culvert and site conditions the abutment and wing walls of suitable dimensions may be provided. The parapet or hand rail of at least 750 mm height should be provided on the slab to define the width of culvert.

**CAUSEWAYS :**

A road causeway is a pucca dip which allows floods to pass over it. It may or may not have opening or vents for low water to flow. If it has vents for low water to flow then it is known as high level causeway or submersible bridge ; otherwise a low level causeway.

**TYPES OF CAUSEWAY:**

**A) Low level causeway:**

It is also known as Irish Bridge. The beds of small rivers or streams, which remain dry for most part of the year, are generally passable without a bridge. This involves heavy earth works in cutting for bridge approaches .Banks of such types of streams are cut down at an easy slope. For streams of rivers in plains having sandy beds, it is often sufficient to lay bundles of grass over and across the sandy track. The bundles may be of 20 to 25cm in diameter whose ends are secured by longitudinal fascines pegged down by stakes.

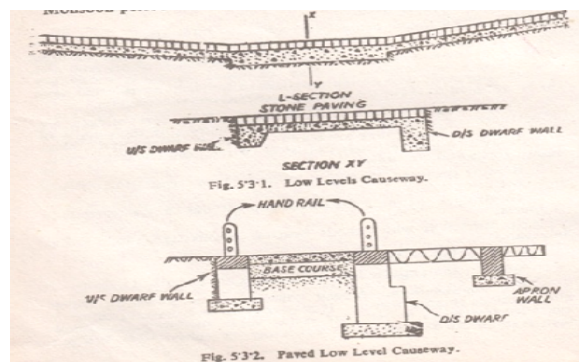

For crossings important from traffic point of view it is essential to lay a metal or pucca paving of stone or brick set in lime mortar on a substantial bed of concrete. To prevent against possible scour and undermining a cut off or dwarf wall usually 60cm deep on the upstream side and 120 to 150cm on downstream side is provided. Fig. 5.3.1 below shows the details of a typical Irish bridge.



The low level causeway could be provided with openings formed by concrete Hume pipes if there is a continuous flow stream during the monsoon periods.

**B) High level Causeway:**

A high level causeway is submersible road bridge designed to be overtopped in floods. Its formation level is fixed in such a way as not to cause interruption to traffic during floods for more than three days at a time not for more than six times in a year. A sufficient numbers of openings are provided to allow the normal flood discharge to pass through them with the required clearance. They are provided with abutments and piers, floors and slabs or arches to form the required number of openings. The slope of the approaches is kept as 1 in 20. When the velocity is high and stream bed is soft the aprons could be of concrete or harder masonry upto a certain distance. Similarly, the road can be formed of a cement concrete slab or stone blocks set in cement mortar. A typical type of high level causeway is shown in Fig.5.3.3. If railing are provided in the bridge, they should be of collapsible

type. Temporary causeways used for an emergency military operations are formed either by using

timber stringers and planking over cribs used as piers or by constructing a culvert using pipes.

